

ELECTRONIC CASH REGISTER

TK-T200

THANK YOU
YOUR RECEIPT
CALL AGAIN !
HAMBURGER
COFFEE
FRENCH
FRIED
SANDWICH
ICE CREAM



Eu Di U.K.

USER'S MANUAL

CASIO®

Safety Precautions

- To use this product safely and correctly, read this manual thoroughly and operate as instructed.
After reading this guide, keep it close at hand for easy reference.
Please keep all informations for future reference.
- Always observe the warnings and cautions indicated on the product.

About the icons

In this guide various icons are used to highlight safe operation of this product and to prevent injury to the operator and other personnel and also to prevent damage to property and this product. The icons and definitions are given below.



Indicates that there is a risk of severe injury or death if used incorrectly.



Indicates that injury or damage may result if used incorrectly.

Icon examples

To bring attention to risks and possible damage, the following types of icons are used.



The \triangle symbol indicates that it includes some symbol for attracting attention (including warning). In this triangle the actual type of precautions to be taken (electric shock, in this case) is indicated.



The \otimes symbol indicates a prohibited action. In this symbol the actual type of prohibited actions (disassembly, in this case) will be indicated.



The \bullet symbol indicates a restriction. In this symbol the type of actual restriction (removal of the power plug from an outlet, in this case) is indicated.

Warning!

Handling the register



Should the register malfunction, start to emit smoke or a strange odor, or otherwise behave abnormally, immediately shut down the power and unplug the AC plug from the power outlet. Continued use creates the danger of fire and electric shock.

- Contact CASIO service representative.



Do not place containers of liquids near the register and do not allow any foreign matter to get into it. Should water or other foreign matter get into the register, immediately shut down the power and unplug the AC plug from the power outlet. Continued use creates the danger of shorting, fire and electric shock.

- Contact CASIO service representative.



Should you drop the register and damage it, immediately shut down the power and unplug the AC plug from the power outlet. Continued use creates the danger of shorting, fire and electric shock.

- Attempting to repair the register yourself is extremely dangerous. Contact CASIO service representative.
-

Warning!



Never try to take the register apart or modify it in any way. High-voltage components inside the register create the danger of fire and electric shock.

- Contact CASIO service representative for all repair and maintenance.
-

Power plug and AC outlet



Use only a proper AC electric outlet (100V~240V) . Use of an outlet with a different voltage from the rating creates the danger of malfunction, fire, and electric shock. Overloading an electric outlet creates the danger of overheating and fire.



Make sure the power plug is inserted as far as it will go. Loose plugs create the danger of electric shock, overheating, and fire.

- Do not use the register if the plug is damaged. Never connect to a power outlet that is loose.
-



Use a dry cloth to periodically wipe off any dust built up on the prongs of the plug. Humidity can cause poor insulation and create the danger of electric shock and fire if dust stays on the prongs.



Do not allow the power cord or plug to become damaged, and never try to modify them in any way. Continued use of a damaged power cord can cause deterioration of the insulation, exposure of internal wiring, and shorting, which creates the danger of electric shock and fire.

- Contact CASIO service representative whenever the power cord or plug requires repair or maintenance.
-

Caution!



Do not place the register on an unstable or uneven surface. Doing so can cause the register — especially when the drawer is open — to fall, creating the danger of malfunction, fire, and electric shock.

Do not place the register in the following areas.



- Areas where the register will be subject to large amounts of humidity or dust, or directly exposed to hot or cold air.
- Areas exposed to direct sunlight, in a close motor vehicle, or any other area subject to very high temperatures.

The above conditions can cause malfunction, which creates the danger of fire.



Do not overlay bend the power cord, do not allow it to be caught between desks or other furniture, and never place heavy objects on top of the power cord. Doing so can cause shorting or breaking of the power cord, creating the danger of fire and electric shock.



Be sure to grasp the plug when unplugging the power cord from the wall outlet. Pulling on the cord can damage it, break the wiring, or cause short, creating the danger of fire and electric shock.



Never touch the plug while your hands are wet. Doing so creates the danger of electric shock. Pulling on the cord can damage it, break the wiring, or cause short, creating the danger of fire and electric shock.

Never touch the printer head and the platen.

Introduction & Contents

Introduction & Contents	4
Getting Started	7
Remove the cash register from its box.	7
Remove the tape holding parts of the cash register in place.	7
Install the three memory backup batteries.	7
Install receipt/journal paper.	9
Plug the cash register into a wall outlet.	11
Insert the mode key marked "PGM" into the mode switch.	11
Turn the mode key to the "REG" position.	11
Set the date.	12
Set the time.	12
Select printouts receipt or journal.	12
Tax table programming	13
Introducing TK-T200	17
General guide	17
Roll paper, Receipt On/Off key, Mode key, Drawer, Drawer lock	17
Mode switch, Lock/unlock the multipurpose tray	18
Displays	19
Keyboard	20
Basic Operations and Setups	22
How to read the printouts	22
How to use your cash register	23
Clerk sign on and sign off	24
Displaying the time and date	25
Preparing coins for change	25
Preparing and using department keys	26
Registering department keys	26
Programming department keys	27
Registering department keys by programming data	28
Preparing and using PLUs	29
Programming PLUs	29
Registering PLUs	30
Preparing and using flat-PLUs	31
Programming flat-PLUs	31
Registering flat-PLUs	32
Preparing and using discounts	33
Programming discounts	33
Registering discounts	34
Preparing and using reductions	35
Programming for reductions	35
Registering reductions	36
Registering credit and check payments	37
Registering returned goods in the REG mode	38
Registering returned goods in the RF mode	39
Registering money received on account	40
Registering money paid out	40
Making corrections in a registration	41
No sale registration	43
Printing the daily sales reset report	44
Convenient Operations and Setups	45
Post-finalization receipt format, General printing control, Compulsory, Machine features	45
About post-finalization receipt	45
Programming general printing control	46
Programming compulsory and clerk control function	47
Programming read/reset report printing control	48
Setting a store/machine number	48
Programming to clerk	49
Programming clerk number	49

Programming trainee status of clerk	49
Programming clerk commission rate	50
About the clerk interrupt function	50
Programming descriptors and messages	51
Programming report descriptor, grand total, special character, report title, receipt message and clerk name	51
Programming receipt message/logo stamp control function	53
Programming department key descriptor	53
Programming PLU descriptor	54
Programming flat-PLU descriptor	55
Programming function key descriptor	56
Entering characters	57
Using character keyboard	57
Entering characters by code	58
Department key feature programming	59
Batch feature programming	59
Individual feature programming	60
PLU feature programming	61
Batch feature programming	61
Individual feature programming	62
Flat-PLU feature programming	63
Batch feature programming	63
Individual feature programming	64
Percent key feature programming	67
Currency exchange programming	69
Currency exchange rate programming	69
Currency exchange feature programming	69
Registering foreign currency	70
Check tracking system	72
To use check tracking specification	72
The program controlling check tracking specifications	73
The program for new balance key	74
How to program set menu	75
How to program the condiment PLU and preparation PLU	76
The operations in the "Arrangement" key programming	77
Other function key feature programming	78
Cash, Charge, Check, Credit key	78
Received on account, Payout key	79
Minus, Plus key	79
#/No sale key	79
Tax shift key	79
Calculator functions	80
About the daylight saving time	81
Keyboard layout change	82
Programming the function of each key	82
Printing read/reset reports	84
Reading the cash register's program	90
Troubleshooting	94
When an error occurs	94
When the register does not operate at all	95
In case of power failure	96
When the L sign appears on the display	96
User Maintenance and Options	97
To replace journal paper	97
To replace receipt paper	98
Options	98
Specifications	99
Index	100

Unpacking the register

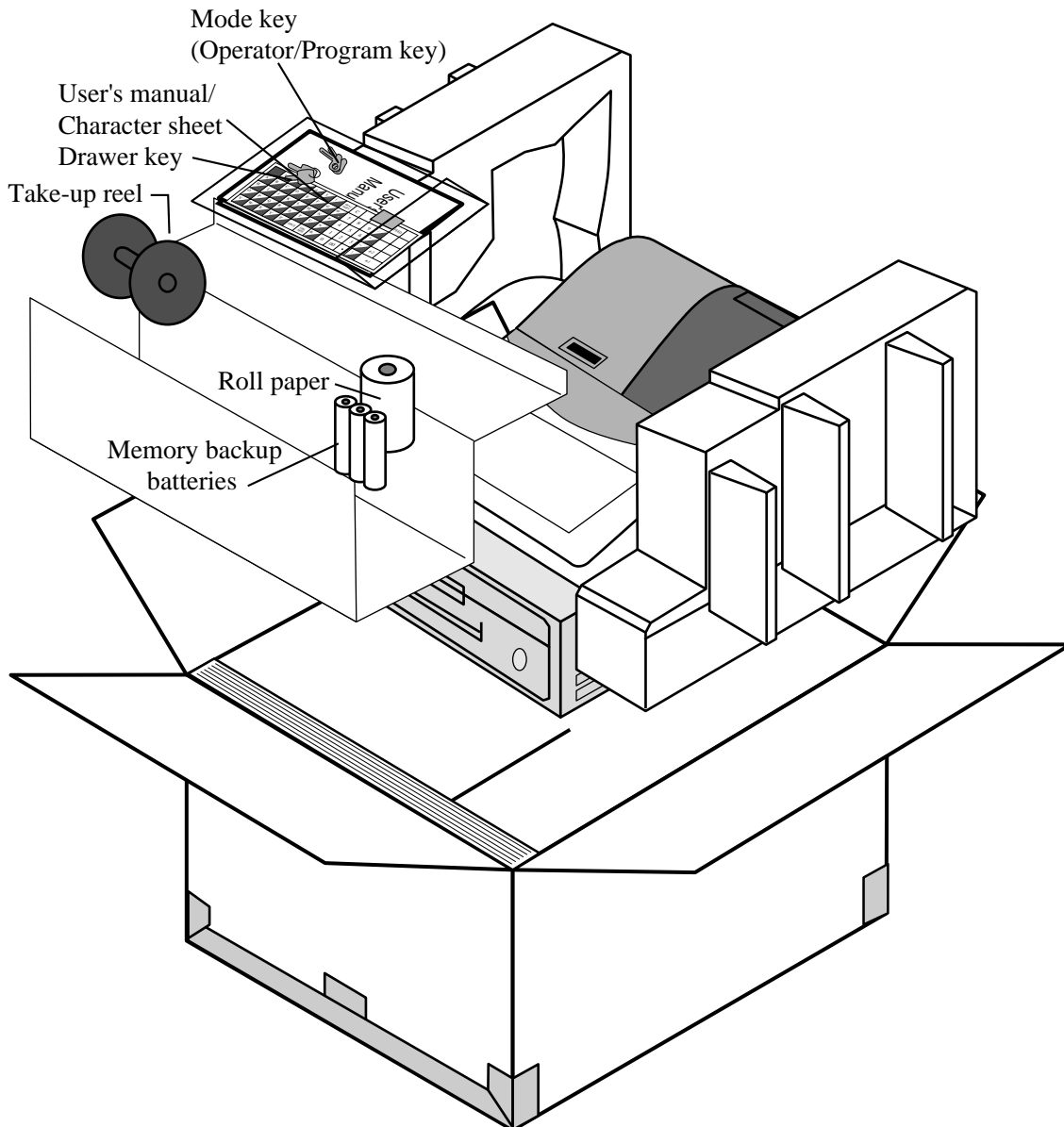

Welcome to the CASIO TK-T200!

Congratulations upon your selection of a CASIO Electronic Cash Register, which is designed to provide years of reliable operation.

Operation of a CASIO cash register is simple enough to be mastered without special training. Everything you need to know is included in this manual, so keep it on hand for reference.

Consult your CASIO dealer if you have any questions about points not specifically covered in this manual.

The main plug on this equipment must be used to disconnect main power.

Please ensure that the socket outlet is installed near the equipment and shall be easily accessible.

Please keep all information for future reference.

Getting Started

This section outlines how to unpack the cash register and get it ready to operate. You should read this part of the manual even if you have used a cash register before. The following is the basic set up procedure, along with page references where you should look for more details.

- 1. Remove the cash register from its box.**
Make sure that all of the parts and accessories are included.

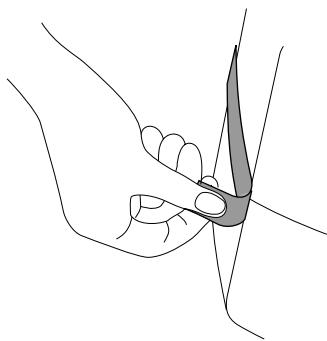
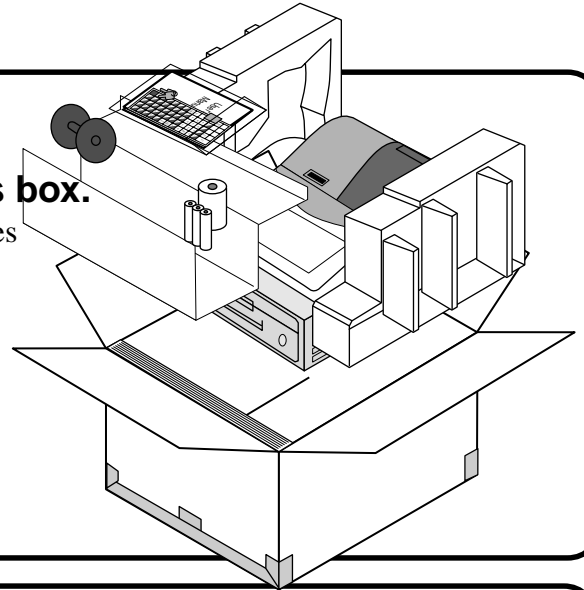

- 2. Remove the tape holding parts of the cash register in place.**

Also remove the small plastic bag taped to the printer cover. Inside you will find the mode keys.

- 3. Install the three memory backup batteries.**

1. Remove the printer cover and open the platen arm.



printer cover



platen arm



battery compartment cover

2. Remove the battery compartment cover. Slide the cover and pull it up.

3. Install the three memory backup batteries. (continued...)



3. Note the (+) and (-) markings in the battery compartment. Load a set of three new SUM-3 (UM-3) batteries so that their positive (+) and negative (-) ends are facing as indicated by the markings.



4. Replace the battery compartment cover.

5. Close the platen arm and replace the printer cover.

Important!

These batteries protect information stored in your cash register's memory when there is a power failure or when you unplug the cash register. Be sure to install these batteries.

Precaution!

Incorrectly using batteries can cause them to burst or leak, possibly damaging the interior of the cash register. Note the following.

- Be sure that the positive (+) and negative (-) ends of the batteries are facing as marked in the battery compartment when you load them into the unit.
- Never mix batteries of different types.
- Never mix old batteries with new ones.
- Never leave dead batteries in the battery compartment.
- Remove the batteries if you do not plan to use the cash register for long periods.
- Replace the batteries at least once a year, no matter how much the cash register is used during the period.

WARNING!

- Never try to recharge the batteries supplied with the unit.
- Do not expose batteries to direct heat, let them become shorted or try to take them apart.

Keep batteries out of the reach of small children. If your child should swallow a battery, consult a physician immediately.

4. Install receipt/journal paper.

Platen arm
Platen
Printer

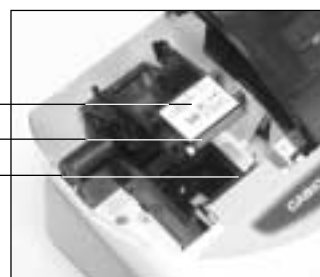

Important!

Take away the head protection sheet from the printer and close the platen arm.

Caution! (in handling the thermal paper)

- Never touch the printer head and the platen.
- Unpack the thermal paper just before your use.
- Avoid heat/direct sunlight.
- Avoid dusty and humid places for storage.
- Do not scratch the paper.
- Do not keep the printed paper under the following circumstances:
High humidity and temperature/direct sunlight/contact with glue, thinner or a rubber eraser.

To install receipt paper



Step 1

Remove the printer cover.



Step 4

Put the leading end of the paper over the printer.



Step 2

Open the platen arm.



Step 5

Close the platen arm slowly until it locks steadily.



Step 3

Ensuring the paper is being fed from the bottom of the roll, lower the roll into the space behind the printer.



Complete

Replace the printer cover, passing the leading end of the paper through the cutter slot. Tear off the excess paper.

To install journal paper



Step 1

Remove the printer cover.



Step 2

Open the platen arm.



Step 7

Slide the leading end of the paper into the groove on the spindle of the take-up reel and wind it onto the reel two or three turns.



Step 3

Ensuring the paper is being fed from the bottom of the roll, lower the roll into the space behind the printer.



Step 8

Replace the paper guide of the take-up reel.



Step 4

Put the leading end of the paper over the printer.



Step 9

Place the take-up reel into place behind the printer, above the roll paper.



Step 5

Close the platen arm slowly until it locks steadily.



Step 10

Press the **FEED** key to take up any slack in the paper.

During machine installation, press the **FEED** key after power on.



Step 6

Remove the paper guide of the take-up reel.



Complete

Replace the printer cover.

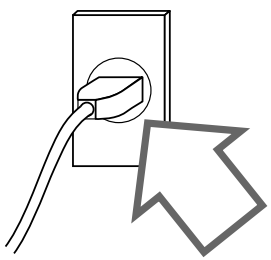

5. Plug the cash register into a wall outlet.

Be sure to check the sticker (rating plate) on the side of the cash register to make sure that its voltage matches that of the power supply in your area.

6. Insert the mode key marked "PGM" into the mode switch.

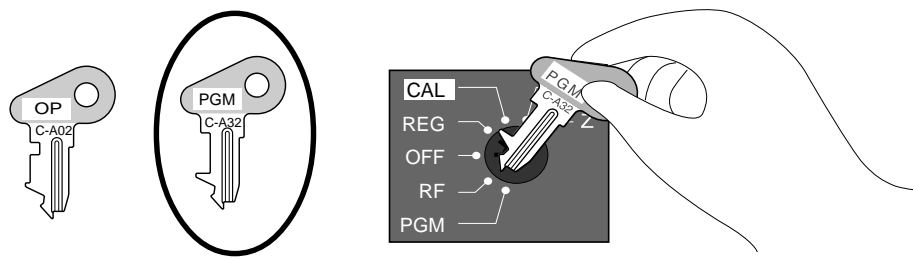

7. Turn the mode key to the "REG" position.

The display should change to the following.

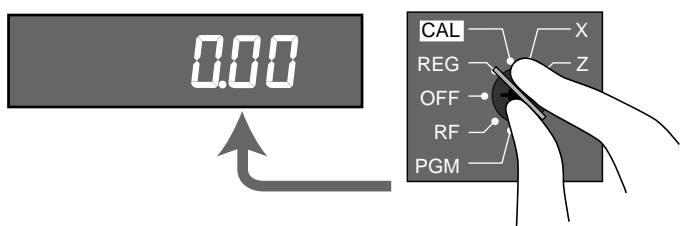

8. Set the date.

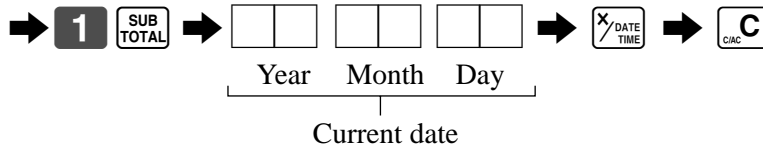
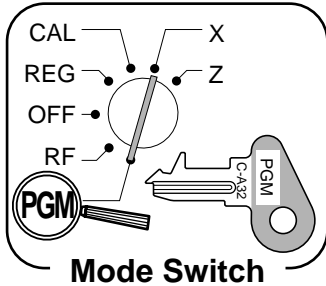

Example:

15, March 2002 ⇨ 0 2 0 3 1 5

9. Set the time.

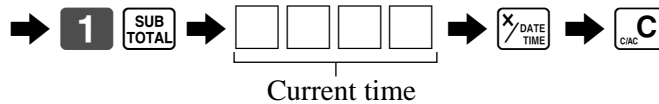
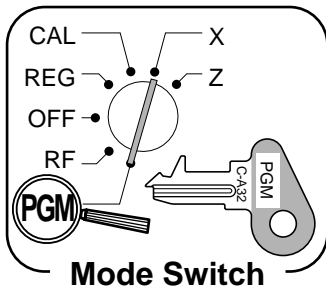

Example:

08:20 AM ⇨ 0 8 2 0

09:45 PM ⇨ 2 1 4 5

10. Select printouts receipt or journal.

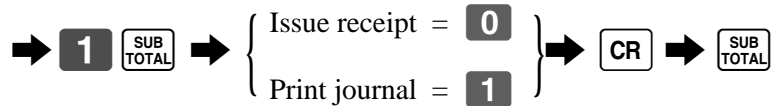
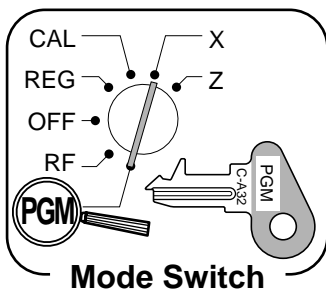

Note !

If you need journal and are sometimes required receipts by customers, select "issue receipt". After business hours, issue the electronic journal report.

11. Tax table programming

This cash register is capable of automatically calculating up to four different sales taxes. The sales tax calculations are based on rates, so you must tell the cash register the rates, the type of tax (add-in or add-on), and the type of rounding to apply. Note that special rounding methods (page 15) are also available to meet certain local tax requirements.

Important!

After you program the tax calculations, you also have to individually specify which departments (page 27) and PLUs (page 29, 31) are to be taxed.

Programming tax calculations (without special rounding)

Prepare the following subjects:

1. Tax rates
2. Rounding method for tax calculation
(Round up/Round off/Cut off)
3. Tax calculation system (Add-on/Add-in)

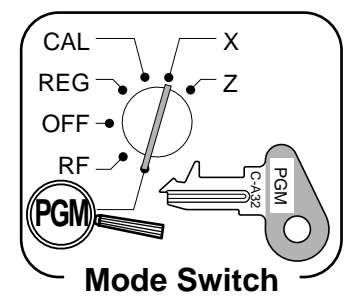

Programming procedure

Assign tax table 1.>

- Assigning tax table 2, enter 0 2 2 5 .
- Assigning tax table 3, enter 0 3 2 5 .
- Assigning tax table 4, enter 0 4 2 5 .

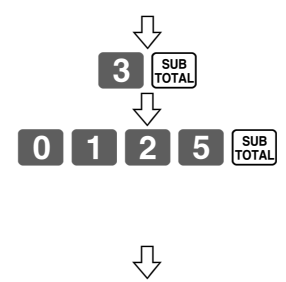

Enter tax rate (2 integers and 4 decimals)..

- Example: 15% = 1 5
- 8.25% = 8 . 2 5



Enter rounding method, tax calculation method..

Fraction round up	9	0		
Fraction round off	5	0		
Fraction cut off	0	0		
Always "0"			0	
Add-on tax				2
Add-in tax				3

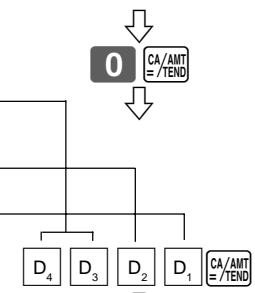

Terminate the procedure..>



11. Tax table programming (continued...)

Programming tax calculations (with special rounding)

Prepare the following subjects:

1. Tax rates
2. Rounding method for tax calculation (Round up/Round off/Cut off)
3. Tax calculation system (No/Add-on/Add-in)
4. Rounding system (Special rounding 1/Special rounding 2/Special rounding 3/Danish rounding /Australian rounding) :only effective for Tax Table 1

Programming procedure

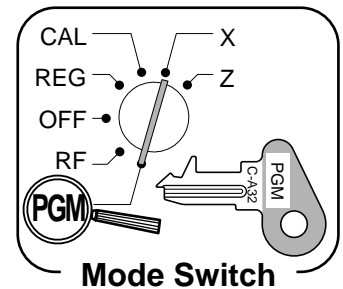

Mode Switch

Assign tax table 1. →

Assigning tax table 2, enter **0 2 2 5**.
 Assigning tax table 3, enter **0 3 2 5**.
 Assigning tax table 4, enter **0 4 2 5**.

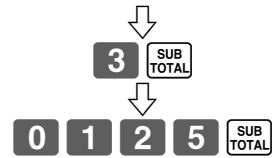

Enter tax rate (2 integers and 4 decimals)

Example: 15% = **1 5**
 8.25% = **8 . 2 5**
 non tax = **0**

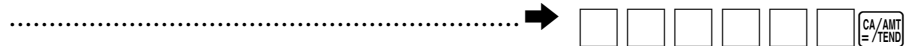

Enter rounding method, tax calculation method..

Fraction round up	9	0		
Fraction round off	5	0		
Fraction cut off	0	0		
Special rounding 1 *			1	
Special rounding 2 *			2	
Special rounding 3 *			6	
Special rounding 4 *			3	
Special rounding 5 *			7	
Add-on tax				2
Add-in tax				3

* See the next page.

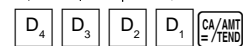
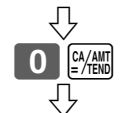

Terminate the procedure. →



11. About special rounding...

Besides cut off, round off and round up, you can also specify “special rounding” for subtotals and totals or changes. Special rounding converts the right-most digit(s) of an amount to “0” or “5” to comply with the requirements of certain areas.

1 Special Rounding 1

Last (right-most) digit		Rounding result	Examples:
0 ~ 2	⇒	0	1.21 → 1.20
3 ~ 7	⇒	5	1.26 → 1.25
8 ~ 9	⇒	10	1.28 → 1.30

2 Special Rounding 2

Last (right-most) digit		Rounding result	Examples:
0 ~ 4	⇒	0	1.12 → 1.10
5 ~ 9	⇒	10	1.55 → 1.60

3 Special Rounding 3

Last (right-most) digits		Rounding result	Examples:
00 ~ 24	⇒	0	1.24 → 1.00
25 ~ 74	⇒	50	1.52 → 1.50
75 ~ 99	⇒	100	1.77 → 2.00

4 Special Rounding 4 (Danish Rounding)

With Danish rounding, the rounding method applies to subtotals depends on whether you finalize the transaction by inputting an amount tendered or not.

- When a finalization is performed without an amount tendered entry
- When a finalization is performed with an amount tendered entry

Last (right-most) 2 digits of subtotal		Rounding result	Last (right-most) 2 digits of change due		Rounding result
00 ~ 12	⇒	00	00 ~ 12	⇒	00
13 ~ 37	⇒	25	13 ~ 37	⇒	25
38 ~ 62	⇒	50	38 ~ 62	⇒	50
63 ~ 87	⇒	75	63 ~ 87	⇒	75
88 ~ 99	⇒	100	88 ~ 99	⇒	100

5 Special Rounding 5 (Australian Rounding)

Last (right-most) digit		Rounding result	Examples:
0 ~ 2	⇒	0	1.21 → 1.20
3 ~ 7	⇒	5	1.26 → 1.25
8 ~ 9	⇒	10	1.28 → 1.30



- Partial tenders (payments): for Danish Rounding

No rounding is performed for the amount of tendered nor for the change amount due when the customer makes a partial tender. When a partial tender results in a remaining balance within the range of 1 through 12, the transaction is finalized as if there was no remaining balance.

- Display and printing of subtotals: for Danish and Australian Rounding

When you press the  key, the unrounded subtotal is printed and shown on the display. If the cash register is also set up to apply an add-on tax rate, the add-on tax amount is also included in the subtotal that is printed and displayed.

Important!

When you are using Danish rounding, you can use the  key to register tendered amount in which the last (right-most) digits are 00, 25, 50 or 75. This restriction does not apply to the  and  keys.

12. For Australia only

You can set some programmable options to suit the Australian GST by the following procedure.

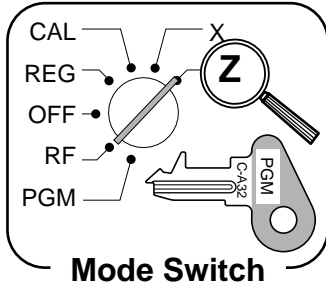

After completion of this procedure, the “GST system was changed” message was printed on receipt and;

- 1 Tax symbol (*) is printed.
- 2 Taxable amount is skipped.
- 3 “GST INCLUDED” is set to the TX1 descriptor.
- 4 “TAXABLE AMT” is set to the TA1 descriptor.
- 5 Total line is printed even in direct (cash) sale.
- 6 Australian rounding is set.
- 7 “\$” is set to the monetary symbol.
- 8 Print “MOF message” on receipt.
- 9 Tax (10% tax rate, add-in tax, fraction round off) is set to the tax table 1.
No data is set to other tax tables.
- O The taxable amount and tax amount except TA1/TX1 are not printed on report.
- A Restriction (to 0, 5) on last amount digit of cash sales, received on account, paid out, and money declaration.

* Sign on operation (page 24) is necessary before this operation.

Introducing TK-T200

General guide

This part of the manual introduces you to the cash register and provides a general explanation of its various parts.



Roll paper

You can use the roll paper to print receipts and a journal (page 9 ~ 10).

Receipt On/Off key

When you are using the printer for receipt printer, you can use this key (in the REG and RF modes only) to turn the printer on and off. If a customer asks for a receipt while receipt printing is turned off by this key, you can issue a post-finalization receipt (page 45).

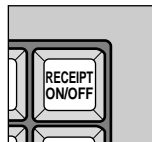

Mode key

There are two types of mode keys: the program key (marked "PGM") and the operator key (marked "OP"). The program key can be used to set the mode switch to any position, while the operator key can select the REG, CAL and OFF position.

Drawer

The drawer opens automatically whenever you finalize a registration and whenever you issue a read or reset report. The drawer will not open if it is locked with the drawer key.

Drawer lock

Use the drawer key to lock and unlock the drawer.

Multipurpose tray

This tray can always be opened if the locking knob is in the unlock position.

Use the locking knob to lock and unlock this tray.

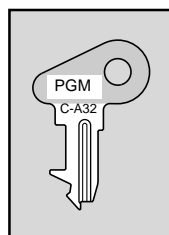

Program key

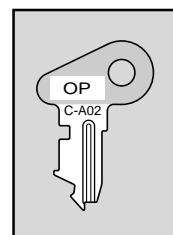

Operator key

Introducing TK-T200

Mode switch

Use the mode keys to change the position of the mode switch and select the mode you want to use.

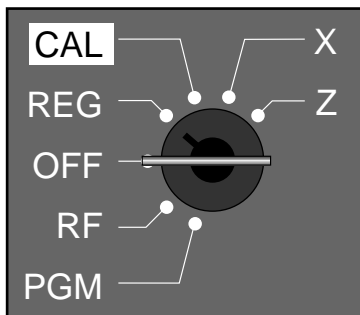

Mode Switch	Mode Name	Description
Z	RESET	Reads sales data in memory and clears the data.
X	READ	Reads sales data in memory without clearing the data.
CAL	CALCULATOR	Use this mode for calculator.
REG	REGISTER	Use this mode for normal registration.
OFF	STAND-BY	Cash register standing by.
RF	REFUND	Use this mode to register refund transaction.
PGM	PROGRAM	Use this mode for cash register programming.

Lock/unlock the multipurpose tray

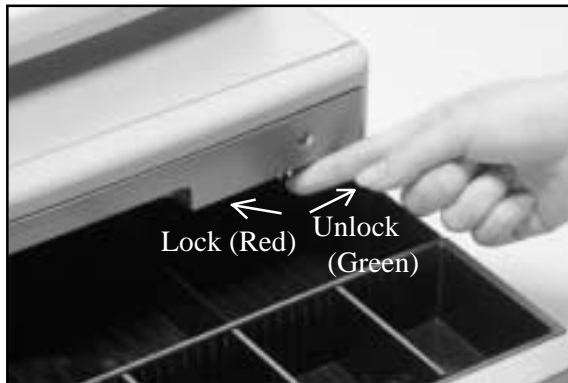

When the cash drawer does not open!

In case of power failure or the machine is in malfunction, the cash drawer does not open automatically. Even in these cases, you can open the cash drawer by pulling drawer release lever (see below).

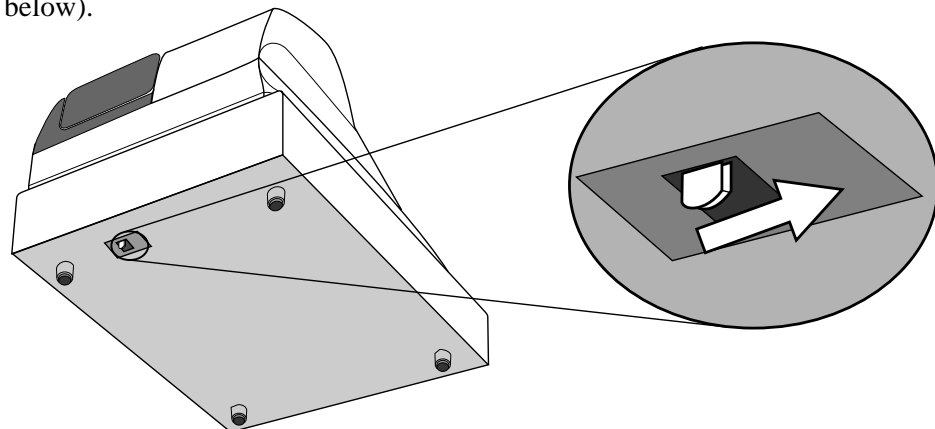

Important!

The drawer will not open, if it is locked with a drawer lock key.

Displays

Main Display

(alphanumeric + numeric display)

Pop-up (customer) display

(numeric display)

Item registration (by department/PLU)

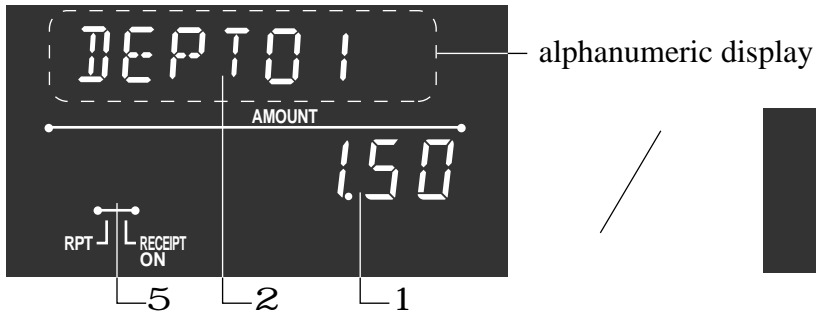

Repeat registration

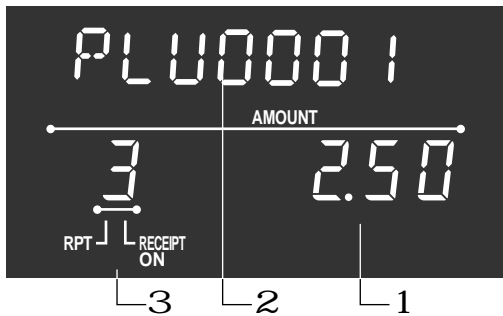

Totalize operation

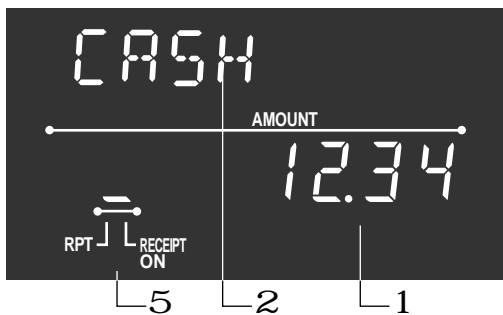

1 Amount/Quantity

This part of the display shows monetary amounts. It also can be used to show the current time. (The current date is shown in the alphanumeric display.)

2 Item/Key descriptor

When you register an item or key, the item/key descriptor appears here. Mode descriptor is also displayed here.

3 Number of repeats

Anytime you perform a repeat registration (page 26, 30), the number of repeats appears here.

Note that only one digit is displayed for the number of repeats. This means that a "5" could mean 5, 15 or even 25 repeats.

4 Total/Change indicators

When the TOTAL indicator is lit, the displayed value is monetary total or subtotal amount.

When the CHANGE indicator is lit, the displayed value is the change due.

5 Receipt on/off indicators

When the register is in "issuing receipt" mode, under-bar sign is lit on this digit. (REG/RF mode, during standing-by only)

Introducing TK-T200

Keyboard

1	5	10	15	20	25	30	GUEST/ POST RECEIPT	MENU SHIFT	C C/AC	X DATE TIME	OPEN CLK#	PLU	FEED	RECEIPT ON/OFF
4	9	14	19	24	29	O	%	A ADD/ PRICE	B 7	8	9	÷ 4	RC MR	PD
3	8	13	18	23	28	F	—	G OLD	4	5	6	× 3	H #/ NS	I CHK
2	7	12	17	22	27	J	RF	K NEW	1	2	3	- 2	L SUB TOTAL	M CR
1	6	11	16	21	26	N	ERR.CORR CANCEL	O NB	0	00	•	+ 1	P CA/ AMT TEND	

• Register Mode

1 Flat PLU key ~

Use these keys to register items to flat PLUs.

2 Guest/Post receipt key

Guest receipt key: Use this key to produce a guest receipt (page 73) in a check tracking system.

Post receipt key: Use this key to produce a post-finalization receipt (page 45).

3 Menu shift key

Use this key to shift the flat PLU key number from 1 through 30 to 31 through 60 or 61 through 90.

<input type="text" value="1"/>	⇒ 1,	<input type="text" value="MENU SHIFT"/>	<input type="text" value="1"/>	⇒ 31,	<input type="text" value="MENU SHIFT"/>	<input type="text" value="MENU SHIFT"/>	<input type="text" value="1"/>	⇒ 61
<input type="text" value="2"/>	⇒ 2,	<input type="text" value="MENU SHIFT"/>	<input type="text" value="2"/>	⇒ 32,	<input type="text" value="MENU SHIFT"/>	<input type="text" value="MENU SHIFT"/>	<input type="text" value="2"/>	⇒ 62
⋮	⋮	⋮	⋮	⋮	⋮	⋮	⋮	⋮
<input type="text" value="30"/>	⇒ 30,	<input type="text" value="MENU SHIFT"/>	<input type="text" value="30"/>	⇒ 60,	<input type="text" value="MENU SHIFT"/>	<input type="text" value="MENU SHIFT"/>	<input type="text" value="30"/>	⇒ 90

4 Clear key

Use this key to clear an entry that has not yet been registered.

5 Multiplication/Date/Time key

Use this key to input a quantity for a multiplication operation. Between transactions, this key displays the current time and date.

6 Open/Clerk number key

This key is initialized as Clerk number key.

Clerk number key: Use this key to sign clerk on and off the register.

Open key: Use this key to temporarily release a limitation on the number of digits that can be input for a unit price. In case of using "Open" function, allocate "Open" key by programming.

7 PLU key

Use this key to input PLU (subdepartment) numbers.

8 Paper feed key

Hold this key down to feed paper from the printer.

9 Receipt on/off key

Use this key twice to change the status "receipt issue" or "no receipt". This key is only effective when the "use printer for receipt printer" in the printer control program is selected. In case of "receipt issue", the "RECEIPT ON" indicator is lit.

O Discount key

Use this key to register discounts.

A Add/Price key

Add check key: Use this key to combine the details of more than one check into a single check in a check tracking system.

Price key: Use this key to register unit prices for subdepartment.

B Ten key pad ~

Use these keys to input numbers.

C Department keys and

Use these keys to register items to departments.

D Received on account key

Use this key following a numeric entry to register money received for non-sale transactions.

E Paid out key

Use this key following a numeric entry to register money paid out from the drawer.

F Minus key 

Use this key to input values for subtraction.

G Old check key 

In a check tracking system, use this key to input the number of an existing check (previously created using the  key) whose details are stored in the check tracking memory. Existing checks are reopened to perform further registration or to finalize them.

H Non-add/No sale key 

Non-add key: To print reference number (to identify a personal check, credit card, etc.) during a transaction, use this key after some numerical entries.

No sale key: Use this key to open the drawer without registering anything.

I Check key 

Use this key to register a check tender.

J Refund key 

Use this key to input refund amounts and void certain entries.

K New check key 

In a check tracking system, use this key to input a new check number in order to open a new check under that number.

L Subtotal key 

Use this key to display and print the current subtotal (includes add-on tax) amount.

M Credit key 

Use this key to register a credit sale.

N Error correct/Cancel key 

Use this key to correct registration errors and to cancel registration of entire transactions.

O New balance key 

In a check tracking system, use this key to add latest registered total to the previous balance to obtain a new balance.

P Cash amount tendered key 

Use this key to register a cash sale.

• Calculator Mode

4 Clear/All clear key **O Percent key** **B Ten key pad** **C Arithmetic operation key** **D Memory recall key** **H Drawer open key** **P Equal key** 

How to read the printouts

- The journal and receipts are records of all transactions and operations.
- The contents printed on receipts and journal are identical, except the date printing line. (The date line is printed on receipts and reports.)
- You can choose the journal skip function (page 46).
If the journal skip function is selected, the cash register will print the total amount of each transaction, and the details of premium, discount and reduction operations only, without printing department and PLU item registrations on the journal.
- The following items can be skipped on receipts and journal.
 - Time
 - Consecutive number
 - Taxable status
 - Taxable amount

Receipt Sample

```

*****
*                               *
*   * THANK YOU *               *
**  CALL AGAIN **              *
*                               *
*****
* COMMERCIAL MESSAGE *
* COMMERCIAL MESSAGE *
* COMMERCIAL MESSAGE *
* COMMERCIAL MESSAGE *
* COMMERCIAL MESSAGE *
REG 15-03-2002 12:34
CLERK 01 0001-000123

DEPT01 T1 .1.00
DEPT02 T1 .2.00
5 X @1.00
DEPT03 T2 .5.00
TAX-AMT 1 .3.00
TAX 1 5% .0.15
TAX-AMT 2 .5.00
TAX 2 4% .0.20
TAX .0.35
TOTAL .8.35
CASH .10.00
CHANGE .1.65

7 No
*** BOTTOM MESSAGE ***
*** BOTTOM MESSAGE ***
*** BOTTOM MESSAGE ***
*** BOTTOM MESSAGE ***
    
```

Logo message or graphic logo

Commercial message

Mode/Date/Time
Clerk/Machine No.
-Consecutive No.

Taxable amount with tax rate

Tax total

Item counter

Bottom message

**Journal Sample
(Item lines Included)
(normal height)**

```

REG 12:33
CLERK 01 0001-000122
DEPT01 T1 .1.00
DEPT02 T1 .2.00
TAX-AMT 1 .3.00
TAX 1 .0.15
TAX .0.15
CASH .3.15

REG 12:34
CLERK 01 0001-000123
DEPT01 T1 .1.00
DEPT02 T1 .2.00
5 X @1.00
DEPT03 T2 .5.00
TAX-AMT 1 .3.00
TAX 1 5% .0.15
TAX-AMT 2 .5.00
TAX 2 4% .0.20
TAX .0.35
TOTAL .8.35
CASH .10.00
CHANGE .1.65

7 No
REG 12:35
CLERK 01 0001-000124
DEPT01 T1 .1.00
DEPT02 T1 .2.00
5 X @1.00
DEPT03 T2 .5.00
    
```

**Journal Sample
(Item lines Skipped)
(half height)**

```

REG 15-03-2002 12:32
CLERK 01 0001-000121
TAX 1 5% .3.00
TAX .0.15
CASH .3.15

2 No
REG 15-03-2002 12:33
CLERK 01 0001-000122
TAX-AMT 1 .3.00
TAX 1 5% .0.15
TAX .0.15
CA -3.15

2 No
REG 15-03-2002 12:34
CLERK 01 0001-000123
TAX-AMT 1 .3.00
TAX 1 5% .0.15
TAX-AMT 2 .5.00
TAX 2 4% .0.20
TAX .0.35
TOTAL .8.35
CASH .10.00
CHANGE .1.65

7 No
REG 15-03-2002 12:35
CLERK 01 0001-000124
TAX-AMT 1 .3.00
TAX 1 5% .0.15
TAX-AMT 2 .5.00
TAX 2 4% .0.20
    
```

In the operation examples contained in this manual, the print samples are what would be produced if the roll paper is being used for receipts. They are not actual size. Actual receipts are 58 mm wide. Also, all sample receipts and journals are printout images.

How to use your cash register

The following describes the general procedure you should use in order to get the most out of your cash register.

BEFORE business hours...

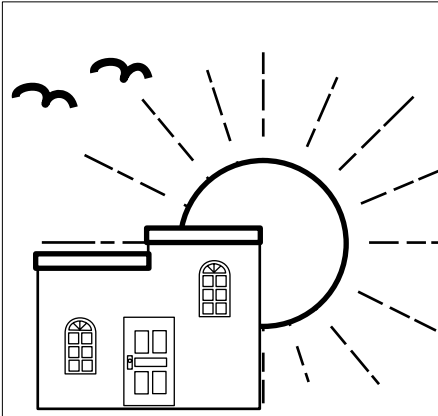

- Check to make sure that the cash register is plugged in securely. Page 11
- Check to make sure there is enough paper left on the roll. Page 9, 10
- Read the financial totals to confirm that they are all zero. Page 85
- Check the date and time. Page 25

DURING business hours...

- Register transactions. Page 26
- Periodically read totals. Page 84

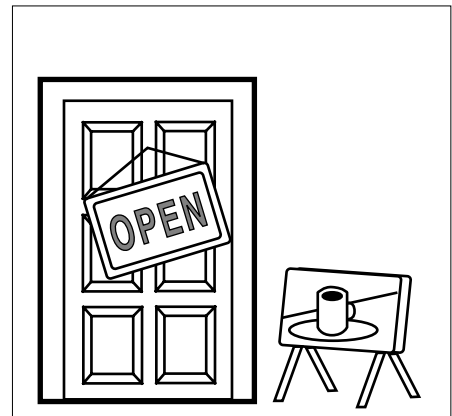

AFTER business hours...

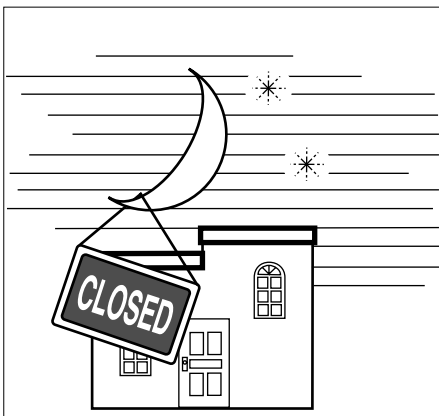

- Issue electronic journal report. (if necessary) Page 87
- Reset the daily totals. Page 44
- Remove the journal. Page 97
- Empty the cash drawer and leave it open. Page 18
- Take the cash and journal to the office.

Basic Operations and Setups

Clerk sign on and sign off

Any time you begin any registration or program, clerk sign on operation is necessary.

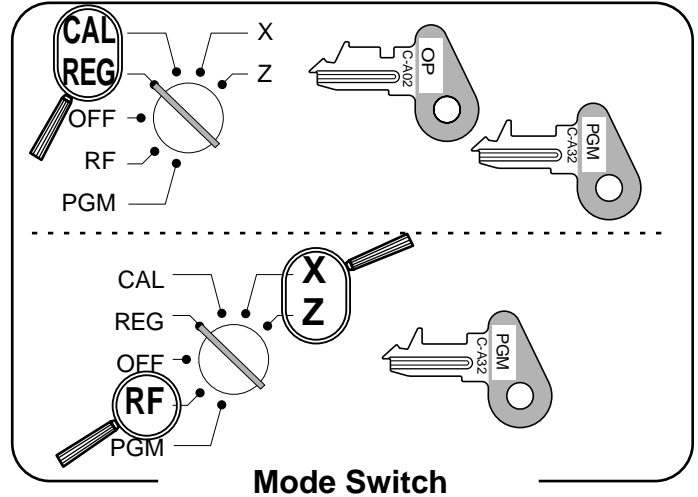

Clerk sign on

	OPERATION	RECEIPT
Signing clerk 1 on:	1 →	<pre> REG 15-03-2002 08:35 CLERK 01 000001 Clerk name/consecutive No. DEPT01 .1.00 DEPT02 .2.00 DEPT03 5 X @1.00 DEPT03 .5.00 </pre>
Signing clerk 2 on:	2 →	
Signing clerk 20 on:	2 0 →	

Clerk sign off

	OPERATION
Signing clerk off:	0 →

- The current clerk is also signed off whenever you set the mode switch to OFF position.

Important!

- The error code "E08" appears on the display whenever you try to perform a registration, a read/reset operation without signing on.
- The signed on clerk is also identified on the receipt/journal.
- The clerk numbers are initialized as 1 through 20. In case of using other clerk number, see page 49 for programming.

Displaying the time and date

You can show the time and date on the display of the cash register whenever there is no registration being made.

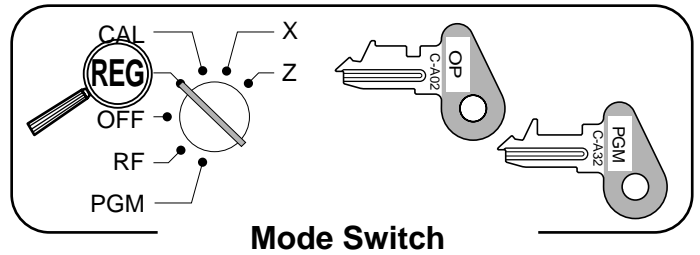

To display and clear the time and date

OPERATION

DISPLAY



Day Month Year

Hour Minutes.
(24-hour system)



Preparing coins for change

You can use the following procedure to open the drawer without registering an item. This operation must be performed out of a sale.

(You can use the **RC** key instead of the **#/NS** key. See page 40.)

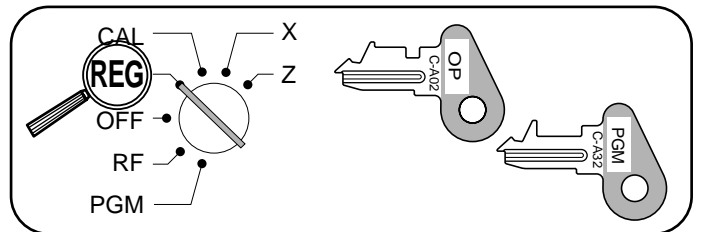

Opening the drawer without a sale

OPERATION

RECEIPT

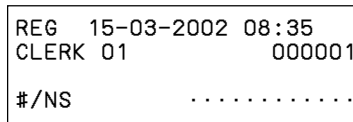

Preparing and using department keys

Registering department keys

The following examples show how you can use the department keys in various types of registrations.

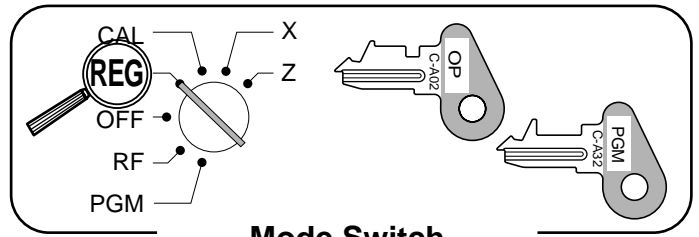

Single item sale

OPERATION

RECEIPT

Item	Unit price	\$1.00
	Quantity	1
	Dept.	1
Payment	Cash	\$1.00

1 00
 Unit price
+ 1
 Department
CA/AMT = /TEND

REG	15-03-2002	08:40	Mode/date/time
CLERK	01	000002	Clerk/consecutive No.
DEPT01		. 1.00	Department descriptor/unit price
CASH		. 1.00	Cash total amount

Repeat

OPERATION

RECEIPT

Item	Unit price	\$1.50
	Quantity	3
	Dept.	1
Payment	Cash	\$10.00

1 5 0 **+ 1**
+ 1
+ 1
SUB TOTAL
1 0 00 **CA/AMT = /TEND**

REG	15-03-2002	08:45	
CLERK	01	000003	
DEPT01		. 1.50	Repeat
DEPT01		. 1.50	Repeat
DEPT01		. 1.50	
TOTAL		. 4.50	
CASH		. 10.00	
CHANGE		. 5.50	

Multiplication

OPERATION

RECEIPT

Item	Unit price	\$1.00
	Quantity	12.5
	Dept.	1
Payment	Cash	\$20.00

1 2 . 5 **% DATE TIME**
 Quantity (4-digit integer/2-digit decimal)
1 00 **+ 1**
SUB TOTAL
2 0 00 **CA/AMT = /TEND**

REG	15-03-2002	08:50	
CLERK	01	000004	
12.5	X	@1.00	Quantity/unit price
DEPT01		. 12.50	
TOTAL		. 12.50	
CASH		. 20.00	
CHANGE		. 7.50	

Programming department keys

To program a unit price for each department

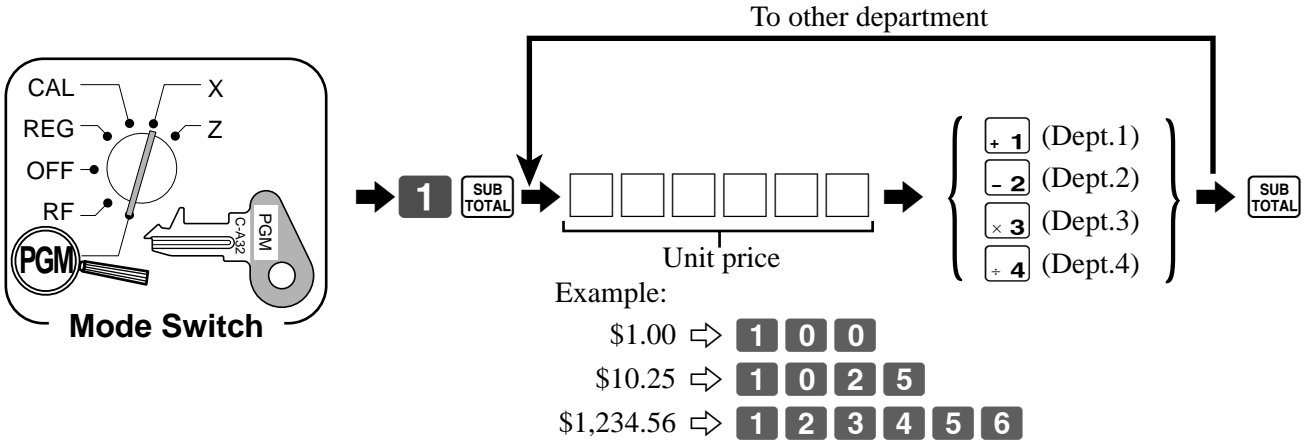

To program the tax calculation status for each department

Tax calculation status

This specification defines which tax table should be used for automatic tax calculation. See page 13 for information on setting up the tax tables.

Programming procedure

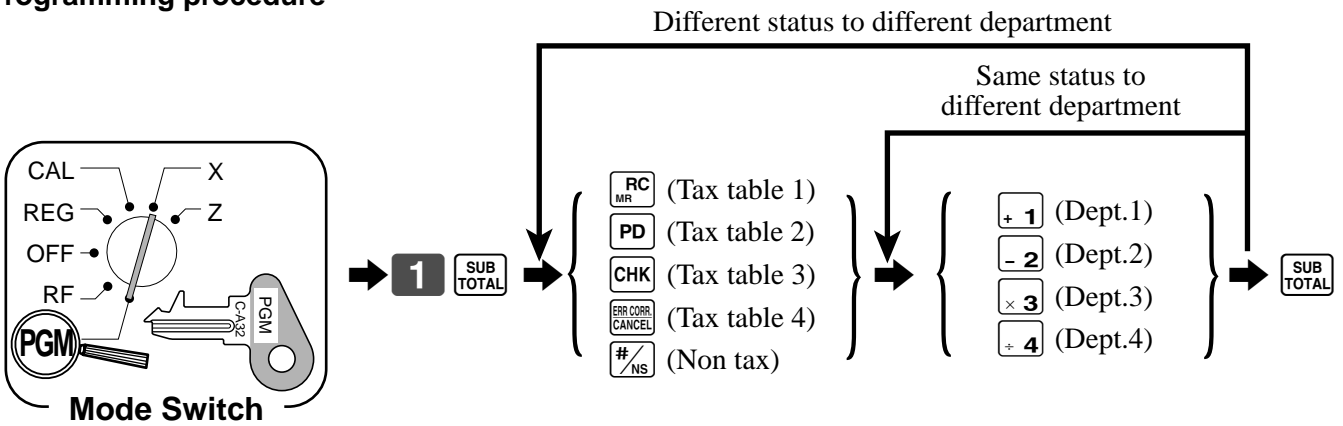

Note: Tax symbols

T1: Tax table 1

T2: Tax table 2

T3: Tax table 3

T4: Tax table 4

All departments are initialized as non-tax.

Basic Operations and Setups

Registering department keys by programming data

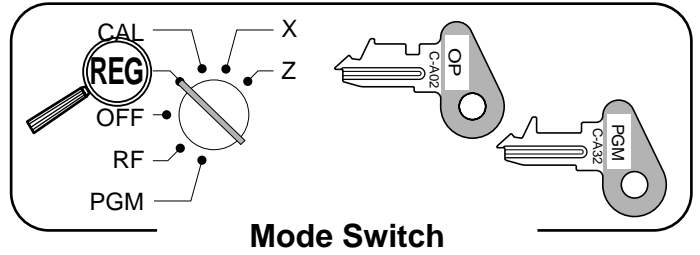

Preset price

OPERATION

Item	Unit price	(\$1.00)
	Quantity	1
	Dept.	2
Payment	Cash	\$1.00

(): Preset value

- 2

CA/AMT
=/TEND

Mode Switch

RECEIPT

REG	15-03-2002	08:55
CLERK	01	000005
DEPT02		. 1.00
CASH		. 1.00

Department descriptor/unit price

Preset tax status (Add-on tax)

OPERATION

Item 1	Unit price	(\$2.00)
	Quantity	5
	Dept.	3
	Taxable	(1)
Item 2	Unit price	(\$2.00)
	Quantity	1
	Dept.	4
	Taxable	(2)
Payment	Cash	\$20.00

(): Preset value

5

X/DATE
TIME

x 3

÷ 4

SUB
TOTAL

2 0 00

CA/AMT
=/TEND

RECEIPT

REG	15-03-2002	09:00
CLERK	01	000006
5	X	@2.00
DEPT03		. 10.00
DEPT04		. 2.00
TAX-AMT 1		. 10.00
TAX 1		. 0.50
TAX-AMT 2		. 2.00
TAX 2		. 0.12
TOTAL		. 12.62
CASH		. 20.00
CHANGE		. 7.38

Tax status symbols *

Taxable Amount 1
Tax 1
Taxable Amount 2
Tax 2

* To print tax status symbols, please refer to page 46.

Preset tax status (Add-in tax)

OPERATION

Item 1	Unit price	(\$2.00)
	Quantity	5
	Dept.	3
	Taxable	(1)
Item 2	Unit price	(\$2.00)
	Quantity	1
	Dept.	4
	Taxable	(2)
Payment	Cash	\$20.00

(): Preset value

5

X/DATE
TIME

x 3

÷ 4

SUB
TOTAL

2 0 00

CA/AMT
=/TEND

RECEIPT

REG	15-03-2002	09:05
CLERK	01	000007
5	X	@2.00
DEPT03		. 10.00
DEPT04		. 2.00
TOTAL		. 12.00
CASH		. 20.00
CHANGE		. 8.00

Tax status symbols *

* To print tax status symbols, please refer to page 46.

Preparing and using PLUs

This section describes how to prepare and use PLUs.

CAUTION:

Before you use PLUs, you should first tell the cash register how it should handle the registration.

Programming PLUs

To program a unit price for each PLU

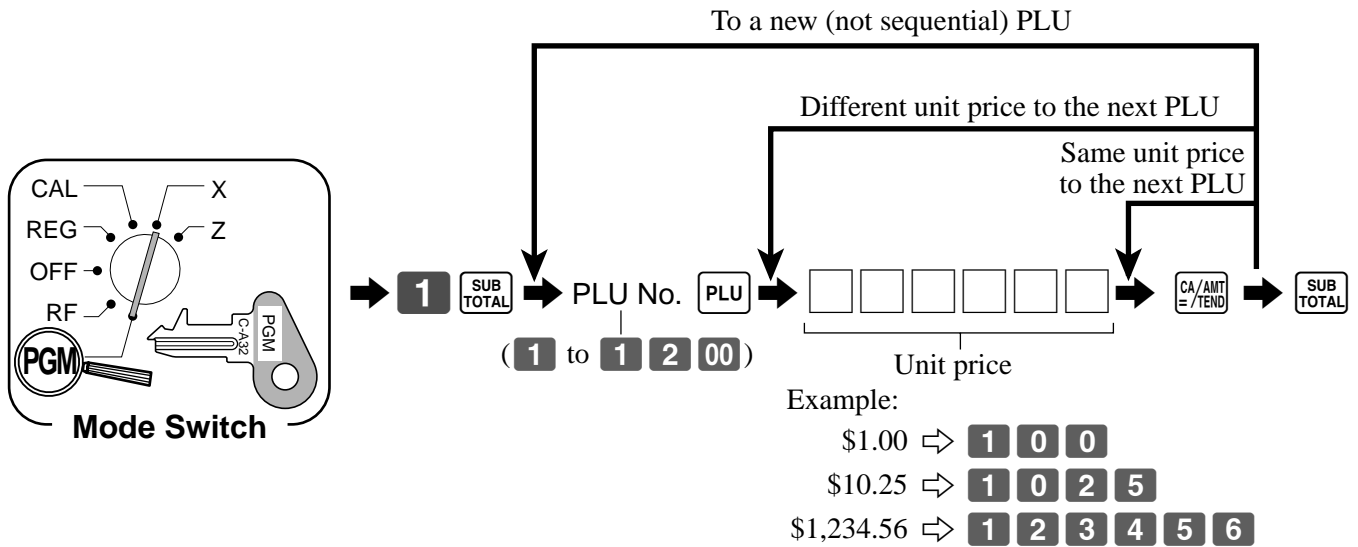

To program tax calculation status for each PLU

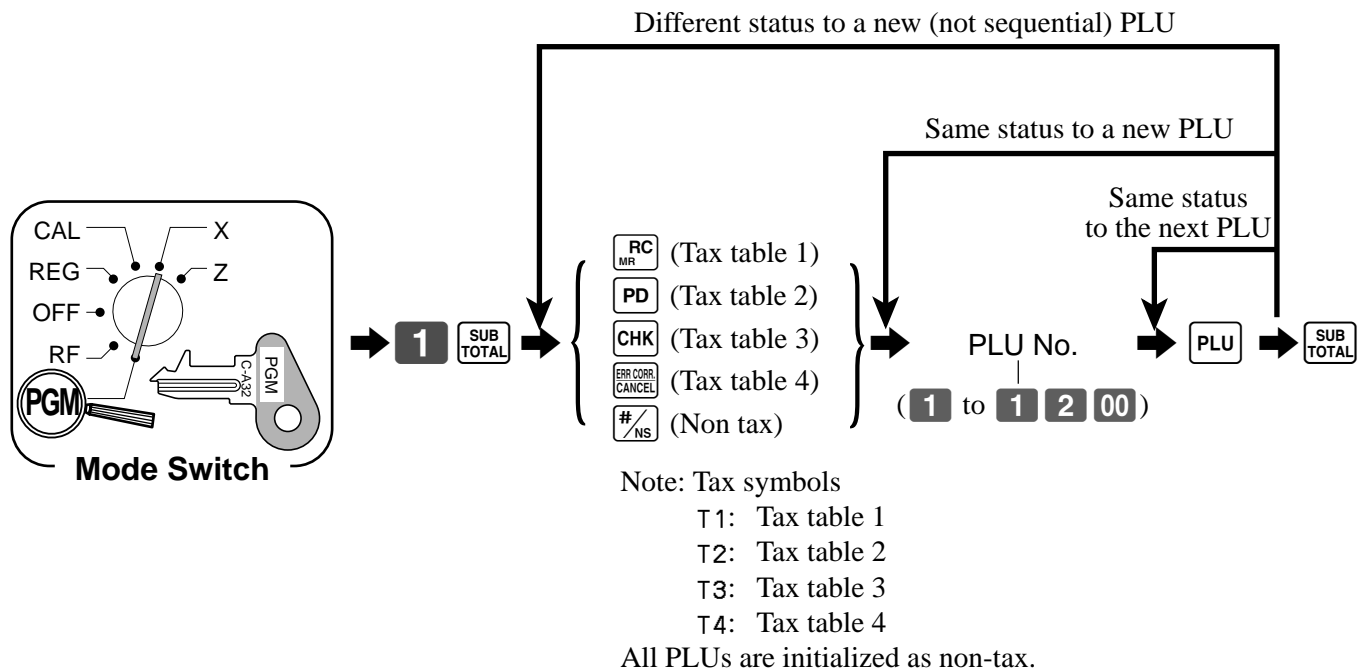

Basic Operations and Setups

Registering PLUs

The following examples show how you can use PLUs in various types of registrations.

Registering by subdepartment, see the "Convenient Operations and Setups" on page 66.

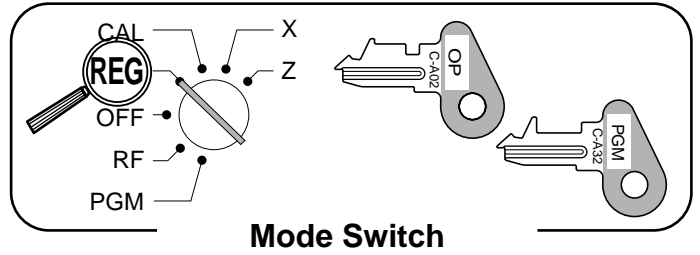

PLU single item sale

OPERATION

RECEIPT

Item	Unit price	(\$2.50)
	Quantity	1
	PLU	14
Payment	Cash	\$3.00

(): Preset value

1 4
PLU code

PLU

SUB TOTAL

3 00 CA/AMT =/TEND

REG	15-03-2002	09:10	
CLERK	01		000008
PLU0014			.2.50
TOTAL			.2.50
CASH			.3.00
CHANGE			.0.50

PLU descriptor/
unit price

PLU repeat

OPERATION

RECEIPT

Item	Unit price	(\$2.50)
	Quantity	3
	PLU	14
Payment	Cash	\$10.00

(): Preset value

1 4 **PLU**

PLU

PLU

SUB TOTAL

1 0 00 CA/AMT =/TEND

REG	15-03-2002	09:15	
CLERK	01		000009
PLU0014			.2.50
PLU0014			.2.50
PLU0014			.2.50
TOTAL			.7.50
CASH			.10.00
CHANGE			.2.50

PLU multiplication

OPERATION

RECEIPT

Item	Unit price	(\$1.20)
	Quantity	15
	PLU	2
Payment	Cash	\$20.00

(): Preset value

1 5 **X DATE TIME**
Quantity
(4-digit integer/2-digit decimal)

2 **PLU**

SUB TOTAL

2 0 00 CA/AMT =/TEND

REG	15-03-2002	09:20	
CLERK	01		000010
	15	X	@1.20
PLU0002			.18.00
TOTAL			.18.00
CASH			.20.00
CHANGE			.2.00

Preparing and using flat-PLUs

This section describes how to prepare and use flat-PLUs.

Programming flat-PLUs

To program a unit price for each flat-PLU

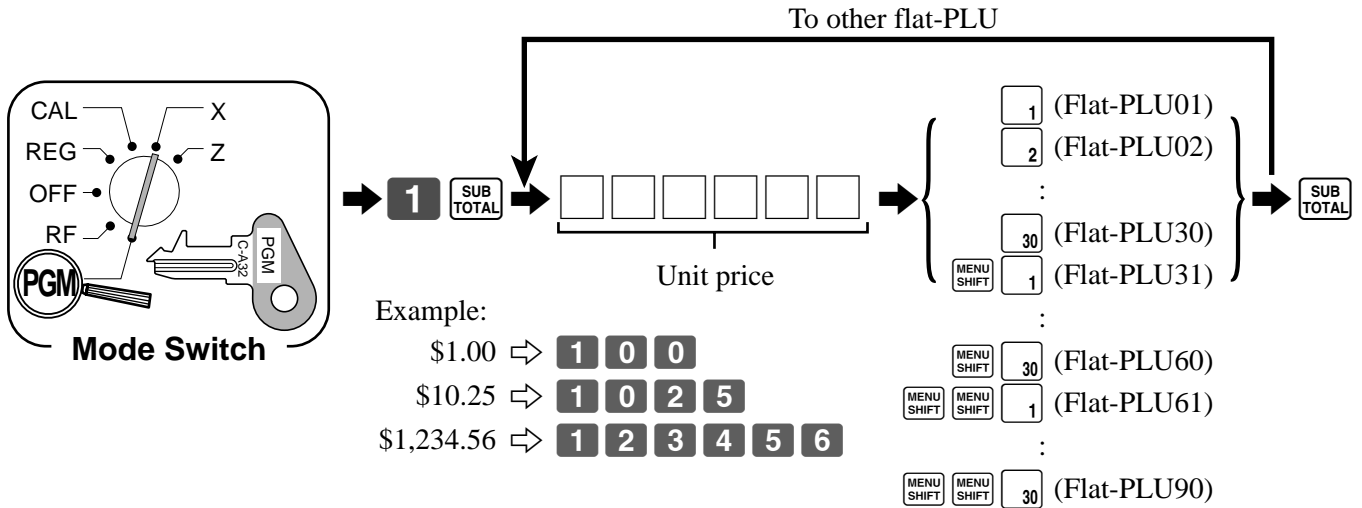

To program tax calculation status for each flat-PLU

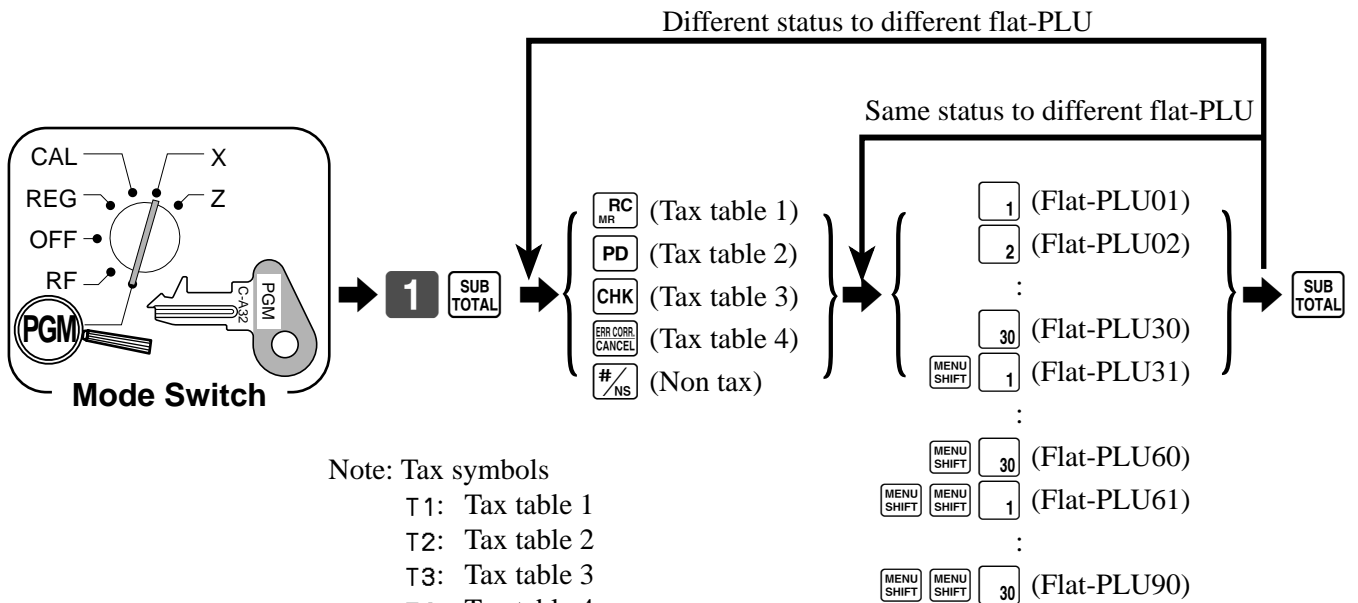

All flat-PLUs are initialized as non-tax.

Basic Operations and Setups

Registering flat-PLUs

The following examples show how you can use flat-PLUs in various types of registrations.

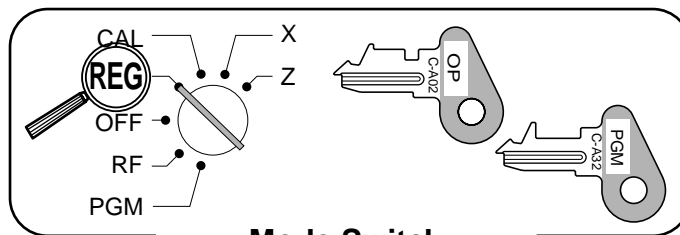

Mode Switch

Flat-PLU registration with manual price and preset price

OPERATION

Item 1	Unit price	\$2.50
	Quantity	2
	Flat-PLU	1
Item 2	Unit price	(\$2.00)
	Quantity	1
	Flat-PLU	2
Payment	Cash	\$10.00

(): Preset value

2 5 0 [1] [1]
 Repeat registration
 [2] [SUB TOTAL]
 1 0 00 [CA/AMT =/TEND]

RECEIPT

REG	15-03-2002 09:25	
CLERK	01	000011
PLU0001	.2.50	PLU No./unit price
PLU0001	.2.50	Repeat
PLU0002	.2.00	
TOTAL	7.00	
CASH	10.00	
CHANGE	3.00	

Flat-PLU registration using menu shift

OPERATION

Item 1	Unit price	(\$2.50)
	Quantity	2
	Flat-PLU	31
Item 2	Unit price	(\$1.50)
	Quantity	5
	Flat-PLU	90
Payment	Cash	\$10.00

(): Preset value

[MENU SHIFT]
 Press [MENU SHIFT] once to designate flat-PLU 31 - 60.
 [1] [X/DATE TIME]
 [5] [MENU SHIFT] [MENU SHIFT]
 Press [MENU SHIFT] twice to designate flat-PLU 61 - 90.
 [30] [SUB TOTAL]
 1 0 00 [CA/AMT =/TEND]

RECEIPT

REG	15-03-2002 09:30	
CLERK	01	000012
PLU0031	.2.50	
5 X	@1.50	
PLU0090	.7.50	
TOTAL	10.00	
CASH	10.00	
CHANGE	0.00	

Preparing and using discounts

This section describes how to prepare and register discount.

Programming discounts

You can use the [%] key to register discounts (percentage decreases). The more detailed informations about the discount (and premium) are described in the “Registering discounts and premiums” section in the “Convenient Operations and setups” on page 68.

To program a rate to the [%] key

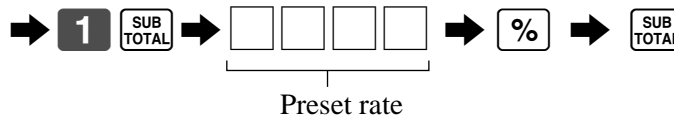
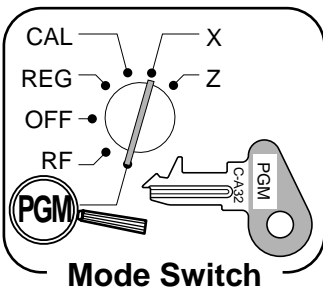

Example:

10% ⇨ 1 0

5.5% ⇨ 5 . 5

12.34% ⇨ 1 2 . 3 4

To program tax status to the [%] key

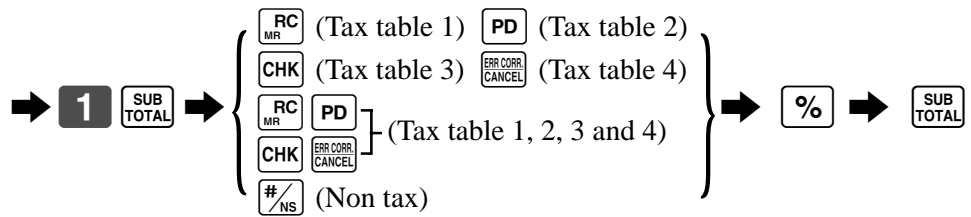
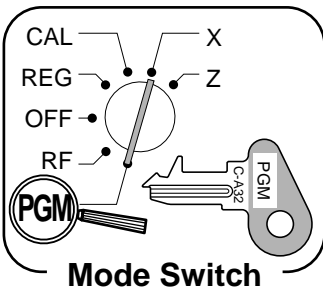

Note: Tax symbols

T1: Tax table 1

T2: Tax table 2

T3: Tax table 3

T4: Tax table 4

*: Tax table 1, 2, 3 and 4

[%] is initialized as non-tax.

Basic Operations and Setups

Registering discounts

The following example shows how you can use the key in various types of registration.

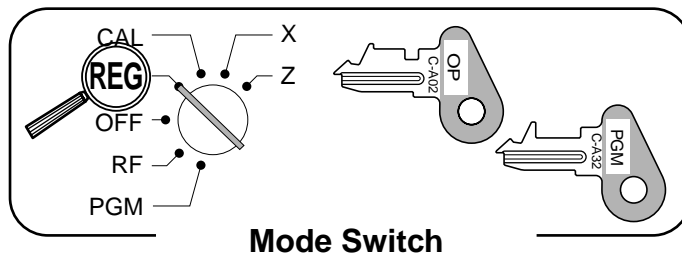

Mode Switch

Discount for items and subtotals

OPERATION

RECEIPT

Item 1	Unit price	\$5.00
	Quantity	1
	Dept.	1
Item 2	Unit price	(\$10.00)
	Quantity	1
	PLU	16
Discount	Rate	(5%)
Subtotal	Rate	3.5%
Discount		
Payment	Cash	\$15.00

(): Preset value

5 00 + 1
1 6 PLU
%

Applies the preset discount rate to the last item registered.

SUB TOTAL

3 . 5 %

The input value takes priority of the preset value.

SUB TOTAL

1 5 00 CA/AMT =/TEND

```

REG 15-03-2002 09:35
CLERK 01 000013

DEPT01 .5.00
PLU0016 .10.00
5%
%- .0.50
ST .14.50
3.5%
%- .0.51
TOTAL .13.99
CASH .15.00
CHANGE .1.01
    
```

- You can manually input rates up to 4 digits long (0.01% to 99.99%).



Taxable status of the key

- Whenever you perform a discount operation on the last item registered, the tax calculation for discount amount is performed in accordance with the tax status programmed for that item.
- Whenever you perform a discount operation on a subtotal amount, the tax calculation for the subtotal amount is performed in accordance with the tax status programmed for the key.

Preparing and using reductions

This section describes how to prepare and register reductions.

Programming for reductions

You can use the  key to reduce single item or subtotal amounts. The following procedure lets you program the tax calculation method for the  key.

To program tax calculation status

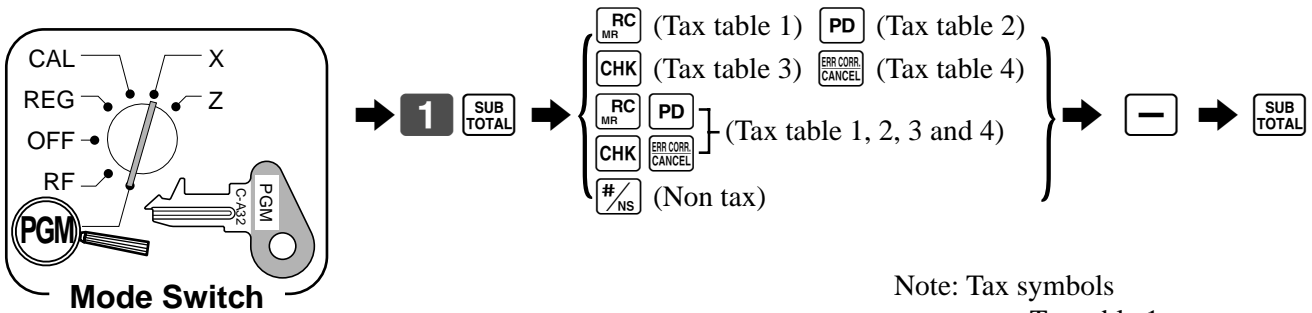

Note: Tax symbols

T1: Tax table 1

T2: Tax table 2

T3: Tax table 3

T4: Tax table 4

*: Tax table 1, 2, 3 and 4

 is initialized as non-tax.

Taxable status of the key

The tax calculation for the reduction amount is performed in accordance with the tax status programmed for the  key, regardless of whether the reduction is performed on the last item registered or a subtotal amount.

To program preset reduction amount

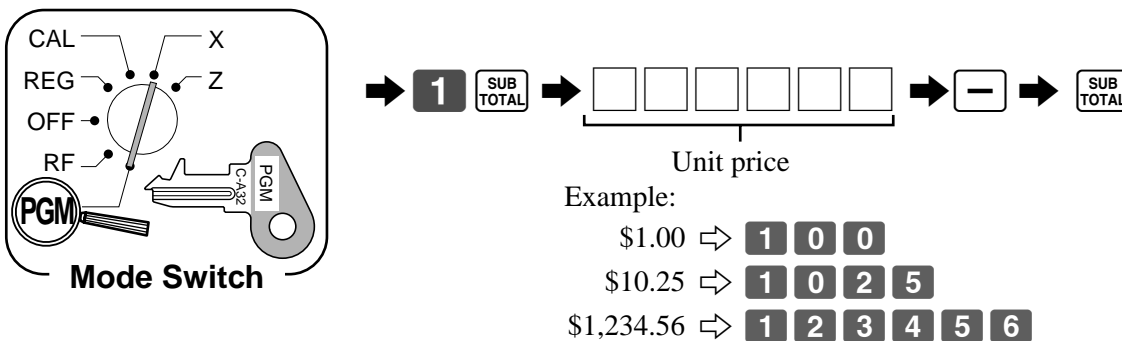

Basic Operations and Setups

Registering reductions

The following examples show how you can use the  key in various types of registration.

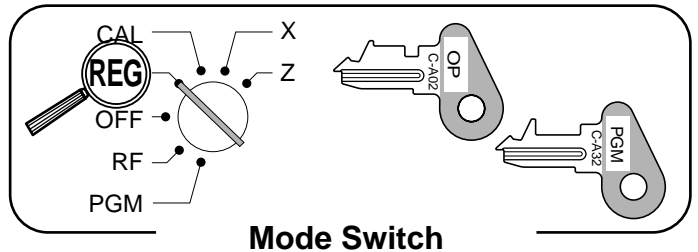







Reduction for items

OPERATION

RECEIPT

Item 1	Unit price	\$5.00
	Quantity	1
	Dept.	1
Reduction	Amount	\$0.25
Item 2	Unit price	(\$6.00)
	Quantity	1
	PLU	45
Reduction	Amount	(\$0.50)
Payment	Cash	\$11.00

(): Preset value



 Reduces the last amount registered by the value input.





```

REG 15-03-2002 09:40
CLERK 01 000014

DEPT01 .5.00
- .0.25
PLU0045 .6.00
- .0.50
TOTAL .10.25
CASH .11.00
CHANGE .0.75
    
```







- You can manually input reduction values up to 7 digits long.
- The amount you input for the reduction is neither subtracted from the department nor PLU totalizer.

Reduction for subtotal

OPERATION

RECEIPT

Item 1	Unit price	\$3.00
	Quantity	1
	Dept.	1
Item 2	Unit price	\$4.00
	Quantity	1
	Dept.	2
Subtotal	Amount	\$7.00
Reduction	Amount	\$0.75
Payment	Cash	\$7.00





 Reduces the subtotal by the value input here.



```

REG 15-03-2002 10:40
CLERK 01 000015

DEPT01 .3.00
DEPT02 .4.00
- .0.75
TOTAL .6.25
CASH .7.00
CHANGE .0.75
    
```

Registering credit and check payments

The following examples show how to register credits and payments by check.

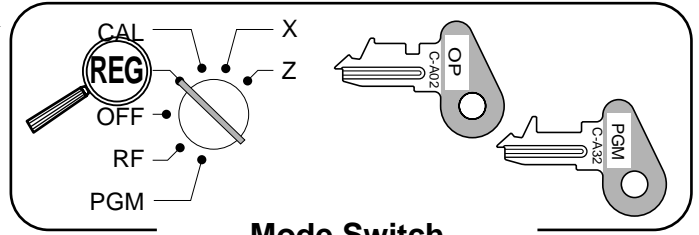

Check

OPERATION

Item	Unit price	\$10.00
	Quantity	1
	Dept.	1
Payment	Check	\$10.00

1 0 00 + 1
SUB TOTAL
1 0 00 CHK

RECEIPT

```
REG 15-03-2002 10:50
CLERK 01 000018
DEPT01 .10.00
TOTAL .10.00
CHECK .10.00
CHANGE .00.00
```

Credit

OPERATION

Item	Unit price	\$15.00
	Quantity	1
	Dept.	4
Reference	Number	0123
Payment	Credit	\$15.00

1 5 00 ÷ 4
SUB TOTAL
0 1 2 3 #/NS
CR

RECEIPT

```
REG 15-03-2002 10:55
CLERK 01 000019
DEPT04 .15.00
#/NS 0123 Reference No.
CREDIT .15.00
```

Mixed tender (cash, credit and check)

OPERATION

Item	Unit price	\$55.00
	Quantity	1
	Dept.	4
Payment	Check	\$30.00
	Cash	\$5.00
	Credit	\$20.00

5 5 00 ÷ 4
SUB TOTAL
3 0 00 CHK
5 00 CA/AMT =/TEND
CR

RECEIPT

```
REG 15-03-2002 11:00
CLERK 01 000020
DEPT04 .55.00
TOTAL .55.00
CHECK .30.00
CASH .5.00
CREDIT .20.00
```

Registering returned goods in the REG mode

The following example shows how to use the **RF** key in the REG mode to register goods returned by customers.

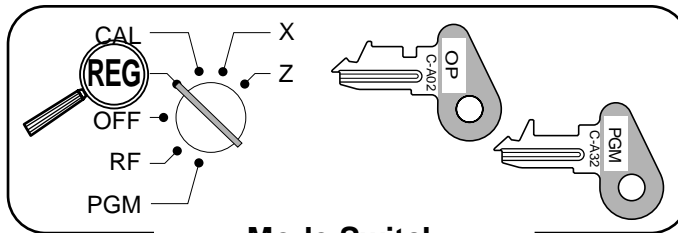

Mode Switch

OPERATION

Item 1	Unit price	\$2.35
	Quantity	1
	Dept.	1
Item 2	Unit price	\$2.00
	Quantity	1
	Dept.	2
Item 3	Unit price	(\$1.20)
	Quantity	1
	PLU	1
Item 1 Returned	Unit price	\$2.35
	Quantity	1
	Dept.	1
Item 3 Returned	Unit price	(\$1.20)
	Quantity	1
	PLU	1
Payment	Cash	\$2.00

(): Preset value

2 3 5 + 1

2 00 - 2

1 PLU

RF

2 3 5 + 1

Pressing **RF** specifies that the next item registered is a return.

RF

1 PLU

You have to press **RF** before registering each returned item.

**SUB
TOTAL**

**CA/AMT
=/TEND**

RECEIPT

```

REG 15-03-2002 11:05
CLERK 01 000021

DEPT01 .2.35
DEPT02 .2.00
PLU0001 .1.20
REFUND .....
DEPT01 -2.35
REFUND .....
PLU0001 -1.20
CASH .2.00
    
```

Registering returned goods in the RF mode

The following examples show how to use the RF mode to register goods returned by customers.

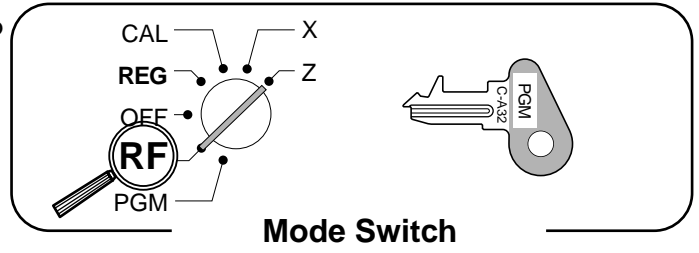

Normal refund transaction

OPERATION

Item 1 Returned	Unit price	\$1.50
	Quantity	2
	Dept.	1
Item 2 Returned	Unit price	(\$1.20)
	Quantity	6
	PLU	2
Payment	Cash	\$10.20

(): Preset value

1 5 0 + 1
+ 1
6 X/DATE TIME
2 PLU
SUB TOTAL
CA/AMT = /TEND

RECEIPT

RF mode symbol

RF	15-03-2002	11:10
CLERK 01		000022
DEPT01		. 1.50
DEPT01		. 1.50
PLU0002	6 X @1.20	. 7.20
CASH		. 10.20

Reduction of amounts paid on refund

OPERATION

Item 1 Returned	Unit price	\$4.00
	Quantity	1
	Dept.	3
Reduction	Amount	\$0.15
Item 2 Returned	Unit price	(\$1.20)
	Quantity	1
	PLU	2
Discount	Rate	(5%)
Payment	Cash	\$4.99

(): Preset value

4 00 x 3
1 5 -
2 PLU
%
SUB TOTAL
CA/AMT = /TEND

RECEIPT

RF mode symbol

RF	15-03-2002	11:15
CLERK 01		000023
DEPT03		. 4.00
-		-0.15
PLU0002		. 1.20
%-	5%	-0.06
CASH		. 4.99

Important!

To avoid miss registrations in the RF mode, return the mode switch to the former position immediately.

Registering money received on account

The following example shows how to register money received on account. This registration must be performed out of a sale.

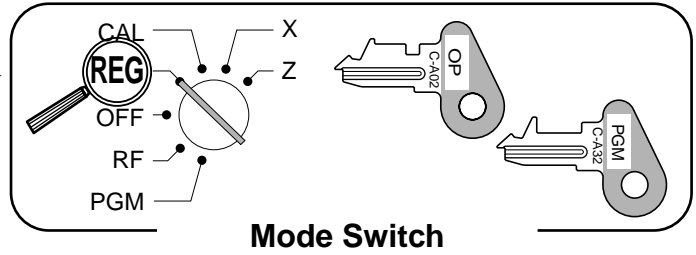

OPERATION

Received amount	\$700.00
-----------------	----------

7 00 00 **RC**
MR

Amount can be up to 8 digits.

RECEIPT

REG	15-03-2002	11:20
CLERK	01	000024
RC		·700.00

Registering money paid out

The following example shows how to register money paid out from the register. This registration must be performed out of a sale.

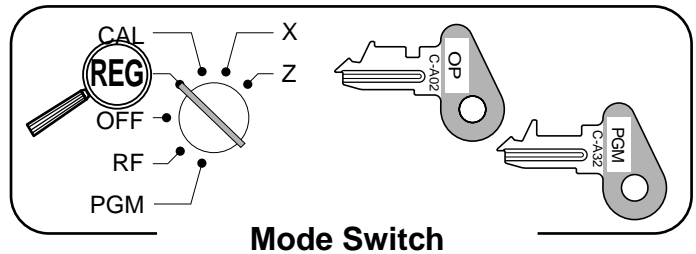

OPERATION

Paid out amount	\$1.50
-----------------	--------

1 5 0 **PD**

Amount can be up to 8 digits.

RECEIPT

REG	15-03-2002	11:30
CLERK	01	000025
PD		·1.50

Making corrections in a registration

There are three techniques you can use to make corrections in a registration.

- To correct an item that you input but not yet registered.
- To correct the last item you input and registered.
- To cancel all items in a transaction.

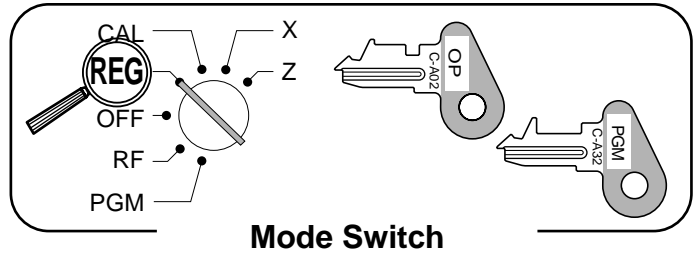

Mode Switch

To correct an item you input but not yet registered

OPERATION

RECEIPT

<p>2 00</p> <p>1 00 C</p> <p>1 2 + 1</p> <p>1 1 X/DATE TIME</p> <p>2 00 C</p> <p>2 - 2</p> <p>2</p> <p>3 C</p> <p>1 5 PLU</p> <p>6 00</p> <p>1 5 C</p> <p>1 5 PLU</p> <p>Enter subdepartment No. again.</p> <p>1 0 00 ADD/PRICE</p> <p>1 0 00 SUB TOTAL</p> <p>1 5 00 C</p> <p>1 5 00 CA/AMT = /TEND</p> <p>CR</p>	<p>Correction of unit price</p> <p>Correction of quantity</p> <p>Correction of PLU No.</p> <p>Correction of subdepartment unit price (See page 66 for registering.)</p> <p>Correction of partial tender amount</p>
---	--

REG	15-03-2002	11:35	
CLERK	01		000026
DEPT01			.1.00
11	X	@2.00	
DEPT02			.22.00
PLU0003			.1.30
PLU0015			.10.00
TOTAL			.34.30
CASH			.15.00
CREDIT			.19.30

Basic Operations and Setups

To correct the last item you input and registered

OPERATION

RECEIPT

1 00 + 1		
2 00 - 2		
	- 2	Clearance
	ERR CORR CANCEL	
2 PLU		Correction of PLU No.
	ERR CORR CANCEL	
5 PLU		
1 5 PLU		Correction of sub- department unit price
6 00 ADD/ PRICE		
	ERR CORR CANCEL	
1 5 PLU		
1 0 00 ADD/ PRICE		
8 X DATE TIME		Correction of quantity
4 00 ÷ 4		
	ERR CORR CANCEL	
6 X DATE TIME		
4 00 ÷ 4		
	SUB TOTAL	Correction of discount
5 0 %		
	ERR CORR CANCEL	
	SUB TOTAL	
5 %		
RF 2 00 - 2		Correction of refund item
	ERR CORR CANCEL	
RF 2 2 0 - 2		
	SUB TOTAL	
2 0 00 CA/AMT =/TEND		Correction of partial tender
	ERR CORR CANCEL	
1 5 00 CA/AMT =/TEND		
	CR	

REG	15-03-2002	11:40
CLERK	01	000027
DEPT01		.1.00
DEPT02		.2.00
DEPT02		.2.00
ERR CORR		-2.00
PLU0002		.1.20
ERR CORR		-1.20
PLU0005		.1.50
PLU0015		.6.00
ERR CORR		-6.00
PLU0015		.10.00
8 X	@4.00	
DEPT04		.32.00
ERR CORR		-32.00
6 X	@4.00	
DEPT04		.24.00
ST		.38.50
50%		
%-		-19.25
ERR CORR		.19.25
ST		.38.50
5%		
%-		-1.93
REFUND	
DEPT02		-2.00
ERR CORR		.2.00
REFUND	
DEPT02		-2.20
TOTAL		.34.37
CASH		.20.00
ERR CORR		-20.00
CASH		.15.00
CREDIT		.19.37

To cancel all items in a transaction

OPERATION	RECEIPT
<div style="display: flex; flex-direction: column; align-items: center;"> <div style="display: flex; gap: 5px;"> <div style="border: 1px solid black; padding: 2px;">1</div> <div style="border: 1px solid black; padding: 2px;">00</div> <div style="border: 1px solid black; padding: 2px;">+ 1</div> </div> <div style="display: flex; gap: 5px;"> <div style="border: 1px solid black; padding: 2px;">2</div> <div style="border: 1px solid black; padding: 2px;">00</div> <div style="border: 1px solid black; padding: 2px;">- 2</div> </div> <div style="display: flex; gap: 5px;"> <div style="border: 1px solid black; padding: 2px;">3</div> <div style="border: 1px solid black; padding: 2px;">00</div> <div style="border: 1px solid black; padding: 2px;">× 3</div> </div> <div style="display: flex; gap: 5px;"> <div style="border: 1px solid black; padding: 2px;">4</div> <div style="border: 1px solid black; padding: 2px;">00</div> <div style="border: 1px solid black; padding: 2px;">± 4</div> </div> <div style="border: 1px solid black; padding: 2px; margin-top: 5px;">SUB TOTAL</div> </div>	<div style="border: 1px solid black; padding: 5px; width: fit-content; margin: auto;"> <p>REG 15-03-2002 11:45 CLERK 01 000028</p> <p>DEPT01 · 1.00 DEPT02 · 2.00 DEPT03 · 3.00 DEPT04 · 4.00 CANCEL TTL</p> </div>
<p>Pressing key is necessary to cancel the transaction.</p> <div style="border: 1px solid black; padding: 2px; margin: 5px auto; width: fit-content;">ERR CORR. CANCEL</div>	

Important!

- Note that the number of items included in the transaction to be cancelled is limited (24 ~ 40 items), depending on the complexity of the transaction. If you try to cancel a transaction that exceeds the limit, an error occurs.
In case of occurrence of this error, register these items in the RF mode.
- You can program the cash register that this cancel operation is not allowed.

No sale registration

You can use the following procedure to open the drawer without registering a sale. This operation must be performed out of a sale.

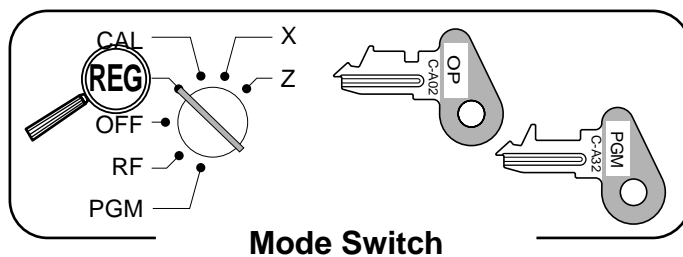

OPERATION	RECEIPT
<div style="border: 1px solid black; padding: 5px; width: fit-content; margin: auto;"># / NS</div>	<div style="border: 1px solid black; padding: 5px; width: fit-content; margin: auto;"> <p>REG 15-03-2002 11:50 CLERK 01 000029</p> <p># / NS</p> </div>

Printing the daily sales reset report

This report shows daily sales totals.

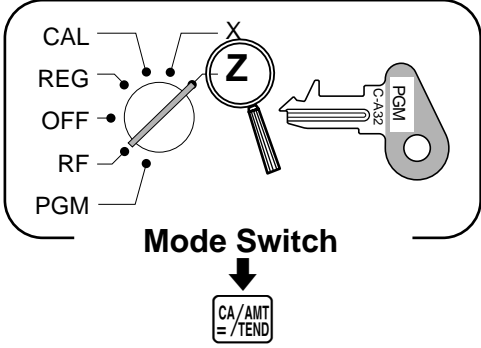
OPERATION	REPORT																																																																																																																																																																																																																																																				
 <p>Mode Switch</p> <p>CA/AMT =/TEND</p>	<table border="0"> <tr> <td>Z</td> <td>15-03-2002</td> <td>12:00</td> <td>Reset mode/date/time</td> </tr> <tr> <td>CLERK 01</td> <td></td> <td>000030</td> <td>Clerk/consecutive No.</td> </tr> <tr> <td>0000</td> <td>DAILY</td> <td>Z 0001</td> <td>Report code/report title/reset symbol/ reset counter</td> </tr> <tr> <td>DEPT01</td> <td>QT</td> <td>15</td> <td>Department No./No. of items^{*1}</td> </tr> <tr> <td></td> <td></td> <td>·339.50</td> <td>Department amount^{*1}</td> </tr> <tr> <td>DEPT02</td> <td>QT</td> <td>19</td> <td></td> </tr> <tr> <td></td> <td></td> <td>·62.70</td> <td></td> </tr> <tr> <td>DEPT03</td> <td>QT</td> <td>31</td> <td></td> </tr> <tr> <td></td> <td></td> <td>·139.10</td> <td></td> </tr> <tr> <td>DEPT04</td> <td>QT</td> <td>23</td> <td></td> </tr> <tr> <td></td> <td></td> <td>·332.67</td> <td></td> </tr> <tr> <td>NON-LINK DPT</td> <td>QT</td> <td>10</td> <td>Non-link department No. of items</td> </tr> <tr> <td></td> <td></td> <td>·94.90</td> <td>Non-link department amount</td> </tr> <tr> <td colspan="4">-----</td> </tr> <tr> <td>GROSS TOTAL</td> <td>QT</td> <td>253</td> <td>Gross No. of items</td> </tr> <tr> <td></td> <td></td> <td>·1146.90</td> <td>Gross sales amount</td> </tr> <tr> <td>NET TOTAL</td> <td>No</td> <td>100</td> <td>No. of customers</td> </tr> <tr> <td></td> <td></td> <td>·1217.63</td> <td>Net sales amount</td> </tr> <tr> <td>CASH-INDW</td> <td></td> <td>·903.06</td> <td>Cash in drawer amount</td> </tr> <tr> <td>CHECK-INDW</td> <td></td> <td>·183.60</td> <td>Check in drawer amount</td> </tr> <tr> <td>CREDIT-INDW</td> <td></td> <td>·197.17</td> <td>Credit in drawer amount</td> </tr> <tr> <td>TAX-AMT 1</td> <td></td> <td>·732.56</td> <td>Taxable amount 1^{*2}</td> </tr> <tr> <td>TAX 1</td> <td></td> <td>·43.96</td> <td>Tax amount 1^{*2}</td> </tr> <tr> <td>TAX-AMT 2</td> <td></td> <td>·409.72</td> <td>Taxable amount 2^{*2}</td> </tr> <tr> <td>TAX 2</td> <td></td> <td>·21.55</td> <td>Tax amount 2^{*2}</td> </tr> <tr> <td>TAX-AMT 3</td> <td></td> <td>·272.50</td> <td>Taxable amount 3^{*2}</td> </tr> <tr> <td>TAX 3</td> <td></td> <td>·8.18</td> <td>Tax amount 3^{*2}</td> </tr> <tr> <td>ROUNDING AMT</td> <td></td> <td>·4.75</td> <td>Rounding amount (Australia only)</td> </tr> <tr> <td>CANCEL TTL</td> <td>No</td> <td>2</td> <td>Cancellation count</td> </tr> <tr> <td></td> <td></td> <td>·108.52</td> <td>Cancellation amount</td> </tr> <tr> <td>RF-MODE TTL</td> <td>No</td> <td>2</td> <td>Refund mode operation count^{*3}</td> </tr> <tr> <td></td> <td></td> <td>·3.74</td> <td>Refund mode operation amount^{*3}</td> </tr> <tr> <td colspan="4">-----</td> </tr> <tr> <td>CASH</td> <td>No</td> <td>81</td> <td>Cash sales count</td> </tr> <tr> <td></td> <td></td> <td>·836.86</td> <td>Cash sales amount</td> </tr> <tr> <td>CHECK</td> <td>No</td> <td>10</td> <td>Check sales count</td> </tr> <tr> <td></td> <td></td> <td>·197.17</td> <td>Check sales amount</td> </tr> <tr> <td>CREDIT</td> <td>No</td> <td>9</td> <td>Credit sales count</td> </tr> <tr> <td></td> <td></td> <td>·183.60</td> <td>Credit sales amount</td> </tr> <tr> <td>RC</td> <td>No</td> <td>2</td> <td>Received on Account count</td> </tr> <tr> <td></td> <td></td> <td>·78.00</td> <td>Received on Account amount</td> </tr> <tr> <td>PD</td> <td>No</td> <td>1</td> <td>Paid out count</td> </tr> <tr> <td></td> <td></td> <td>·6.80</td> <td>Paid out amount</td> </tr> <tr> <td>-</td> <td>No</td> <td>8</td> <td>Subtraction count</td> </tr> <tr> <td></td> <td></td> <td>·3.00</td> <td>Subtraction amount</td> </tr> <tr> <td>%-</td> <td>No</td> <td>10</td> <td>Discount count</td> </tr> <tr> <td></td> <td></td> <td>·4.62</td> <td>Discount amount</td> </tr> <tr> <td>REFUND</td> <td>No</td> <td>7</td> <td>Refund key count^{*3}</td> </tr> <tr> <td></td> <td></td> <td>·27.79</td> <td>Refund key amount^{*3}</td> </tr> <tr> <td>ERR CORR</td> <td>No</td> <td>10</td> <td>Error correction count</td> </tr> <tr> <td></td> <td></td> <td>·12.76</td> <td>Error correction amount</td> </tr> <tr> <td>#/NS</td> <td>No</td> <td>5</td> <td>No sale count</td> </tr> <tr> <td colspan="4">-----</td> </tr> <tr> <td>CLERK 01</td> <td>No</td> <td>12</td> <td>Clerk 1/clerk 1 sales count</td> </tr> <tr> <td></td> <td></td> <td>·127.63</td> <td>Clerk 1 sales amount</td> </tr> <tr> <td>CLERK 02</td> <td>No</td> <td>6</td> <td></td> </tr> <tr> <td></td> <td></td> <td>·113.90</td> <td></td> </tr> <tr> <td>CLERK 20</td> <td>No</td> <td>2</td> <td></td> </tr> <tr> <td></td> <td></td> <td>·113.90</td> <td></td> </tr> <tr> <td colspan="4">-----</td> </tr> <tr> <td>GRND TTL</td> <td>·000000</td> <td>1217.63</td> <td>Non-resettable grand-sales total^{*3}</td> </tr> </table>	Z	15-03-2002	12:00	Reset mode/date/time	CLERK 01		000030	Clerk/consecutive No.	0000	DAILY	Z 0001	Report code/report title/reset symbol/ reset counter	DEPT01	QT	15	Department No./No. of items ^{*1}			·339.50	Department amount ^{*1}	DEPT02	QT	19				·62.70		DEPT03	QT	31				·139.10		DEPT04	QT	23				·332.67		NON-LINK DPT	QT	10	Non-link department No. of items			·94.90	Non-link department amount	-----				GROSS TOTAL	QT	253	Gross No. of items			·1146.90	Gross sales amount	NET TOTAL	No	100	No. of customers			·1217.63	Net sales amount	CASH-INDW		·903.06	Cash in drawer amount	CHECK-INDW		·183.60	Check in drawer amount	CREDIT-INDW		·197.17	Credit in drawer amount	TAX-AMT 1		·732.56	Taxable amount 1 ^{*2}	TAX 1		·43.96	Tax amount 1 ^{*2}	TAX-AMT 2		·409.72	Taxable amount 2 ^{*2}	TAX 2		·21.55	Tax amount 2 ^{*2}	TAX-AMT 3		·272.50	Taxable amount 3 ^{*2}	TAX 3		·8.18	Tax amount 3 ^{*2}	ROUNDING AMT		·4.75	Rounding amount (Australia only)	CANCEL TTL	No	2	Cancellation count			·108.52	Cancellation amount	RF-MODE TTL	No	2	Refund mode operation count ^{*3}			·3.74	Refund mode operation amount ^{*3}	-----				CASH	No	81	Cash sales count			·836.86	Cash sales amount	CHECK	No	10	Check sales count			·197.17	Check sales amount	CREDIT	No	9	Credit sales count			·183.60	Credit sales amount	RC	No	2	Received on Account count			·78.00	Received on Account amount	PD	No	1	Paid out count			·6.80	Paid out amount	-	No	8	Subtraction count			·3.00	Subtraction amount	%-	No	10	Discount count			·4.62	Discount amount	REFUND	No	7	Refund key count ^{*3}			·27.79	Refund key amount ^{*3}	ERR CORR	No	10	Error correction count			·12.76	Error correction amount	#/NS	No	5	No sale count	-----				CLERK 01	No	12	Clerk 1/clerk 1 sales count			·127.63	Clerk 1 sales amount	CLERK 02	No	6				·113.90		CLERK 20	No	2				·113.90		-----				GRND TTL	·000000	1217.63	Non-resettable grand-sales total ^{*3}
Z	15-03-2002	12:00	Reset mode/date/time																																																																																																																																																																																																																																																		
CLERK 01		000030	Clerk/consecutive No.																																																																																																																																																																																																																																																		
0000	DAILY	Z 0001	Report code/report title/reset symbol/ reset counter																																																																																																																																																																																																																																																		
DEPT01	QT	15	Department No./No. of items ^{*1}																																																																																																																																																																																																																																																		
		·339.50	Department amount ^{*1}																																																																																																																																																																																																																																																		
DEPT02	QT	19																																																																																																																																																																																																																																																			
		·62.70																																																																																																																																																																																																																																																			
DEPT03	QT	31																																																																																																																																																																																																																																																			
		·139.10																																																																																																																																																																																																																																																			
DEPT04	QT	23																																																																																																																																																																																																																																																			
		·332.67																																																																																																																																																																																																																																																			
NON-LINK DPT	QT	10	Non-link department No. of items																																																																																																																																																																																																																																																		
		·94.90	Non-link department amount																																																																																																																																																																																																																																																		

GROSS TOTAL	QT	253	Gross No. of items																																																																																																																																																																																																																																																		
		·1146.90	Gross sales amount																																																																																																																																																																																																																																																		
NET TOTAL	No	100	No. of customers																																																																																																																																																																																																																																																		
		·1217.63	Net sales amount																																																																																																																																																																																																																																																		
CASH-INDW		·903.06	Cash in drawer amount																																																																																																																																																																																																																																																		
CHECK-INDW		·183.60	Check in drawer amount																																																																																																																																																																																																																																																		
CREDIT-INDW		·197.17	Credit in drawer amount																																																																																																																																																																																																																																																		
TAX-AMT 1		·732.56	Taxable amount 1 ^{*2}																																																																																																																																																																																																																																																		
TAX 1		·43.96	Tax amount 1 ^{*2}																																																																																																																																																																																																																																																		
TAX-AMT 2		·409.72	Taxable amount 2 ^{*2}																																																																																																																																																																																																																																																		
TAX 2		·21.55	Tax amount 2 ^{*2}																																																																																																																																																																																																																																																		
TAX-AMT 3		·272.50	Taxable amount 3 ^{*2}																																																																																																																																																																																																																																																		
TAX 3		·8.18	Tax amount 3 ^{*2}																																																																																																																																																																																																																																																		
ROUNDING AMT		·4.75	Rounding amount (Australia only)																																																																																																																																																																																																																																																		
CANCEL TTL	No	2	Cancellation count																																																																																																																																																																																																																																																		
		·108.52	Cancellation amount																																																																																																																																																																																																																																																		
RF-MODE TTL	No	2	Refund mode operation count ^{*3}																																																																																																																																																																																																																																																		
		·3.74	Refund mode operation amount ^{*3}																																																																																																																																																																																																																																																		

CASH	No	81	Cash sales count																																																																																																																																																																																																																																																		
		·836.86	Cash sales amount																																																																																																																																																																																																																																																		
CHECK	No	10	Check sales count																																																																																																																																																																																																																																																		
		·197.17	Check sales amount																																																																																																																																																																																																																																																		
CREDIT	No	9	Credit sales count																																																																																																																																																																																																																																																		
		·183.60	Credit sales amount																																																																																																																																																																																																																																																		
RC	No	2	Received on Account count																																																																																																																																																																																																																																																		
		·78.00	Received on Account amount																																																																																																																																																																																																																																																		
PD	No	1	Paid out count																																																																																																																																																																																																																																																		
		·6.80	Paid out amount																																																																																																																																																																																																																																																		
-	No	8	Subtraction count																																																																																																																																																																																																																																																		
		·3.00	Subtraction amount																																																																																																																																																																																																																																																		
%-	No	10	Discount count																																																																																																																																																																																																																																																		
		·4.62	Discount amount																																																																																																																																																																																																																																																		
REFUND	No	7	Refund key count ^{*3}																																																																																																																																																																																																																																																		
		·27.79	Refund key amount ^{*3}																																																																																																																																																																																																																																																		
ERR CORR	No	10	Error correction count																																																																																																																																																																																																																																																		
		·12.76	Error correction amount																																																																																																																																																																																																																																																		
#/NS	No	5	No sale count																																																																																																																																																																																																																																																		

CLERK 01	No	12	Clerk 1/clerk 1 sales count																																																																																																																																																																																																																																																		
		·127.63	Clerk 1 sales amount																																																																																																																																																																																																																																																		
CLERK 02	No	6																																																																																																																																																																																																																																																			
		·113.90																																																																																																																																																																																																																																																			
CLERK 20	No	2																																																																																																																																																																																																																																																			
		·113.90																																																																																																																																																																																																																																																			

GRND TTL	·000000	1217.63	Non-resettable grand-sales total ^{*3}																																																																																																																																																																																																																																																		

*1 Zero totalled departments (the amount and item numbers are both zero) are not printed.

*2 Taxable amount and tax amount are printed only if the corresponding tax table is programmed.

*3 These items can be skipped by programming.

Convenient Operations and Setups

This section describes more sophisticated setups and operations that you can use to suit the needs of your retail environment.

Post-finalization receipt format, General printing control, Compulsory, Machine features

About post-finalization receipt

The post-finalization receipt lets you issue a receipt after finalization of the transaction. Note that all of the following conditions must be satisfied.

- The option “print receipts” is selected.
- The receipt issuance status must be OFF.
- The transaction must be finalized in the REG or RF mode using the , or key.

Post-finalization receipt example

You can program the cash register to print the transaction total only (below Total format) or full details (below Detailed format) on the post-finalization receipt. Note that if the transaction contains more than 45 lines (including receipt header), the cash register prints in a Total format regardless of your programming.

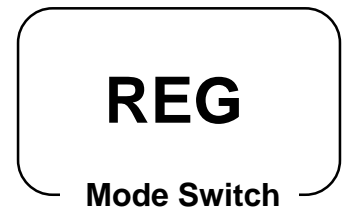

OPERATION RECEIPT

Item 1	Unit price	\$10.00
	Quantity	1
	Dept.	1
Item 2	Unit price	\$20.00
	Quantity	1
	Dept.	2
Payment	Cash	\$30.00

1

2

Receipt is not issued.

Post-finalization receipt is issued.

If “Automatic issue” is selected, no need to press key.

Total format

REG	15-03-2002	12:35
CLERK	01	000123
CASH		.30.00

Detailed format

REG	15-03-2002	12:35
CLERK	01	000123
DEPT01		.10.00
DEPT02		.20.00
TOTAL		.30.00
CASH		.30.00
CHANGE		.00.00

Important!

- You can issue only one post-finalization receipt per transaction.

Convenient Operations and Setups

Programming general printing control

Suppress printing of the subtotal line during tender operation.	a	No = 0 Yes = 1	a+b+c = <input type="text"/> D ₈
Print the total line even if no tender operation is made.	b	No = 0 Yes = 2	
Print tax total. (only for Australia)	c	No = 0 Yes = 4	
Print the current time.	a	Yes = 0 No = 1	a+b+c = <input type="text"/> D ₇
Skip the date on journal.	b	Yes = 0 No = 2	
Skip the consecutive number.	c	No = 0 Yes = 4	
Print receipt/Print journal.	a	Receipt = 0 Journal = 1	a+b+c = <input type="text"/> D ₆
Issue post receipt by Finalize key (automatic issue)/ Post receipt key (manual issue)	b	Manual = 0 Automatic = 2	
Detail format/Total format in the post receipt	c	Detail = 0 Total = 4	
Print taxable amount.	a	Yes = 0 No = 1	a+b+c = <input type="text"/> D ₅
Print tax symbols.	b	Yes = 0 No = 2	
Print number of item sold.	c	No = 0 Yes = 4	
Skip item lines on journal. (journal skip)	a	No = 0 Yes = 1	a+b+c = <input type="text"/> D ₄
Print subtotal when the key is pressed.	b	No = 0 Yes = 2	
Time system: 1 24 hour system, 2 12 hour system	c	1 = 0 2 = 4	
Digit separator symbol.	a	Comma = 0 Period = 1	a+b+c = <input type="text"/> D ₃
Decimal symbol.	b	Period = 0 Comma = 2	
Journal compressed print (print by half height characters)	c	Yes = 0 No = 4	
Print hyphens before finalizing a transaction.	a	No = 0 Yes = 1	a+b = <input type="text"/> D ₂
Print tax total on receipt and report.	b	No = 0 Yes = 2	
Print Australian GST MOF message.	a	No = 0 Yes = 1	a+b = <input type="text"/> D ₁
Print receipt by double height characters.	b	No = 0 Yes = 2	

PGM
Mode Switch

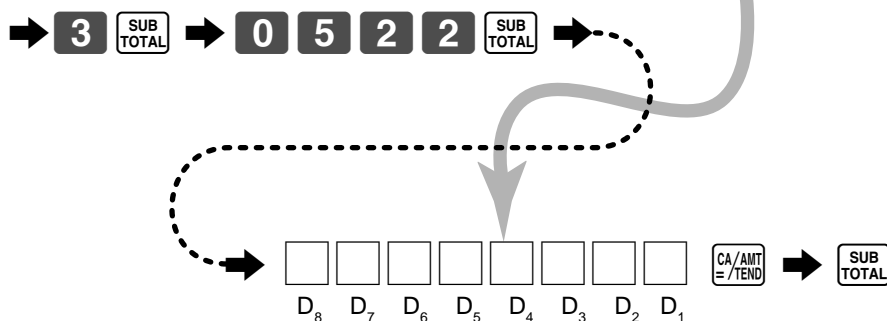

Programming compulsory and clerk control function

Force <input type="button" value="SUB TOTAL"/> operation before finalization.	a	No = 0 Yes = 2	a+b = <input type="text"/> D ₈
Force a money declaration before allowing a daily read/reset and financial read operation.	b	No = 0 Yes = 4	
Force to enter the number of customers		No = 0 Yes = 2	<input type="text"/> D ₇
Always "0"			<input type="text" value="0"/> D ₆
Maintain the menu shift status for the next flat-PLU registration. (If "No", press <input type="button" value="MENU SHIFT"/> each time.)	a	No = 0 Yes = 1	a+b+c = <input type="text"/> D ₅
Multiplication procedure: 1 Quantity × amount, 2 Amount × quantity	b	1 = 0 2 = 2	
Treat the numeric entries before pressing flat-PLU key as amount or quantity.	c	Amount = 0 Quantity = 4	
Clear the key buffer when a receipt is issued.	a	No = 0 Yes = 1	a+b+c = <input type="text"/> D ₄
Perform auto sign-off when a receipt/report is issued.	b	No = 0 Yes = 2	
Restriction (to 0, 5) on last amount digit of cash sales, received on account, paid out and money declaration (only for Australia)	c	No = 0 Yes = 4	
Display "seconds" during time display.		No = 0 Yes = 2	<input type="text"/> D ₃
Reset the consecutive number when the daily reset report is issued.	a	Yes = 0 No = 1	a+b = <input type="text"/> D ₂
Prohibit cancel operation.	b	No = 0 Yes = 2	
Always "0"			<input type="text" value="0"/> D ₁

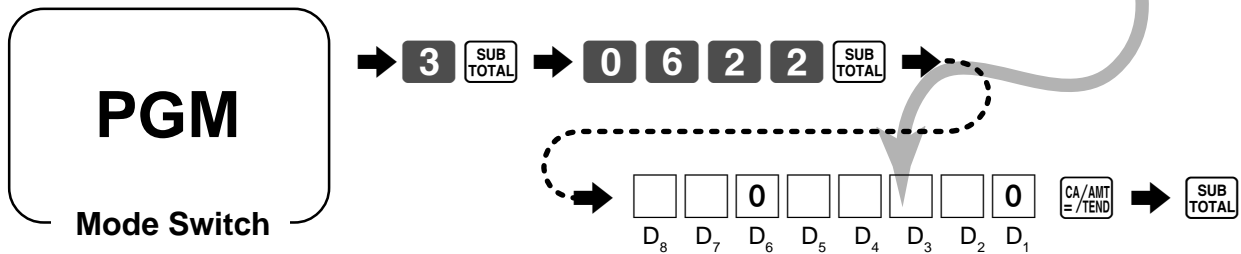

Convenient Operations and Setups

Programming read/reset report printing control

Recording method of electronic journal memory: 1 Superscribe old data , 2 Append to old data	a	1 = 0 2 = 1	a+b = <input type="text"/> D ₆
Print the first and the last consecutive number of the day (consecutive No. range) on the daily sales reset report.	b	No = 0 Yes = 4	
Skip zero total lines on department and transaction read/reset report.	a	Yes = 0 No = 1	a+b+c = <input type="text"/> D ₅
Skip zero total lines on PLU read/reset report.	b	Yes = 0 No = 2	
Skip zero total lines on hourly sales report.	c	Yes = 0 No = 4	
Print the sales ratio on read/reset report.	a	No = 0 Yes = 1	a+b = <input type="text"/> D ₄
Suppress printing of the non-resettable grand total on the daily reset report.	b	No = 0 Yes = 2	a+b = <input type="text"/> D ₃
Suppress printing of RF total and count (both RF mode and RF key) on the read/reset report.	a	No = 0 Yes = 1	
Print tax rate with tax totalizer.	b	No = 0 Yes = 2	0 0 D ₂ D ₁
Always "00"			

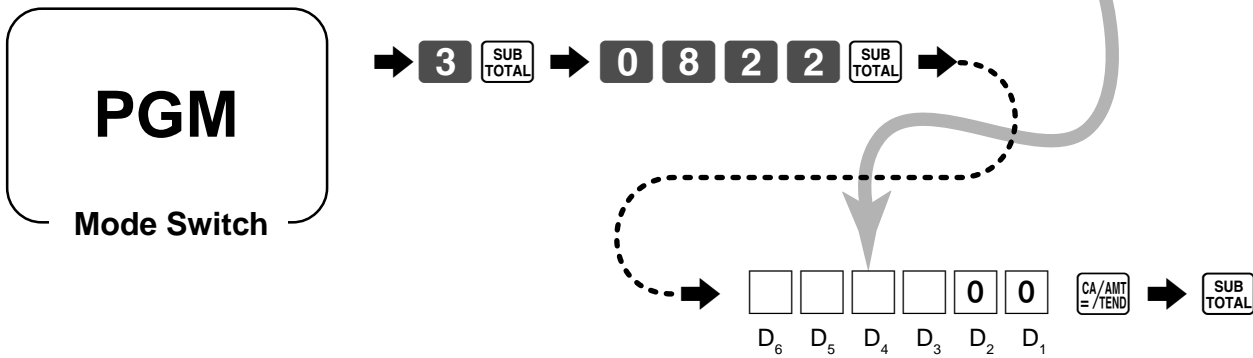

Setting a store/machine number

You can set a 4-digit machine number to identify your machine. The machine number is printed on receipts/journal for each transaction.

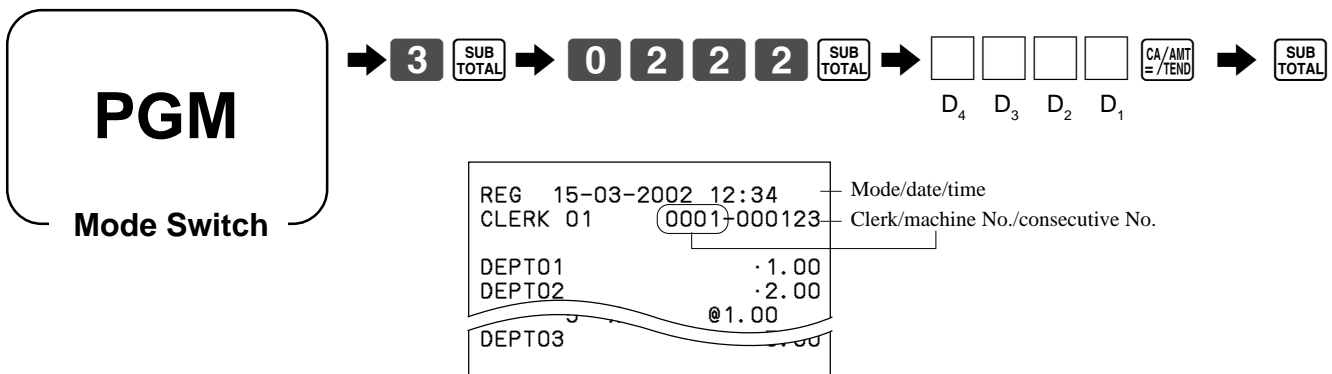

Programming to clerk

You can program up to 4-digit assigning number (clerk number) and trainee status of clerk (i.e. training cashier) and clerk commission rate for each clerk.

Programming clerk number

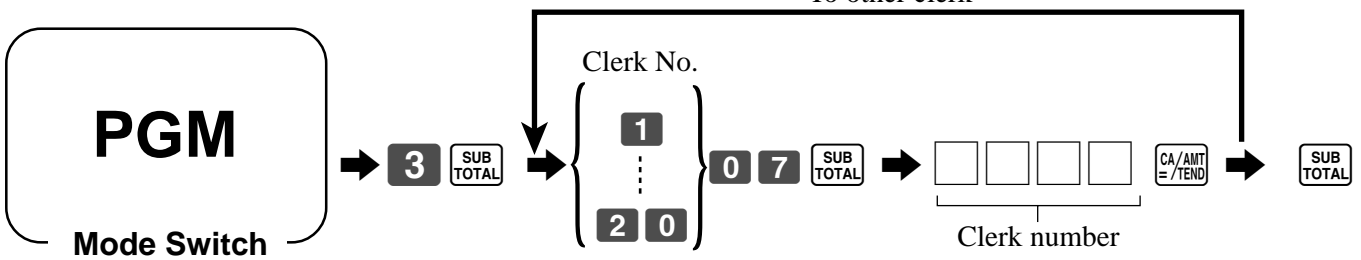

Programming trainee status of clerk

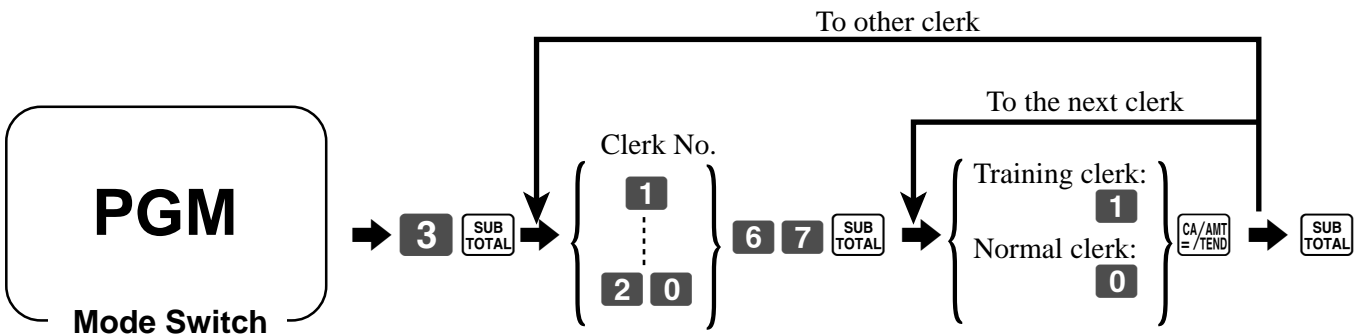

When a training clerk signs on, the cash register automatically enters the training mode. In the training mode, no operations are affected on any totalizers nor counters. The training mode symbols are printed in the columns of receipt entries produced in the training mode. The cash register exits the training mode when the training clerk signs off.

Convenient Operations and Setups

Programming clerk commission rate

Note: In addition to the commission rate program (this program), *do not* forget to program the commission status for item (department, PLU and flat-PLU).

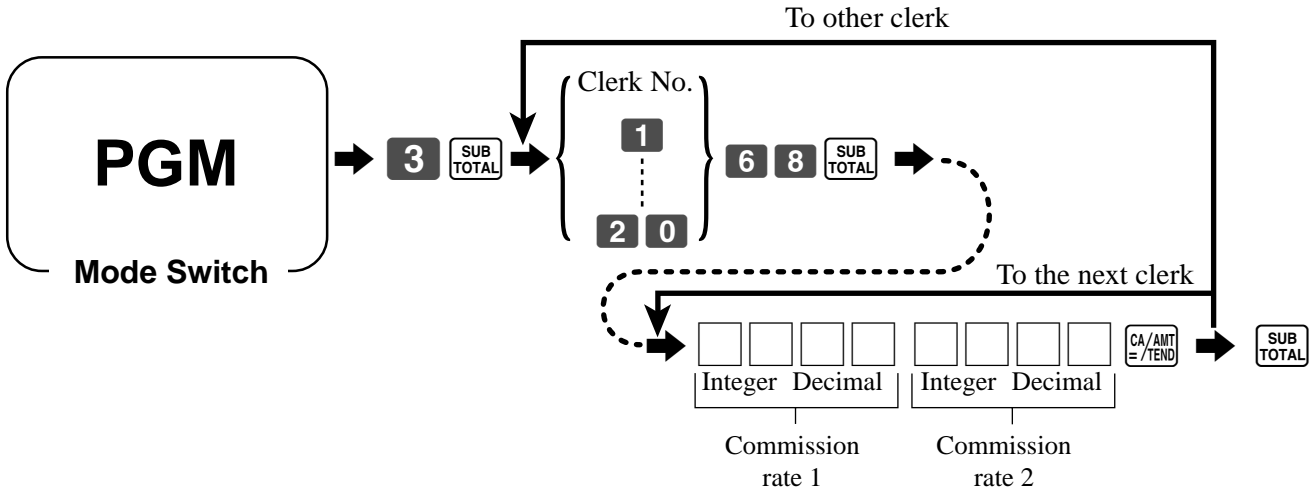

About the clerk interrupt function

The register can be programmed to allow the clerk interrupt function, which makes it possible for multiple clerks to simultaneously uses the same register. If a clerk starts registration of a transaction, another clerk can interrupt the original registration and begin new one. The original clerk can be later resume the interrupted original registration.

To use clerk interrupt function

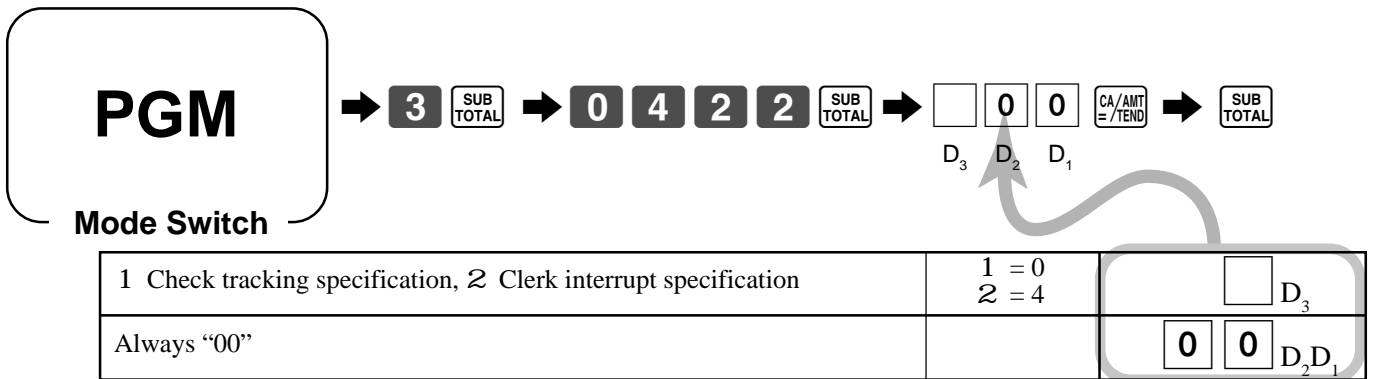

Programming descriptors and messages

The following descriptors and messages can be programmed;

- Report descriptor (such as gross total, net total, cash in drawer...)
- Grand total
- Special character (such as mode symbol, taxable symbol...)
- Read/reset report title
- Clerk name
- PLU item descriptor
- Messages (Logo, commercial and bottom message)
- Function key descriptor
- Department key descriptor

Programming report descriptor, grand total, special character, report title, receipt message and clerk name

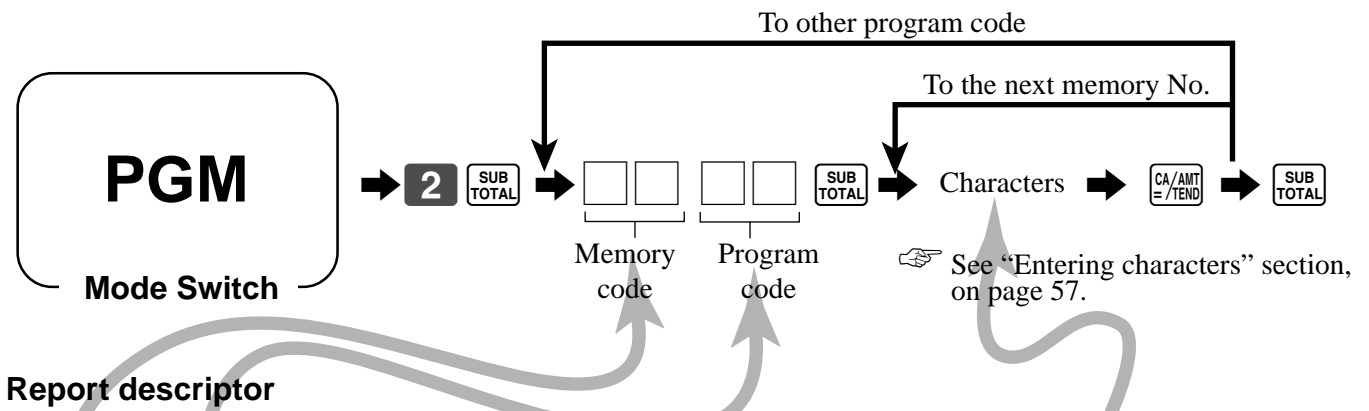

Report descriptor

Memory No.	Program code	Contents	Initial character	Yours																					
01	01	Gross total	GROSS TOTAL																						
02		Net total	NET TOTAL																						
03		Cash in drawer	CASH-INDW																						
04		Charge in drawer	CHARGE-INDW																						
05		Check in drawer	CHECK-INDW																						
06		Credit in drawer	CREDIT-INDW																						
07		Foreign currency cash in drawer 1	CE-CASH 1																						
08		Foreign currency check in drawer 1	CE-CHECK 1																						
09		Foreign currency cash in drawer 2	CE-CASH 2																						
10		Foreign currency check in drawer 2	CE-CHECK 2																						
11		Taxable amount 1	TAX-AMT 1																						
12		Tax 1	TAX 1																						
13		Taxable amount 2	TAX-AMT 2																						
14		Tax 2	TAX 2																						
15		Taxable amount 3	TAX-AMT 3																						
16		Tax 3	TAX 3																						
17		Taxable amount 4	TAX-AMT 4																						
18		Tax 4	TAX 4																						
19		not used																							
20		not used																							
21		not used																							
22		Rounding		ROUNDING AMT																					
23		Cancellation total		CANCEL TTL																					
24		Refund mode total		RF-MODE TTL																					
25		Clerk commission 1		COMMISSION 1																					
26		Clerk commission 2		COMMISSION 2																					
27		Calculator mode count		CALCULATOR																					
28		Non-link department total		NON-LINK DPT																					

Convenient Operations and Setups

Convenient Operations and Setups

Grand total, special character

Memory No.	Program code	Contents	Initial character	Yours					
01	20	Grand total	GRND TTL						
01	23	Amount/@/No./Quantity (2 each)	· @NoQT						
		Amount/@/No./Quantity (Australian GST) (2 each)	\$ @NoQT						
02		Item count/Customer (2 each)	NoCT						
03		Multiplication/Split pricing (2 each)	X /						
04		Taxable status 1 ~ 4 (2 each)	T1T2T3T4						
		Taxable status 1 (Australian GST) (2 each)	* T2T3T4						
05		All taxable status	*						
06		Foreign currency symbol (2 each)	* *						
07		REG mode/Refund mode (4 each)	REG RF						
08		not used (4)/Program mode (3)	PGM n (n=1-6)						
09		X/Z mode (4 each)	X Z						
10		CAL mode (4)	CAL						
11		Training mode	****						
12		Training symbol	*****						
13		Total symbol (Tendering)	TOTAL						
14		Change symbol	CHANGE						
15		not used							
16		Total symbol (Post receipt)	TOTAL						
17		Total symbol (% registration)	ST						
18		AM, PM (3 each)	AM PM						
19		Tax total	TAX						
20		Auto-program data sending	SEND PGM						
21		Auto-program data receiving	RECV PGM						
22		Auto-program	PGM						
23		Auto-program normal end message	END						
24		Auto-program error end message	ERROR						
25		Auto-program forced end message	**END**						
26		Total message on report	TOTAL						
27	Service total	SRVC TL							
28	Check number	CHECK-#							

Report title

Memory No.	Program code	Contents	Initial character	Yours					
01	24	Daily report title	DAILY						
02		PLU report title	PLU						
03		Hourly sales report title	HOURLY						
04		Group report title	GROUP						
05		Not used	CLERK						
06		Financial report title	FLASH						
07		Monthly report title	MONTHLY						
08		Periodic-1 report title	PERIODIC-1						
09		Periodic-2 report title	PERIODIC-2						
10		Individual report title							
11		Open check report title	OPEN CHECK						
12		Electronic journal report title	E-JOURNAL						

Clerk name

Memory No.	Program code	Contents	Initial character	Yours					
01	07	Clerk 01	CLERK 01						
02		Clerk 02	CLERK 02						
03		Clerk 03	CLERK 03						
04		Clerk 04	CLERK 04						
		Clerk 19	CLERK 05						
20		Clerk 20	CLERK 20						

Receipt message

Refer to “Programming receipt message/logo stamp control function” below.

Memory No.	Program code	Contents	Initial character	Yours
01	32	1st line of logo message		
02		2nd line of logo message	YOUR RECEIPT	
03		3rd line of logo message	THANK YOU	
04		4th line of logo message	CALL AGAIN	
05		5th line of logo message		
06		6th line of logo message		
07		1st line of commercial message		
08		2nd line of commercial message		
09		3rd line of commercial message		
10		4th line of commercial message		
11		5th line of commercial message		
12		1st line of bottom message		
13		2nd line of bottom message		
14		3rd line of bottom message		
15		4th line of bottom message		
16		5th line of bottom message		
17		1st line of Australian MOF msg.	TAX INVOICE	
18		2nd line of Australian MOF msg.	* INDICATES	
19		3rd line of Australian MOF msg.	TAXABLE SUPPLY	

Programming receipt message/logo stamp control function

1 Print graphic logo (electronic logo stamp), 2 Logo message	a	1 = 0 2 = 1	a+b+c = <input type="text"/> D ₈
Print commercial message.	b	No = 0 Yes = 2	
Print bottom message.	c	No = 0 Yes = 4	
Always “0000000”			<input type="text"/> 0 ~ <input type="text"/> 0 D ₇ ~D ₁

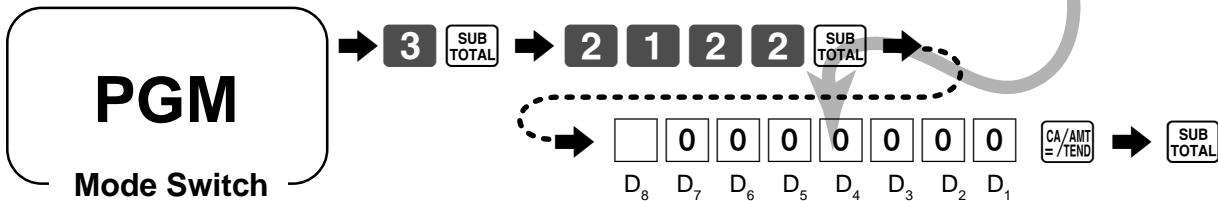

Programming department key descriptor

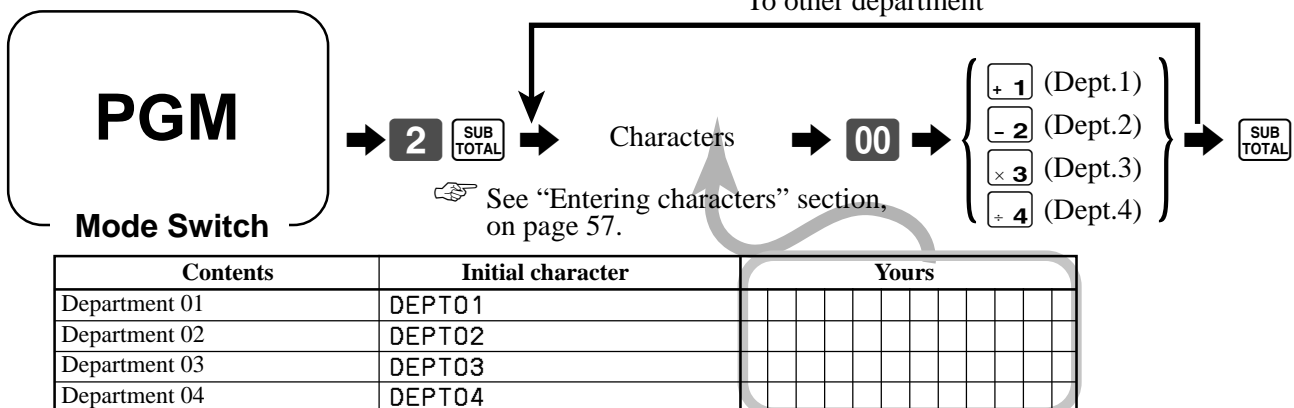

Convenient Operations and Setups

Programming PLU descriptor

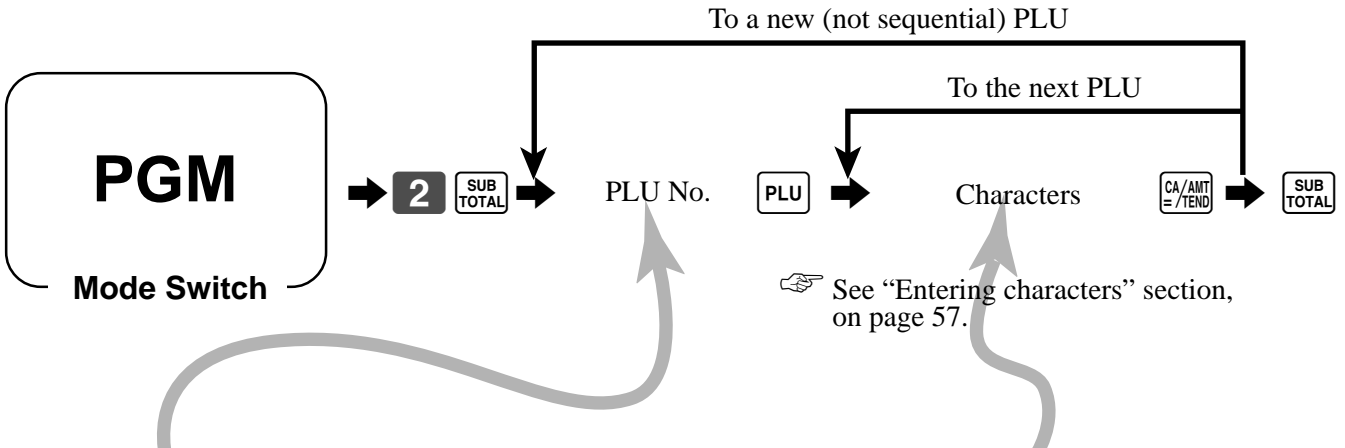

PLU No.	Contents	Initial character	Yours
001	PLU001	PLU0001	
002	PLU002	PLU0002	
003	PLU003	PLU0003	
004	PLU004	PLU0004	
005	PLU005	PLU0005	
006	PLU006	PLU0006	
007	PLU007	PLU0007	
008	PLU008	PLU0008	
009	PLU009	PLU0009	
010	PLU010	PLU0010	
011	PLU011	PLU0011	
012	PLU012	PLU0012	
013	PLU013	PLU0013	
014	PLU014	PLU0014	
015	PLU015	PLU0015	
016	PLU016	PLU0016	
017	PLU017	PLU0017	
018	PLU018	PLU0018	
019	PLU019	PLU0019	
020	PLU020	PLU0020	
021	PLU021	PLU0021	
022	PLU022	PLU0022	
023	PLU023	PLU0023	
024	PLU024	PLU0024	
025	PLU025	PLU0025	
026	PLU026	PLU0026	
027	PLU027	PLU0027	
028	PLU028	PLU0028	
029	PLU029	PLU0029	
030	PLU030	PLU0030	
031	PLU031	PLU0031	
032	PLU032	PLU0032	
033	PLU033	PLU0033	
034	PLU034	PLU0034	
035	PLU035	PLU0035	
036	PLU036	PLU0036	
037	PLU037	PLU0037	
038	PLU038	PLU0038	
039	PLU039	PLU0039	
1198	PLU1198	PLU1198	
1199	PLU1199	PLU1199	
1200	PLU1200	PLU1200	

Programming flat-PLU descriptor

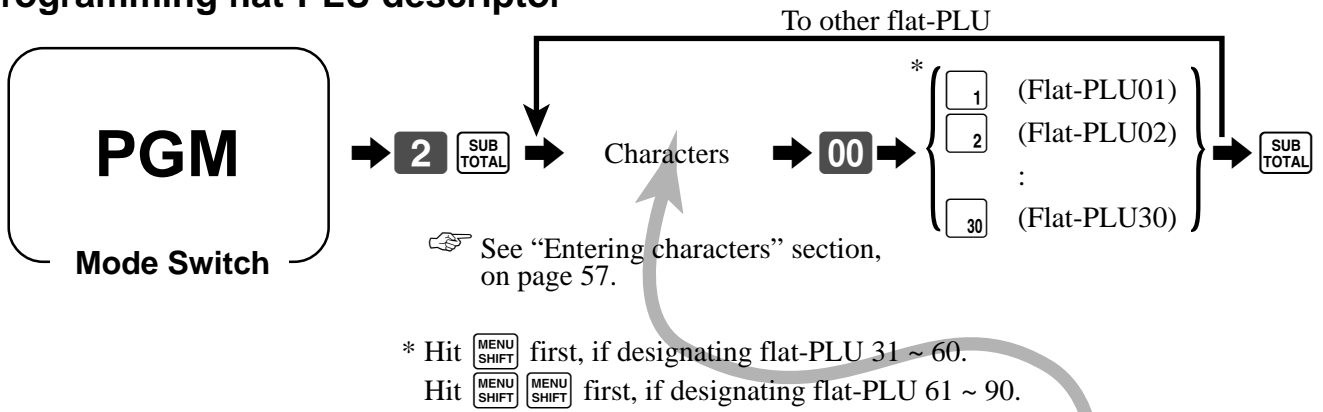

PLU No.	Contents	Initial character	Yours			
001	PLU001	PLU0001				
002	PLU002	PLU0002				
003	PLU003	PLU0003				
004	PLU004	PLU0004				
005	PLU005	PLU0005				
006	PLU006	PLU0006				
007	PLU007	PLU0007				
008	PLU008	PLU0008				
009	PLU009	PLU0009				
010	PLU010	PLU0010				
011	PLU011	PLU0011				
012	PLU012	PLU0012				
013	PLU013	PLU0013				
014	PLU014	PLU0014				
015	PLU015	PLU0015				
016	PLU016	PLU0016				
017	PLU017	PLU0017				
018	PLU018	PLU0018				
019	PLU019	PLU0019				
020	PLU020	PLU0020				
021	PLU021	PLU0021				
022	PLU022	PLU0022				
023	PLU023	PLU0023				
024	PLU024	PLU0024				
025	PLU025	PLU0025				
026	PLU026	PLU0026				
027	PLU027	PLU0027				
028	PLU028	PLU0028				
029	PLU029	PLU0029				
030	PLU030	PLU0030				
031	PLU031	PLU0031				
032	PLU032	PLU0032				
033	PLU033	PLU0033				
034	PLU034	PLU0034				
035	PLU035	PLU0035				
036	PLU036	PLU0036				
037	PLU037	PLU0037				
038	PLU038	PLU0038				
039	PLU039	PLU0039				
088	PLU088	PLU0088				
089	PLU089	PLU0089				
090	PLU090	PLU0090				

Convenient Operations and Setups

Programming function key descriptor

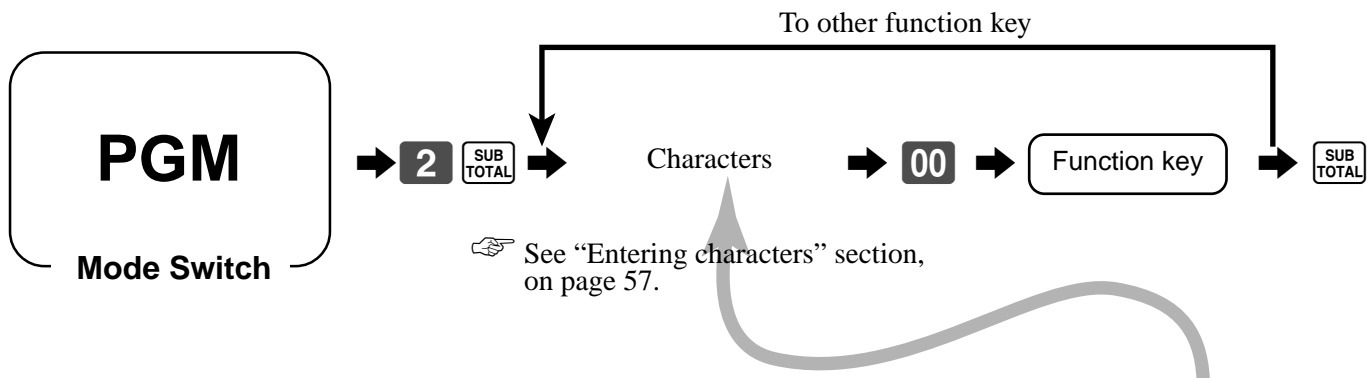

Contents	Initial character	Yours											
Cash/amount tendered	CASH												
Charge	CHARGE												
Check	CHECK												
Credit	CREDIT												
New balance	NEW-BAL												
Recall character	TEXT PRT												
Tip	TIP												
Received on account	RC												
Paid out	PD												
Minus	-												
Discount	%-												
Plus	+												
Premium	%+												
Manual tax	TAX												
Refund	REFUND												
Error correct/Cancel	ERR CORR												
Void	VOID												
Post receipt/Guest receipt	P/G RCT												
Non-add	#												
Non-add/No sale	#/NS												
No sale	NS												
No. of customer	COVERS												
Arrangement	ARG												
Currency exchange	CURR EXG												
VAT	VAT												
Price	PRICE												
PLU	PLU												
Tax shift	T/S												
Menu shift	MENU												
Open	OPEN												
Preset open	OPEN2												
Clerk No.	SIGN/ON												
Subtotal	TL												
Receipt on/off	R ON/OFF												
Multiplication/Date time	X												
New check	NEWCHK												
Old check	OLDCHK												
New/old check	CHECK												
Add check	ADDCHK												
“00” double zero	00												
“000” triple zero	000												
“.” decimal point	.												

Entering characters

In this section, the method to enter descriptors or messages (characters) to the cash register during programming is described.

Characters are specified by character keyboard or by codes. In the first half of this section, the usage of character keyboard is described. In the latter half, inputting method by character code is described.

Using character keyboard

	1	2	3	4	5	()	2	3			4	5		
	1	6	7	8	9	0	MENU SHIFT	C			PLU	FEED		
A	B	C	D	E	F	G	@	6	7	8	9	/	7	8
a	b	c	d	e	f	g	.					.	SPACE	DBL SIZE
H	I	J	K	L	M	N	#		4	5	6	*		
h	i	j	k	l	m	n	,					,		
O	P	Q	R	S	T	U	%		1	2	3	-	C	
o	p	q	r	s	t	u	:					+	#-2	
V	W	X	Y	Z	9	O	&		A	B		!	D	
v	w	x	y	z	CAPS	SHIFT			0	00	.	?		#-1

1 Alphabet keys

Used input to characters.

2 Menu shift key

Use this key to shift the flat-PLU key number from 1 through 30 to 31 through 60 or 61 through 90.

3 Clear key

Clears all input characters in the programming.

4 PLU key

Use this key to input PLU numbers.

5 Feed key

Hold this key down to feed paper from the printer.

6 Numeric keys

Used to enter program codes, memory number and character codes.

7 Space key

Set a space by depression.

8 Double size letter key

Specifies that the next character you input to a double size character. You must press this key before each double size character.

9 CAPS key

Pressing this key shifts the character from the lowercase letter to upper case letter.

O Shift key

Pressing this key shifts the character from the uppercase letter to lower case letter.

A Character fixed key

Enter when the alphabetic entry for a descriptor, name or message has been completed.

B Backspace/Character code fixed key

Registers one character with code (2 or 3 digits). Clears the last input character, much like a back space key.

C Program end key

Terminates the character programming.

D Character enter key

Registers the programmed characters.

Example:

Input “ **A** p p l e J u i c e ”,
enter “DBL SIZE”, “A”, “SHIFT”, “p”, “p”, “l”, “e”, “SPACE”, “CAPS”, “J”, “SHIFT”, “u”, “i”, “c”, “e” .

Convenient Operations and Setups







Entering characters by code

Every time you enter a character, choose character codes by the character code list (below) and press the  key to settle it.

Example:

Input “  p p l e  u i c e ”,
 enter “ 255  65  112  112  108  101  32  74  117  105  99  101  ”.

Character code list

Chara	Code	Chara	Code	Chara	Code	Chara	Code	Chara	Code	Chara	Code	Chara	Code
Space	32	0	48	@	64	P	80	'	96	p	112	Ç	128
!	33	1	49	A	65	Q	81	a	97	q	113	ü	129
"	34	2	50	B	66	R	82	b	98	r	114	é	130
#	35	3	51	C	67	S	83	c	99	s	115	â	131
\$	36	4	52	D	68	T	84	d	100	t	116	ä	132
%	37	5	53	E	69	U	85	e	101	u	117	à	133
&	38	6	54	F	70	V	86	f	102	v	118	å	134
'	39	7	55	G	71	W	87	g	103	w	119	ç	135
(40	8	56	H	72	X	88	h	104	x	120	ê	136
)	41	9	57	I	73	Y	89	i	105	y	121	ë	137
*	42	:	58	J	74	Z	90	j	106	z	122	è	138
+	43	;	59	K	75	[91	k	107	{	123	ï	139
,	44	<	60	L	76	\	92	l	108		124	î	140
-	45	=	61	M	77]	93	m	109	}	125	ì	141
.	46	>	62	N	78	^	94	n	110	~	126	Ä	142
/	47	?	63	O	79	_	95	o	111		127	Å	143
É	144	á	160		176	Ł	192	ø	208	Ó	224	-	240
æ	145	í	161		177	ł	193	ð	209	õ	225	±	241
Æ	146	ó	162		178	¬	194	Ê	210	Ô	226	_	242
ô	147	ú	163		179	†	195	Ë	211	Ò	227	3/4	243
ö	148	ñ	164	‡	180	—	196	È	212	ó	228	¶	244
ò	149	Ñ	165	Á	181	†	197	€	213	Õ	229	§	245
û	150	ª	166	Â	182	ã	198	Í	214	µ	230	÷	246
ù	151	º	167	Ã	183	Ä	199	Î	215	þ	231	,	247
ÿ	152	¿	168	©	184	Ł	200	Ï	216	Ɔ	232	°	248
Ö	153	®	169	†	185	Ɔ	201	Ɔ	217	Ú	233	¨	249
Ü	154	¬	170		186	ł	202	Ɔ	218	Û	234	•	250
ø	155	1/2	171	Ɔ	187	Ɔ	203		219	Ü	235	¹	251
£	156	1/4	172	Ɔ	188	†	204		220	ý	236	³	252
Ø	157	¡	173	¢	189	—	205		221	Ý	237	²	253
×	158	«	174	¥	190	†	206	ì	222	—	238		254
f	159	»	175	ı	191	¤	207		223	'	239	Double size	255

 : for R/J printer only.

The “Ä”, “Ö”, “Ü” characters are displayed as “A”, “O”, “U”.

Department key feature programming

There are two different methods you can use to assign features to department keys. With “Batch feature programming”, you can use a single operation to assign multiple features. “Individual feature programming”, on the other hand, let you assign features one-by-one. This method is recommended for programming of special features to individual department keys.

Batch feature programming

When using this procedure to assign multiple features to departments, use 9-digit codes that you create using the following procedure

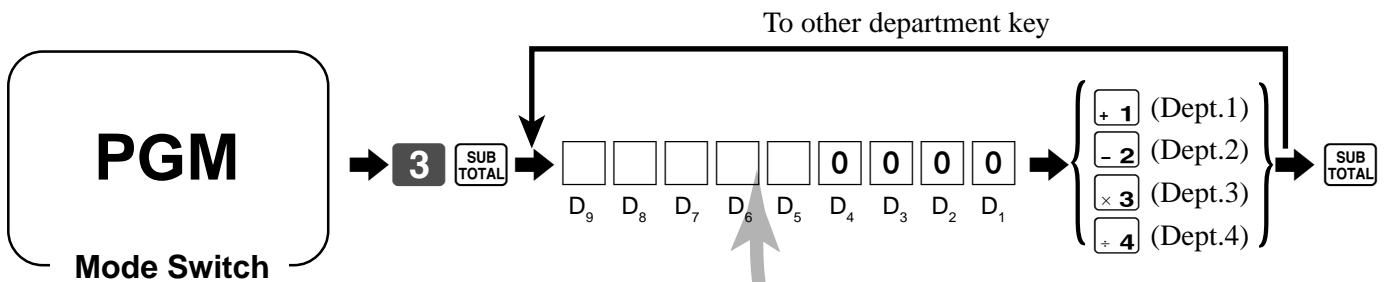

Negative department	a	No = 0 Yes = 2	a+b = <input type="text"/> D ₉
Hash department	b	No = 0 Yes = 4	
Single item sale		No = 0 Yes = 1	<input type="text"/> D ₈
High digit limit specification		Significant number	<input type="text"/> D ₇
Taxable status 1	a	No = 0 Yes = 1	a+b+c = <input type="text"/> D ₆
Taxable status 2	b	No = 0 Yes = 2	
Taxable status 3	c	No = 0 Yes = 4	
Commission 1	a	No = 0 Yes = 1	a+b+c = <input type="text"/> D ₅
Commission 2	b	No = 0 Yes = 2	
Taxable status 4	c	No = 0 Yes = 4	
Always “0000”			<input type="text"/> 0 ~ <input type="text"/> 0 D ₄ ~ D ₁

Convenient Operations and Setups

Individual feature programming

With this procedure, you can assign individual features to specific departments. Please select the command code of the contents you want to program, and follow the procedure below.

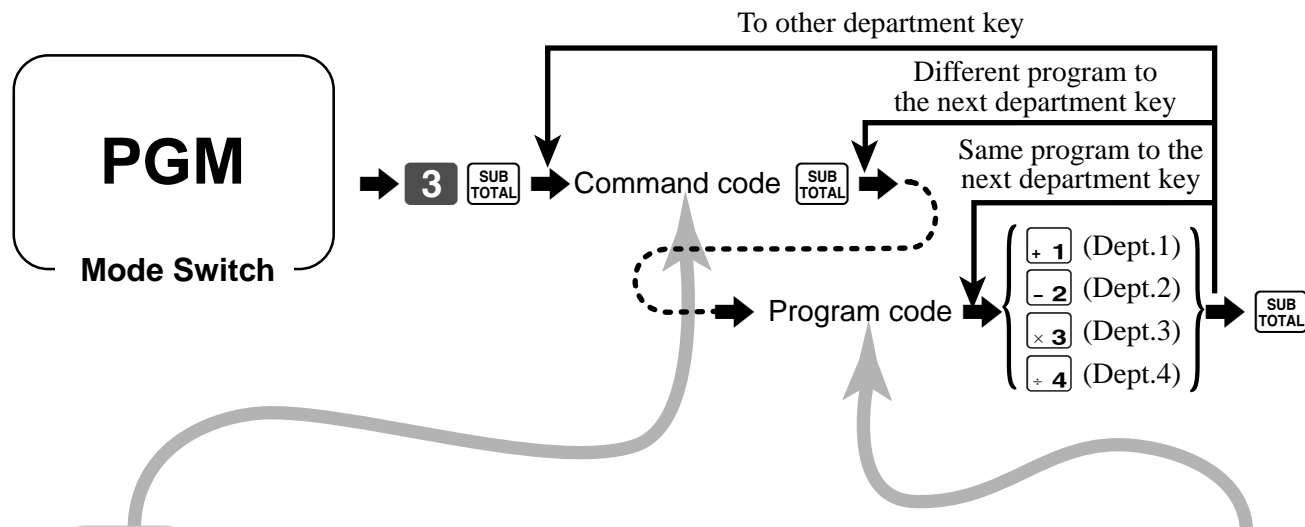

Command code	Contents/selection			Program code
0166	Negative department	a	No = 0 Yes = 2	a+b = <input type="text"/>
	Hash department	b	No = 0 Yes = 4	
1866	Single item sale		No = 0 Yes = 1	<input type="text"/>
1566	High digit limit specification		Significant number	<input type="text"/>
0366	Taxable status 1	a	No = 0 Yes = 1	a+b+c = <input type="text"/>
	Taxable status 2	b	No = 0 Yes = 2	
	Taxable status 3	c	No = 0 Yes = 4	
0966	Commission 1	a	No = 0 Yes = 1	a+b+c = <input type="text"/>
	Commission 2	b	No = 0 Yes = 2	
	Taxable status 4	c	No = 0 Yes = 4	

To program a unit price to a department key, please refer the page 27.

PLU feature programming

There are two different methods you can use to assign features to PLUs. With “Batch feature programming”, you can use a single operation to assign multiple features. “Individual feature programming”, on the other hand, let you assign features one-by-one. This method is recommended for programming of special features to individual PLUs.

Batch feature programming

When using this procedure to assign multiple features to PLUs, use 9-digit codes that you create using the following procedure.

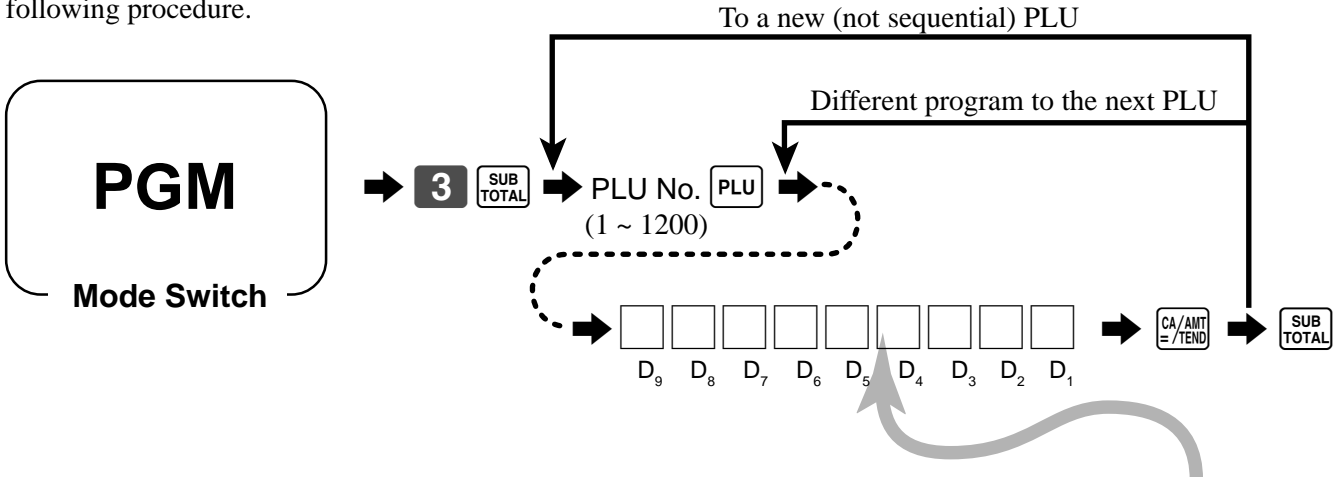

Condiment PLU	a	No = 0 Yes = 1	a+b+c = <input type="text"/> D ₉
Negative PLU	b	No = 0 Yes = 2	
Hash PLU	c	No = 0 Yes = 4	
Single item sale	a	No = 0 Yes = 1	a+b = <input type="text"/> D ₈
Treat as subdepartment/PLU.	b	PLU = 0 Subdept. = 4	
High digit limit specification (for subdepartment)		Significant number	<input type="text"/> D ₇
Taxable status 1	a	No = 0 Yes = 1	a+b+c = <input type="text"/> D ₆
Taxable status 2	b	No = 0 Yes = 2	
Taxable status 3	c	No = 0 Yes = 4	
Commission 1	a	No = 0 Yes = 1	a+b+c = <input type="text"/> D ₅
Commission 2	b	No = 0 Yes = 2	
Taxable status 4	c	No = 0 Yes = 4	
Department link (00 ~ 08)		Significant numbers	<input type="text"/> <input type="text"/> D ₄ D ₃
Group link (00 ~ 50)		Significant numbers	<input type="text"/> <input type="text"/> D ₂ D ₁

Convenient Operations and Setups

Individual feature programming

With this procedure, you can assign individual features to specific PLUs. Please select the command code of the contents you want to program, and follow the procedure below.

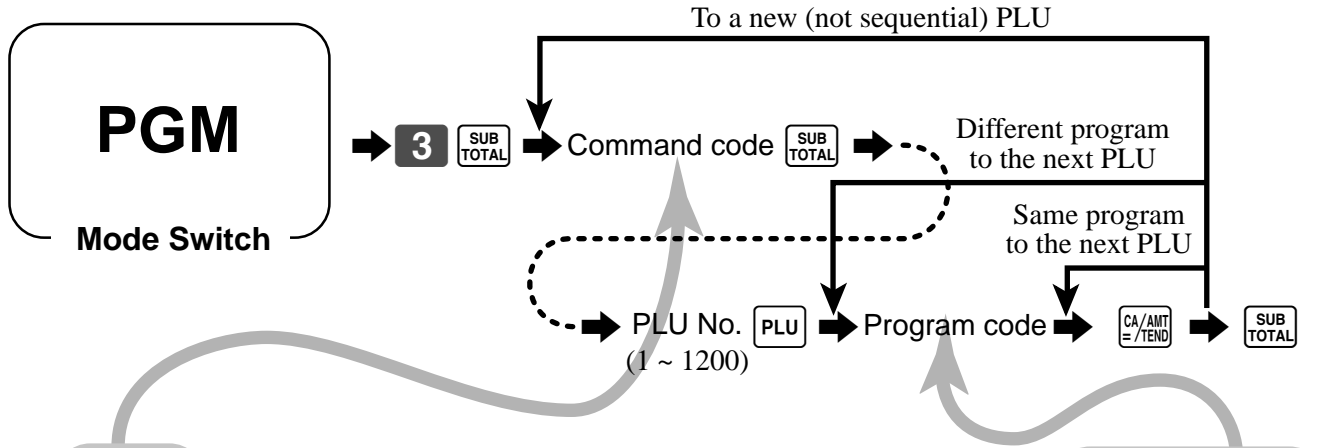

Command code	Contents/selection			Program code
0166	Condiment PLU	a	No = 0 Yes = 1	a+b+c = <input type="text"/>
	Negative PLU	b	No = 0 Yes = 2	
	Hash PLU	c	No = 0 Yes = 4	
1866	Single item sale	a	No = 0 Yes = 1	a+b = <input type="text"/>
	Treat as subdepartment (If "No", treat as PLU.)	b	No = 0 Yes = 4	
1566	High digit limit specification		Significant number	<input type="text"/>
0366	Taxable status 1	a	No = 0 Yes = 1	a+b+c = <input type="text"/>
	Taxable status 2	b	No = 0 Yes = 2	
	Taxable status 3	c	No = 0 Yes = 4	
0966	Commission 1	a	No = 0 Yes = 1	a+b+c = <input type="text"/>
	Commission 2	b	No = 0 Yes = 2	
	Taxable status 4	c	No = 0 Yes = 4	
1166	Department link (00 ~ 08)		Significant numbers	<input type="text"/> <input type="text"/>
	Group link (00 ~ 50)			<input type="text"/> <input type="text"/>

To program a unit price to a PLU or a subdepartment, please refer to the page 29.

Flat-PLU feature programming

There are two different methods you can use to assign features to flat-PLUs. With “Batch feature programming”, you can use a single operation to assign multiple features.

“Individual feature programming”, on the other hand, let you assign features one-by-one. This method is recommended for programming of special features to individual flat-PLUs.

Batch feature programming

When using this procedure to assign multiple features to flat-PLUs, use 9-digit codes that you create using the following procedure.

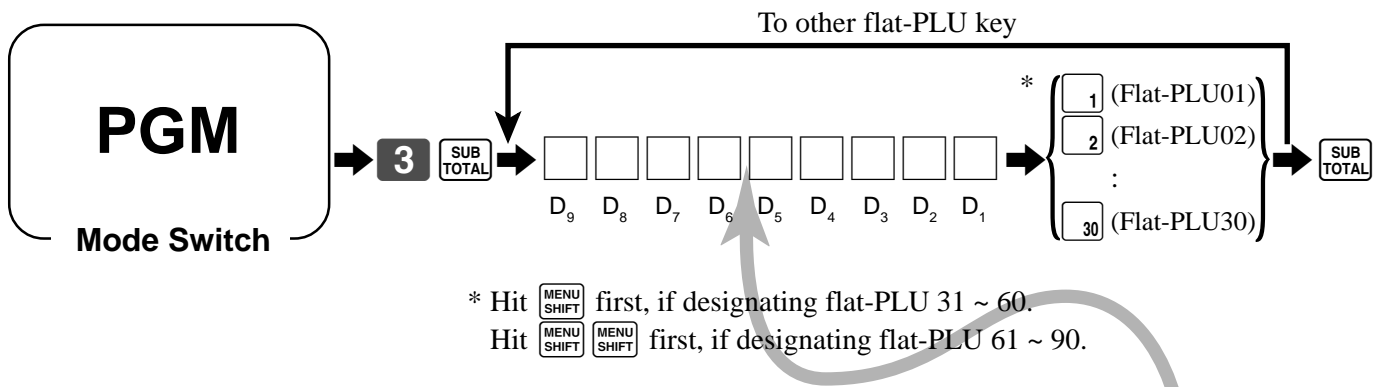

Condiment PLU	a	No = 0 Yes = 1	a+b+c = <input type="text"/> D ₉
Negative PLU	b	No = 0 Yes = 2	
Hash PLU	c	No = 0 Yes = 4	
Single item sale		No = 0 Yes = 1	<input type="text"/> D ₈
High digit limit specification		Significant number	<input type="text"/> D ₇
Taxable status 1	a	No = 0 Yes = 1	a+b+c = <input type="text"/> D ₆
Taxable status 2	b	No = 0 Yes = 2	
Taxable status 3	c	No = 0 Yes = 4	
Commission 1	a	No = 0 Yes = 1	a+b+c = <input type="text"/> D ₅
Commission 2	b	No = 0 Yes = 2	
Taxable status 4	c	No = 0 Yes = 4	
Department link (00 ~ 08)		Significant numbers	<input type="text"/> <input type="text"/> D ₄ D ₃
Group link (00 ~ 50)		Significant numbers	<input type="text"/> <input type="text"/> D ₂ D ₁

Convenient Operations and Setups

Individual feature programming

With this procedure, you can assign individual features to specific flat-PLUs. Please select the command code of the contents you want to program, and follow the procedure below.

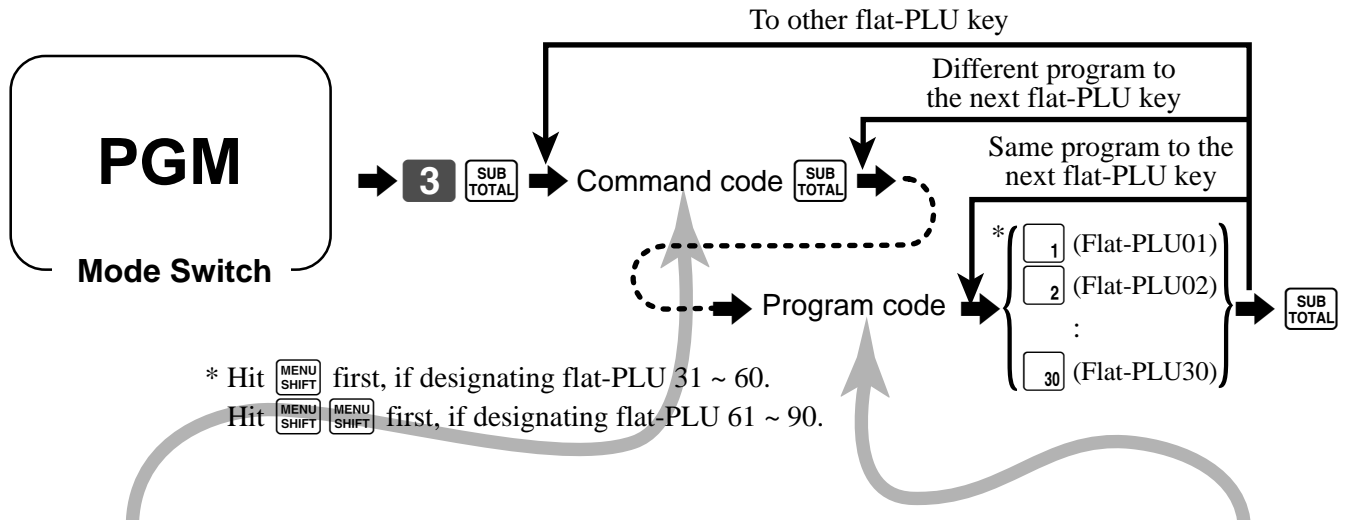

Command code	Contents/selection			Program code
0166	Condiment PLU	a	No = 0 Yes = 1	a+b+c = <input type="text"/>
	Negative PLU	b	No = 0 Yes = 2	
	Hash PLU	c	No = 0 Yes = 4	
1866	Single item sale		No = 0 Yes = 1	<input type="text"/>
1566	High digit limit specification		Significant number	<input type="text"/>
0366	Taxable status 1	a	No = 0 Yes = 1	a+b+c = <input type="text"/>
	Taxable status 2	b	No = 0 Yes = 2	
	Taxable status 3	c	No = 0 Yes = 4	
0966	Commission 1	a	No = 0 Yes = 1	a+b+c = <input type="text"/>
	Commission 2	b	No = 0 Yes = 2	
	Taxable status 4	c	No = 0 Yes = 4	
1166	Department link (00 ~ 08)		Significant numbers	<input type="text"/> <input type="text"/>
	Group link (00 ~ 50)			<input type="text"/> <input type="text"/>

To program a unit price to a PLU or a subdepartment, please refer to the page 31.

Registering example

REG

Mode Switch

Locking out and releasing high digit limitation

First of all, you should allocate the **OPEN** key (refer to page 82).

	OPERATION	RECEIPT												
<table border="1" style="width: 100%; border-collapse: collapse;"> <tr> <td rowspan="4" style="text-align: center;">Item</td> <td>Unit price</td> <td style="text-align: right;">\$10.50</td> </tr> <tr> <td>Quantity</td> <td style="text-align: center;">1</td> </tr> <tr> <td>Dept.</td> <td style="text-align: center;">3</td> </tr> <tr> <td>Max. digit</td> <td style="text-align: center;">(3)</td> </tr> <tr> <td>Payment</td> <td>Cash</td> <td style="text-align: right;">\$11.00</td> </tr> </table> <p>(): Preset value</p>	Item	Unit price	\$10.50	Quantity	1	Dept.	3	Max. digit	(3)	Payment	Cash	\$11.00	<p>1 0 5 0 × 3</p> <p>ERROR ALARM (Exceeding max. digits)</p> <p>C CAC</p> <p>OPEN</p> <p>Cancels limitations for next entry</p> <p>1 0 5 0 × 3</p> <p>SUB TOTAL</p> <p>1 1 00 CA/AMT =/TEND</p>	<p>REG 15-03-2002 12:40 CLERK 01 000030</p> <p>DEPT03 .10.50 TOTAL .10.50 CASH .11.00 CHANGE .0.50</p>
Item		Unit price	\$10.50											
		Quantity	1											
		Dept.	3											
	Max. digit	(3)												
Payment	Cash	\$11.00												

Single item sales items

You can issue a receipt by simply touching the single item sales department or PLU. The following examples show how you register single-item-sale departments. Registration of single item sale PLUs is identical.

Single item

	OPERATION	RECEIPT									
<table border="1" style="width: 100%; border-collapse: collapse;"> <tr> <td rowspan="4" style="text-align: center;">Item</td> <td>Unit price</td> <td style="text-align: right;">\$2.00</td> </tr> <tr> <td>Quantity</td> <td style="text-align: center;">1</td> </tr> <tr> <td>Dept.</td> <td style="text-align: center;">4</td> </tr> <tr> <td>Sales status</td> <td style="text-align: center;">(Single item)</td> </tr> </table> <p>(): Preset value</p>	Item	Unit price	\$2.00	Quantity	1	Dept.	4	Sales status	(Single item)	<p>2 00 + 4</p>	<p>REG 15-03-2002 12:45 CLERK 01 000031</p> <p>DEPT04 .2.00 CASH .2.00</p>
Item		Unit price	\$2.00								
		Quantity	1								
		Dept.	4								
	Sales status	(Single item)									

Multiple item sale

	OPERATION	RECEIPT																			
<table border="1" style="width: 100%; border-collapse: collapse;"> <tr> <td rowspan="4" style="text-align: center;">Item 1</td> <td>Unit price</td> <td style="text-align: right;">\$2.00</td> </tr> <tr> <td>Quantity</td> <td style="text-align: center;">1</td> </tr> <tr> <td>Dept.</td> <td style="text-align: center;">3</td> </tr> <tr> <td>Sales status</td> <td style="text-align: center;">(Normal)</td> </tr> <tr> <td rowspan="3" style="text-align: center;">Item 2</td> <td>Unit price</td> <td style="text-align: right;">\$5.00</td> </tr> <tr> <td>Quantity</td> <td style="text-align: center;">1</td> </tr> <tr> <td>Dept.</td> <td style="text-align: center;">4</td> </tr> <tr> <td>Payment</td> <td>Cash</td> <td style="text-align: right;">\$7.00</td> </tr> </table> <p>(): Preset value</p>	Item 1	Unit price	\$2.00	Quantity	1	Dept.	3	Sales status	(Normal)	Item 2	Unit price	\$5.00	Quantity	1	Dept.	4	Payment	Cash	\$7.00	<p>2 00 × 3</p> <p>5 00 + 4</p> <p>Single item status is not effective during transaction.</p> <p>CA/AMT =/TEND</p> <p>It is necessary to press the finalize key.</p>	<p>REG 15-03-2002 12:50 CLERK 01 000032</p> <p>DEPT03 .2.00 DEPT04 .5.00</p>
Item 1		Unit price	\$2.00																		
		Quantity	1																		
		Dept.	3																		
	Sales status	(Normal)																			
Item 2	Unit price	\$5.00																			
	Quantity	1																			
	Dept.	4																			
Payment	Cash	\$7.00																			

Note: The single item sales department or PLU should be registered at the top of the transaction, otherwise the transaction is not finalized. It is necessary to press **CA/AMT =/TEND**, **CR** or **CHK** key.

Convenient Operations and Setups

Examples of registering subdepartments

Single item sale

Item	Unit price	\$6.00
	Quantity	1
	Subdept.	15
Payment	Cash	\$10.00

OPERATION

1 5 **PLU**
 PLU (subdepartment) code
6 00 **ADD/PRICE**
 Unit price
1 0 00 **CA/AMT = /TEND**

RECEIPT

REG	15-03-2002	12:55
CLERK	01	000033
PLU0015		.6.00
TOTAL		.6.00
CASH		.10.00
CHANGE		.4.00

Repeat

Item 1	Unit price	(\$3.00)
	Quantity	3
	Subdept.	15
Item 2	Unit price	\$2.00
	Quantity	2
	Subdept.	15
Payment	Cash	\$20.00

(): Preset value

OPERATION

1 5 **PLU**
ADD/PRICE
 Hit **ADD/PRICE** without a unit price recalls preset price.
ADD/PRICE
ADD/PRICE
ADD/PRICE
1 5 **PLU**
2 00 **ADD/PRICE**
ADD/PRICE
SUB TOTAL
2 0 00 **CA/AMT = /TEND**

RECEIPT

REG	15-03-2002	13:00
CLERK	01	000034
PLU0015		.3.00
PLU0015		.3.00
PLU0015		.3.00
PLU0015		.2.00
PLU0015		.2.00
TOTAL		.13.00
CASH		.20.00
CHANGE		.7.00

Multiplication

Item	Unit price	\$6.00
	Quantity	1.25
	Subdept.	15
Payment	Cash	\$10.00

OPERATION

1 . 2 5 **X / DATE TIME**
 Quantity
 (4-digit integer/2-digit decimal)
1 5 **PLU**
6 00 **ADD/PRICE**
SUB TOTAL
1 0 00 **CA/AMT = /TEND**

RECEIPT

REG	15-03-2002	13:05
CLERK	01	000035
1.25	X	@6.00
PLU0015		.7.50
TOTAL		.7.50
CASH		.10.00
CHANGE		.2.50

Percent key feature programming

In this section, detail information of (discount) and (premium) is described.

Programming to the percent key

To program a percent rate, please refer to the page 33.

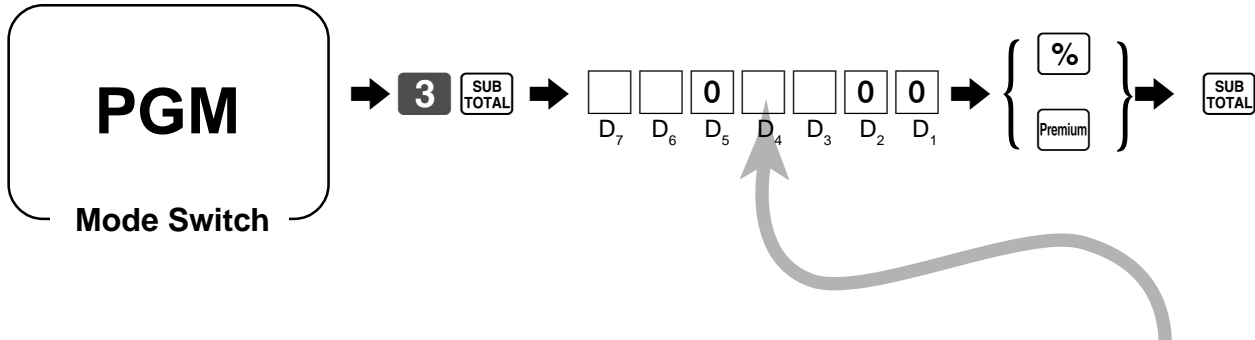

Fraction control, round off = 0, cut off = 1, round up = 2	Significant number	<input type="checkbox"/> D ₇
Prohibit manual entry to override programmed percentage.	No = 0 Yes = 2	<input type="checkbox"/> D ₆
Always "0"		<input type="text" value="0"/> D ₅
Taxable status 1	a No = 0 Yes = 1	a+b+c = <input type="checkbox"/> D ₄
Taxable status 2	b No = 0 Yes = 2	
Taxable status 3	c No = 0 Yes = 4	
Commission 1	a No = 0 Yes = 1	a+b+c = <input type="checkbox"/> D ₃
Commission 2	b No = 0 Yes = 2	
Taxable status 4	c No = 0 Yes = 4	
Always "00"		<input type="text" value="0"/> <input type="text" value="0"/> D ₂ D ₁

Convenient Operations and Setups

Registering discounts and premiums

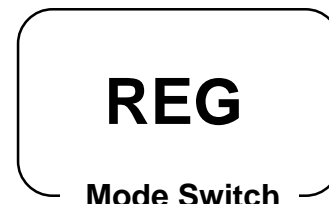

Discount for Items and subtotals

Refer to “Registering discounts” in “Basic Operations and Setups” on page 34.

Premium for Items and subtotals

First of all, allocate the premium key on the keyboard.

OPERATION

RECEIPT

Item 1	Unit price	(\$10.00)
	Quantity	1
	Dept.	4
Premium	Rate	7%
Item 2	Unit price	(\$5.00)
	Quantity	1
	PLU	32
Subtotal		
Premium	Rate	(5%)
Payment	Cash	\$20.00

(): Preset value

÷ **4**
7 Premium
 Applies the input value as a premium rate (7%).
3 2 PLU
SUB TOTAL
Premium
 Applies the preset premium rate (5%) to the subtotal.

REG	15-03-2002	13:15
CLERK	01	000037
DEPT04		· 10.00
7%		
%+		· 0.70
PLU0032		· 5.00
ST		· 15.70
5%		
%+		· 0.79
TOTAL		· 16.49
CASH		· 20.00
CHANGE		· 3.51



SUB TOTAL
2 0 00 CA/AMT =/TEND

- You can manually input rates up to 4 digits long (0.01% to 99.99%).

Taxable status of the % and Premium key

- Whenever you perform a discount/premium operation on the last item registered, the tax calculation for discount/premium amount is performed in accordance with the tax status programmed for that item.
- Whenever you perform a discount/premium operation on a subtotal amount, the tax calculation for the subtotal amount is performed in accordance with the tax status programmed for the key.

Currency exchange programming

When the  key is pressed, a current subtotal including tax is converted directly into foreign currency and the result is displayed, and the subsequent finalization is handled using the foreign currency. The currency exchange function is released by finalizing a transaction, partial tender operation, receipt issuance, or by pressing the  key. First of all, the  key should be allocated, refer to page 82.

Currency exchange rate programming

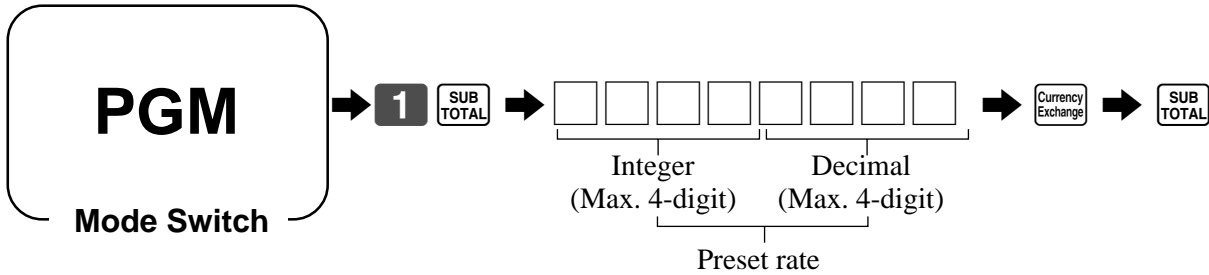

Example:

\$1.00 = ¥110.50 ⇨ **1 · 1 0 5**
 ¥100 = \$0.9050 ⇨ **0 · 9 0 5**

Currency exchange feature programming

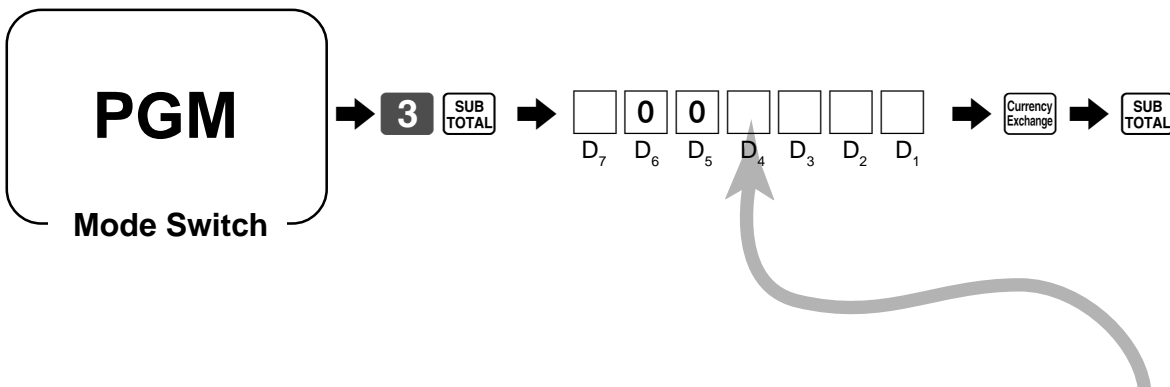

Fraction control, round off = 0, cut off = 1, round up = 2	Significant number	<input type="text"/> D ₇
Always "00"		<input type="text"/> 0 <input type="text"/> 0 D ₆ D ₅
Monetary symbol for foreign currency; Local currency symbol = 0 Monetary symbol 1 (in the special character program) = 1 Monetary symbol 2 (in the special character program) = 2	Significant number	<input type="text"/> D ₄
Totallizer selection; 1 Currency exchange 1, 2 Currency exchange 2	1 = 0 2 = 2	<input type="text"/> D ₃
Digit separator for foreign currency; Period = 0, Comma = 2	Significant number	<input type="text"/> D ₂
Monetary system code (decimal places) following currency exchange operation; Same as local currency = 0, <input type="text"/> <input type="text"/> = 1, <input type="text"/> <input type="text"/> <input type="text"/> = 2, <input type="text"/> = 3	Significant number	<input type="text"/> D ₁

Convenient Operations and Setups

Registering foreign currency











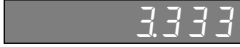

1) Full amount tender in foreign currency

* Preprogrammed exchange rate: ¥ 1 = \$0.0090

Important!

Tenders in a foreign currency can be registered using the **CA/AMT = /TEND** and **CHK** keys only. Other finalize keys cannot be used.

OPERATION	DISPLAY	RECEIPT																											
1 0 00 + 1 ← Enter the unit price and press the applicable department key.	 (Displays in \$)	<table border="1"> <tr> <td>REG</td> <td>15-03-2002</td> <td>13:20</td> </tr> <tr> <td>CLERK</td> <td>01</td> <td>000038</td> </tr> <tr> <td>DEPT01</td> <td></td> <td>· 10.00</td> </tr> <tr> <td>DEPT02</td> <td></td> <td>· 20.00</td> </tr> <tr> <td>TOTAL</td> <td></td> <td>· 30.00</td> </tr> <tr> <td>CURR EXG</td> <td></td> <td></td> </tr> <tr> <td>CASH</td> <td></td> <td>¥5,000</td> </tr> <tr> <td>CASH</td> <td></td> <td>· 45.00</td> </tr> <tr> <td>CHANGE</td> <td></td> <td>· 15.00</td> </tr> </table>	REG	15-03-2002	13:20	CLERK	01	000038	DEPT01		· 10.00	DEPT02		· 20.00	TOTAL		· 30.00	CURR EXG			CASH		¥5,000	CASH		· 45.00	CHANGE		· 15.00
REG	15-03-2002		13:20																										
CLERK	01		000038																										
DEPT01			· 10.00																										
DEPT02			· 20.00																										
TOTAL		· 30.00																											
CURR EXG																													
CASH		¥5,000																											
CASH		· 45.00																											
CHANGE		· 15.00																											
2 0 00 - 2 ← Enter the next unit price and press the applicable department key.	 (Displays in \$)																												
 ← Press the  key without entering a numeric value. This operation converts the subtotal (including tax) dollar value into yen by applying a preprogrammed exchange rate. The result is shown on the display but not printed on the receipt or journal.	 (Displays in ¥: 3,333)																												
5 0 00  ← Enter the amount tendered in yen and press the  key. This operation converts the entered yen amount into dollars by applying a preprogrammed exchange rate. The result is shown on the display.	 (Displays in \$: 45.00)																												
 ← Press to finalize the transaction. Note that you do not need to reenter the dollar amount. The register automatically calculates the change amount due in dollars and shows it on the display, receipts and journal.	 (Displays in \$)																												

2) Partial tender in a foreign currency

* Preprogrammed exchange rate: ¥ 1 = \$0.0090

Important!

Partial tender in a foreign currency can be registered using the **CA/AMT = /TEND** key and **CHK** keys only. Other finalization keys cannot be used, but the remaining tender can be finalized using any finalize key.

OPERATION

DISPLAY

RECEIPT

1 0 00 **+ 1**

← Enter the unit price and press the applicable department key.

10.00
(Displays in \$)

2 0 00 **- 2**

← Enter the next unit price and press the applicable department key.

20.00
(Displays in \$)

Currency Exchange

← Press the **Currency Exchange** key without entering a numeric value. This operation converts the subtotal (including tax) dollar value into yen by applying a preprogrammed exchange rate. The result is shown on the display but not printed on the receipt or journal.

3333
(Displays in ¥: 3,333)

2 0 00 **Currency Exchange**

← Enter the partial amount tendered in yen and press the **Currency Exchange** key. This operation converts the entered yen amount into dollars by applying a preprogrammed exchange rate. The result is shown on the display.

18.00
(Displays in \$: 18.00)

CA/AMT = /TEND

← Press the **CA/AMT = /TEND** key to specify cash tender for the yen partial tender. Note that you do not need to reenter the dollar amount. The register automatically deducts the dollar equivalent of the yen amount tendered from the total amount due and shows the amount on the display.

12.00
(Displays in \$)

CHK

← Press to finalize the transaction.

12.00
(Displays in \$)

REG	15-03-2002	13:25
CLERK	01	000039
DEPT01		· 10.00
DEPT02		· 20.00
TOTAL		· 30.00
CURR EXG		
CASH		¥2,000
CASH		· 18.00
CHECK		· 12.00

Convenient Operations and Setups

Check tracking system

With the TK-T200 check tracking system, you can program the cash register to store the transaction total only (includes total amount, check number, clerk number store number and date/time) or registration full details.

To use check tracking specification

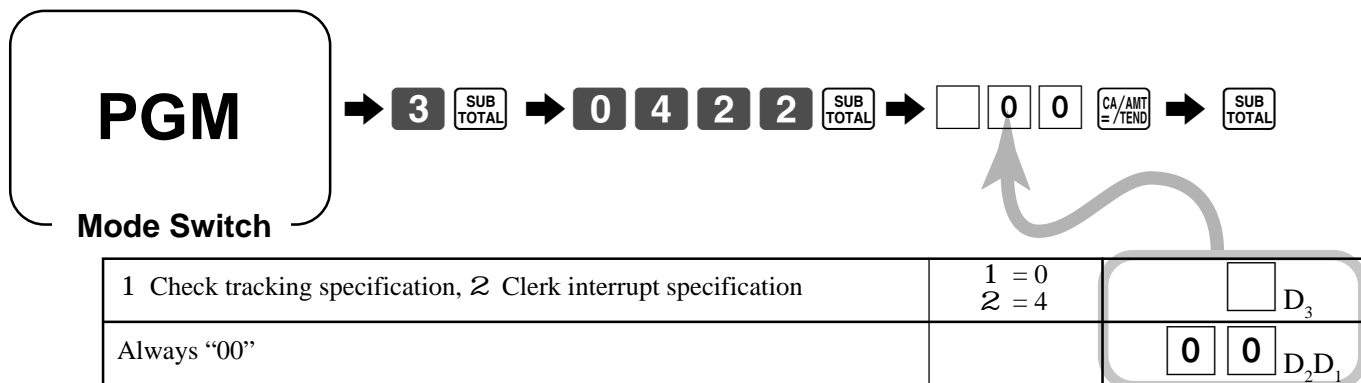

Registering examples



Opening a check

OPERATION			RECEIPT	
Check	number	1234	1 2 3 4 NEW	REG 15-03-2002 13:25
Item 1	Unit price	(\$10.00)	Input a new check number up to 8 digits.	CLERK 01 000038
	Quantity	1		NEWCHK 1234 — Check No.
	Dept.	4		DEPT04 .10.00
Item 2	Unit price	(\$5.00)	3 2 PLU	PLU0032 .5.00
	Quantity	1	SUB TOTAL	SRVC TL .15.00
	PLU	32	NB	

(): Preset value

Press **NB** to temporarily finalize the transaction.

Adding to a check

OPERATION			RECEIPT	
Check	number	1234	1 2 3 4 OLD	REG 15-03-2002 13:30
Item	Unit price	(\$20.00)	Press NB to temporarily finalize the transaction.	CLERK 01 000039
	Quantity	1		OLDCHK 1234 — Check No.
	Dept.	2		ST .15.00 — Previous balance
(): Preset value			- 2	DEPT02 .20.00
			NB	SRVC TL .35.00

Closing a check

OPERATION

RECEIPT

Check number	1234
Payment Cash	\$40.00

If necessary, press to issue the guest receipt.

REG 15-03-2002 13:35	
CLERK 01	000040
OLDCHK	1234
ST	.35.00
TOTAL	.35.00
CASH	.40.00
CHANGE	.5.00

REG 15-03-2002 13:35	
CLERK 01	000038
CHK-#	1234
DEPT04	.10.00
PLU0032	.5.00
DEPT02	.20.00
TOTAL	.35.00
CASH	.40.00
CHANGE	.5.00

The program controlling check tracking specifications

Compulsory to enter check number before registration	a	No = 0 Yes = 1	a+b = <input type="text"/> D ₇
Compulsory to issue guest receipt	b	No = 0 Yes = 4	a+b = <input type="text"/> D ₆
Tax calculation and printing for <input type="button" value="NB"/> finalization	a	No = 0 Yes = 1	
Prohibit to open the check number made by another clerk	b	No = 0 Yes = 4	<input type="text"/> 0 ~ <input type="text"/> 0 D ₅ ~ D ₁
Always "00000"			

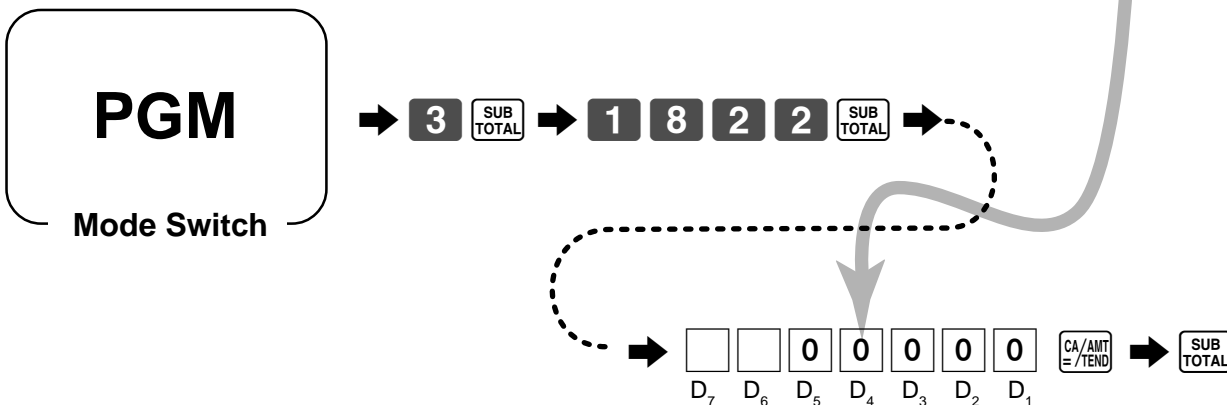

Convenient Operations and Setups

The program for new balance key

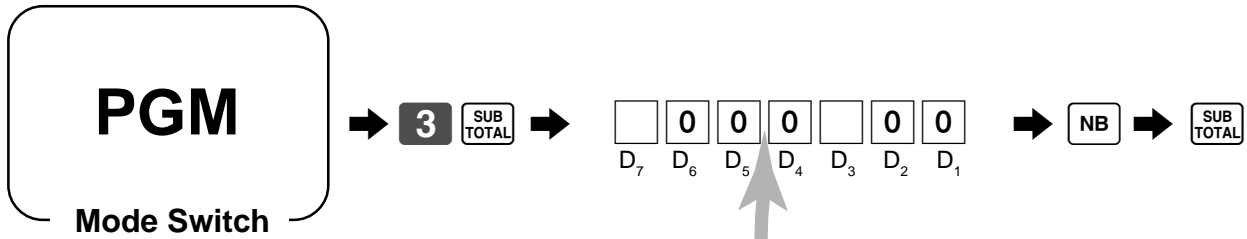

Auto-cash function: a function is activated when a check is not opened.	No = 0 Yes = 2	<input type="checkbox"/> D_7
Always "000"		<input type="checkbox"/> 0 ~ <input type="checkbox"/> 0 $D_6 \sim D_4$
Print VAT breakdown.	No = 0 Yes = 1	<input type="checkbox"/> D_3
Always "00"		<input type="checkbox"/> 0 <input type="checkbox"/> 0 $D_2 D_1$

How to program set menu

Programming set menu includes two steps;

- ① Assigning PLUs and flat-PLUs to set menu tables. (These items are treated as “child” PLU.)
- ② Assigning set menu tables to “parent” PLU
(When a “parent” PLU is registered, all “child” PLUs in the designated set menu table are registered.)

Programming set menu table

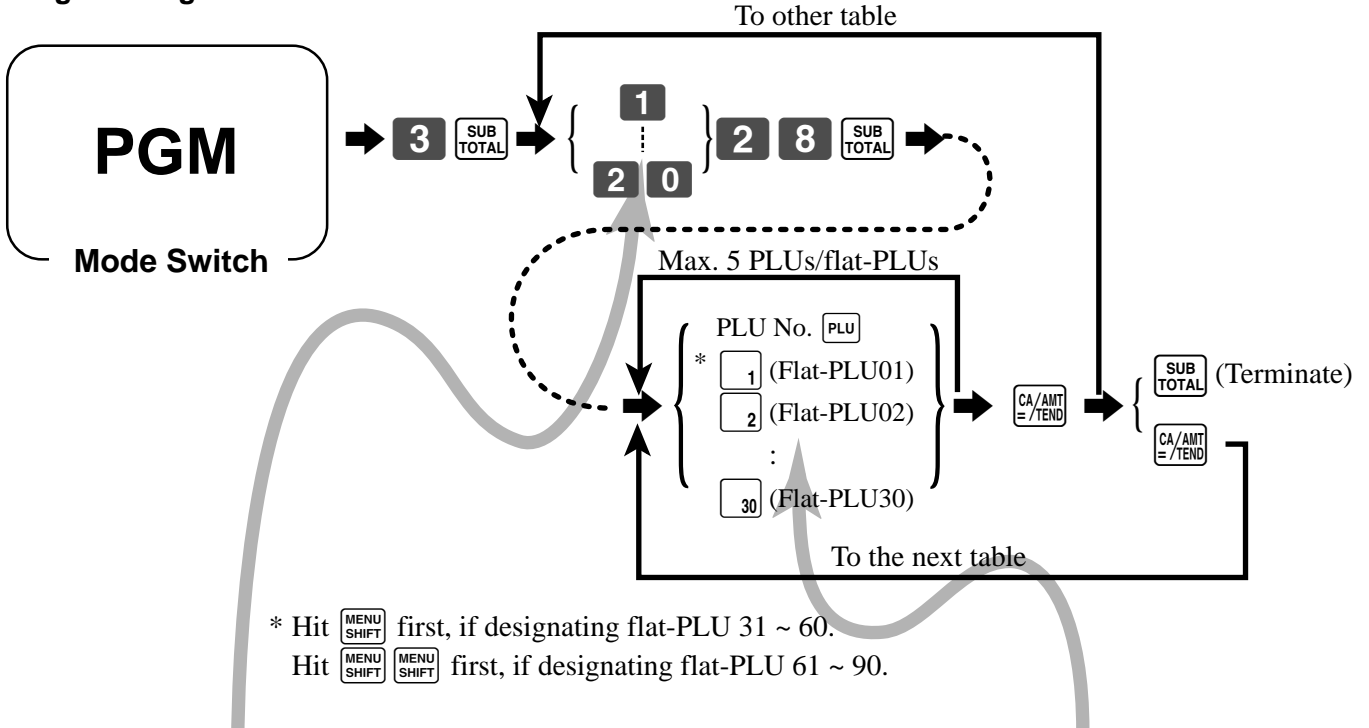

Memory No.	Program code	Contents	PLU/flat PLU			
01	28	Set menu 1				
02		Set menu 2				
03		Set menu 3				
04		Set menu 4				
05		Set menu 5				
06		Set menu 6				
07		Set menu 7				
08		Set menu 8				
09		Set menu 9				
10		Set menu 10				
11		Set menu 11				
12		Set menu 12				
13		Set menu 13				
14		Set menu 14				
15		Set menu 15				
16		Set menu 16				
17		Set menu 17				
18		Set menu 18				
19		Set menu 19				
20		Set menu 20				

Convenient Operations and Setups

Programming assignment to "parent" PLU

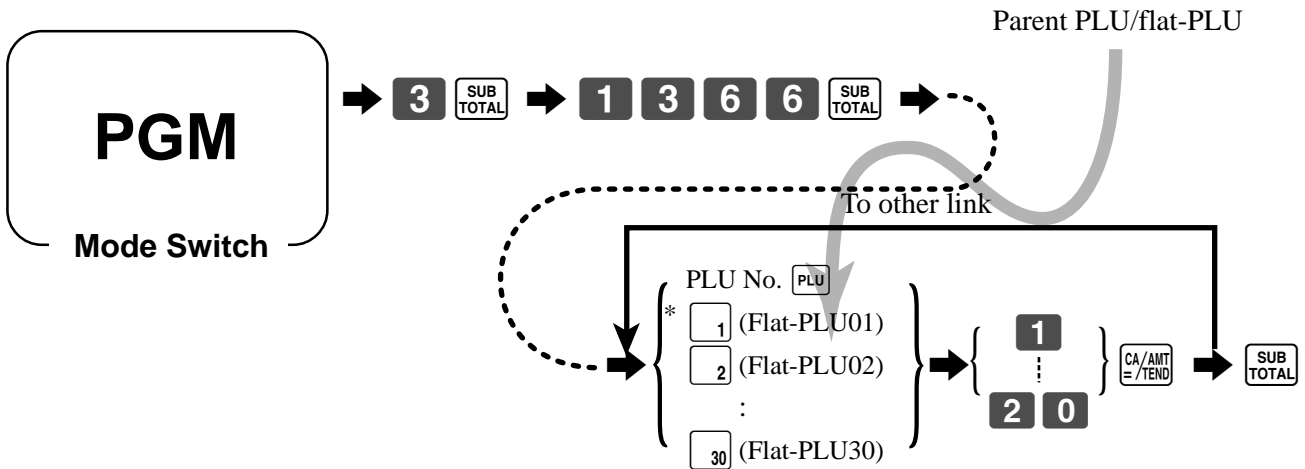

- * Hit **[MENU SHIFT]** first, if designating flat-PLU 31 ~ 60.
- Hit **[MENU SHIFT]** **[MENU SHIFT]** first, if designating flat-PLU 61 ~ 90.

How to program the condiment PLU and preparation PLU

See page 61 ~ 64 for programming.

To program a preparation PLU, set both the condiment flag and the hash flag.

Registering examples

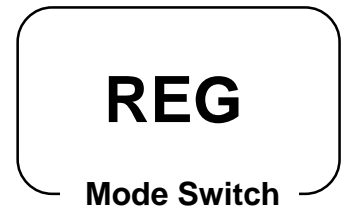

OPERATION

RECEIPT

Main item	PLU 1	\$10.00
Condiment	PLU 11	\$0.10
	PLU 12	\$0.20
	PLU 13	\$0.30
Main item	PLU 20	\$20.00
Preparation	PLU 21	\$0.00
	PLU 22	\$0.00
	PLU 23	\$0.00
Payment	Cash	\$30.60

1 [PLU]
1 1 [PLU]
1 2 [PLU]
1 3 [PLU]
2 0 [PLU]
2 1 [PLU]
2 2 [PLU]
2 3 [PLU]
[SUB TOTAL]

```
REG 15-03-2002 13:40
CLERK 01 000040
PLU0001 .10.00
PLU0011 .0.10
PLU0012 .0.20
PLU0013 .0.30
PLU0020 .20.00
PLU0021
PLU0022
PLU0023
TOTAL .30.60
CASH .30.60
CHANGE .0.00
```

3 0 6 0 [CA/AMT =/TEND]

The operations in the "Arrangement" key programming

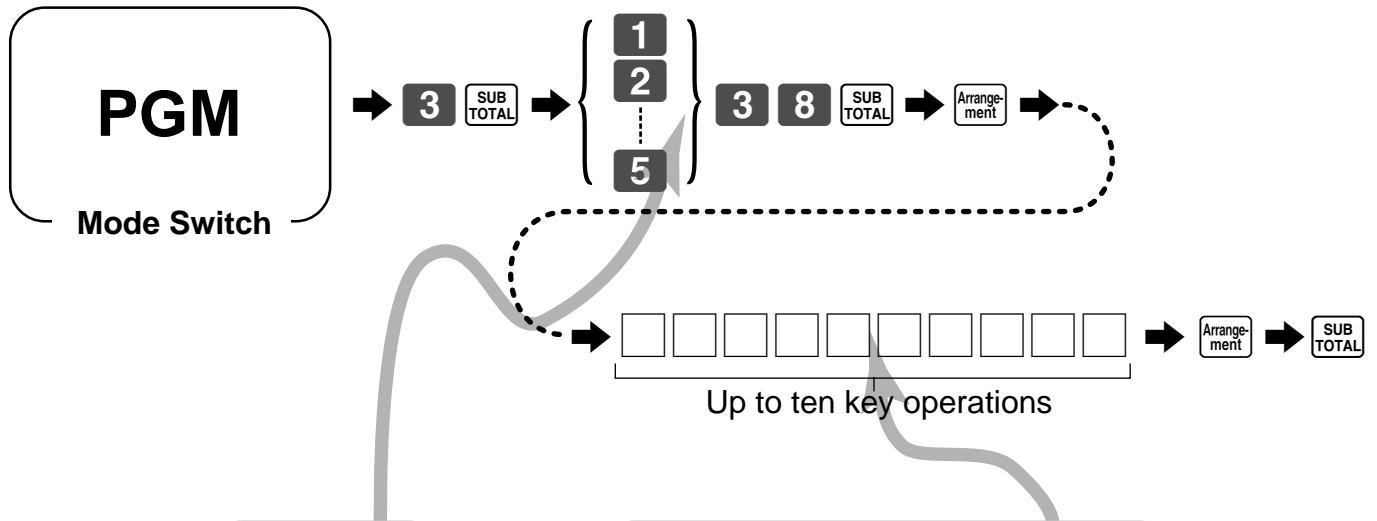

Memory No.	Program code	Arrangement table No.	Key sequence											
01	38	1												
02		2												
03		3												
04		4												
05		5												

Registering examples

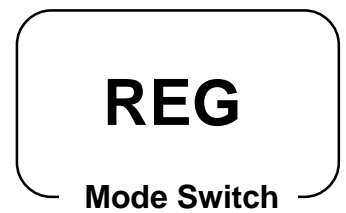

OPERATION

Arrangement		
Item 1	Unit price	\$10.00
	Quantity	1
	Dept.	4
Item 2	Unit price	\$5.00
	Quantity	1
	PLU	32
Payment	Cash	\$15.00

1 5 00 **CA/AMT =/TEND**

Arrangement
SUB TOTAL

REG 15-03-2002 13:45
CLERK 01 000041
DEPT04 .10.00
PLU0032 .5.00
TOTAL .15.00
CASH .15.00
CHANGE .0.00

RECEIPT

Other function key feature programming

You can define a selection of features for the function keys by specifying an 8-digit program code for each key.

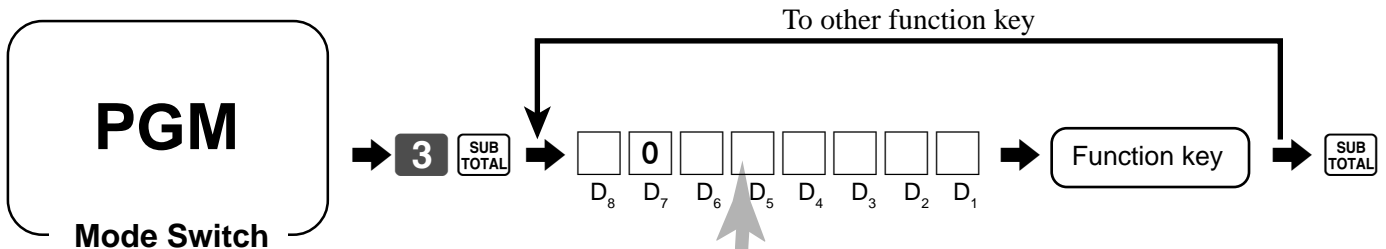

Cash, Charge, Check, Credit key

Restrict (to 0, 5) on the last digit for amount tendered (except <small>CA/AMT = TEND</small>) (only for Australia)	No = 0 Yes = 1	<input type="text"/> D ₈
Always "0"		<input type="text" value="0"/> D ₇
High amount limit specification for subtotal and tendering amounts *1	Maximum value (0 ~ 9)	<input type="text"/> <input type="text"/> D ₆ D ₅
	Number of zeros (0 ~ 9)	
Prohibit entry of a partial payment	a No = 0 Yes = 1	a+b+c = <input type="text"/> D ₄
Prohibit the entry of the amount tendered.	b No = 0 Yes = 2	
Force entry of the amount tendered.	c No = 0 Yes = 4	
Print VAT breakdown.	a No = 0 Yes = 1	a+b = <input type="text"/> D ₃
Restriction (to 00, 25, 50, 75) on last two digits for amount tendered *2	b No = 0 Yes = 4	
High amount limit specification for change amount due. *1	Maximum value (0 ~ 9)	<input type="text"/> <input type="text"/> D ₂ D ₁
	Number of zeros (0 ~ 9)	

*1 High amounts limits:

High amount limitations are specified as 2-digits. The first digit you specify limits the maximum value of the leftmost digit of the value within the range of 0 through 9. The second digit you specify indicates the number of zeros in the limit value, again within the range of 0 through 9.

Example: \$600.00 maximum ⇨ Enter 64.

Entering "00" clears the limitation.

*2 Always program "Restrict = 4" here for cash amount tendered key when you are using Danish rounding.

Received on account, Payout key

Always "00"		<input type="text" value="0"/> <input type="text" value="0"/> D ₈ D ₇
High amount limit specification for change amount due. (refer to *1 on the previous page.)	Maximum value (0 ~ 9)	<input type="text"/> <input type="text"/> D ₆ D ₅
	Number of zeros (0 ~ 9)	
Always "0000"		<input type="text" value="0"/> ~ <input type="text" value="0"/> D ₄ ~ D ₁

Minus, Plus key

Always "00"		<input type="text" value="0"/> <input type="text" value="0"/> D ₈ D ₇
Allow credit balance. (<input type="text" value="-"/> only) Allow registration outside of a sale. (<input type="text" value="Plus"/> only)	No = 0 Yes = 1	<input type="text"/> D ₆
	High digit limit specification	Significant number <input type="text"/> D ₅
Taxable status 1	a No = 0 Yes = 1	a+b+c = <input type="text"/> D ₄
Taxable status 2	b No = 0 Yes = 2	
Taxable status 3	c No = 0 Yes = 4	
Commission 1	a No = 0 Yes = 1	a+b+c = <input type="text"/> D ₃
Commission 2	b No = 0 Yes = 2	
Taxable status 4	c No = 0 Yes = 4	
Always "00"		<input type="text" value="0"/> <input type="text" value="0"/> D ₂ D ₁

#/No sale key

Always "00"		<input type="text" value="0"/> <input type="text" value="0"/> D ₈ D ₇
Treat as the first transaction.	No = 0 Yes = 1	<input type="text"/> D ₆
Always "00000"		<input type="text" value="0"/> ~ <input type="text" value="0"/> D ₅ ~ D ₁

Tax shift key

Always "0000"		<input type="text" value="0"/> ~ <input type="text" value="0"/> D ₈ ~ D ₅
Taxable status 0 ~ 4; Taxable 1 = 0/1 Taxable 2 = 2, Taxable 3 = 3, Taxable 4 = 4	Significant number	<input type="text"/> D ₄
Always "000"		<input type="text" value="0"/> ~ <input type="text" value="0"/> D ₃ ~ D ₁

Convenient Operations and Setups

Calculator functions

While registering at the REG mode, you can switch to CAL mode and then return to REG mode to resume the registration.

CAL

Mode Switch

Example 1 (Calculation examples)

	OPERATION	DISPLAY
Clear		0
5+3-2=		6
(23-56)×78=		-2574
12 % on 1500		180

Example 2 (Memory recall)

Item 1	Unit price	\$10.00
	Quantity	1
	Dept.	1
Item 2	Unit price	\$20.00
	Quantity	1
	Dept.	2
Payment	Cash	\$10.00
	by 3 persons each,	

OPERATION	DISPLAY/RECEIPT
<p>Turn to REG</p>	
<p>Turn to CAL</p>	
<p>Memory recall: Recalls subtotal amount</p> <p>Divides the subtotal by 3 persons</p>	
<p>Turn to REG</p>	
<p>Memory recall: Recalls the result amount</p>	

Programming calculator mode control

Open drawer when $\boxed{\text{CA/AMT}=\text{TEND}}$ (equal) is pressed in CAL mode.	a	No = 0 Yes = 1	a+b+c = $\boxed{}$ D ₅
Open drawer when $\boxed{\#/\text{NS}}$ is pressed in CAL mode.	b	No = 0 Yes = 2	
Print calculator total on the daily report.	c	Yes = 0 No = 4	
Always "0000"			$\boxed{0} \sim \boxed{0}$ D ₄ ~ D ₁

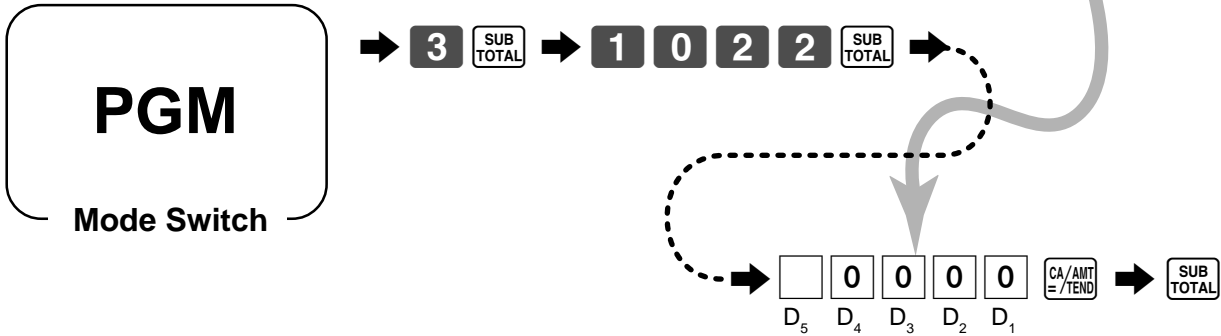

About the daylight saving time

It is possible to set the internal clock forward/backward by 1 ~ 9 hour(s) for the daylight saving time.

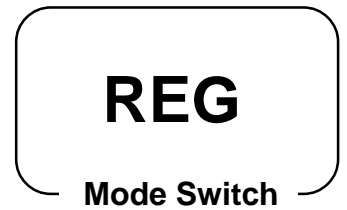

OPERATION

DISPLAY

• Forward by 1 hour

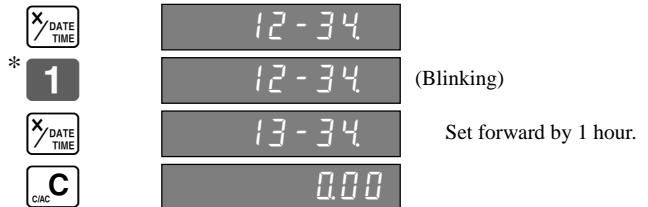

• Backward by 1 hour

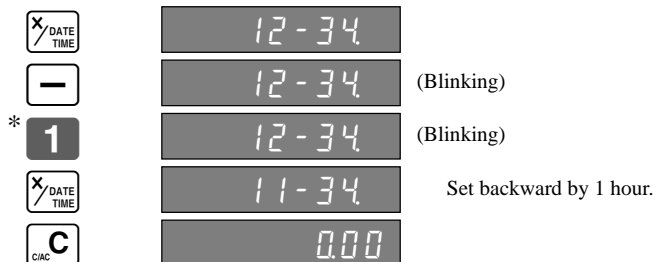

* Put 2 ~ 9, in case of set the clock by 2 ~ 9 hours.

Keyboard layout change

You can change the keyboard layout or allocate some new functions on the keyboard.

Note: Before changing the keyboard layout, you must issue the daily and periodic reset reports.

Configuration of the physical key layout

The shadowed keys are fixed function keys. You cannot change the function of these keys.

#068	#-63	#-58	#-53	#-48	#-43	#-38	#-33	C	#-28	#-27	#-26	FEED	#-18
#-67	#-62	#-57	#-52	#-47	#-42	#-37	#-32	7	8	9	#-25	#-20	#-17
#-66	#-61	#-56	#-51	#-46	#-41	#-36	#-31	4	5	6	#-24	#-19	#-16
#-65	#-60	#-55	#-50	#-45	#-40	#-35	#-30	1	2	3	#-23	SUB TOTAL	#-15
#-64	#-59	#-54	#-49	#-44	#-39	#-34	#-29	0	#-11	#-12	#-22	#-13	

Note: The  key in programming procedures mean the #-13 key on the keyboard.

Programming the function of each key

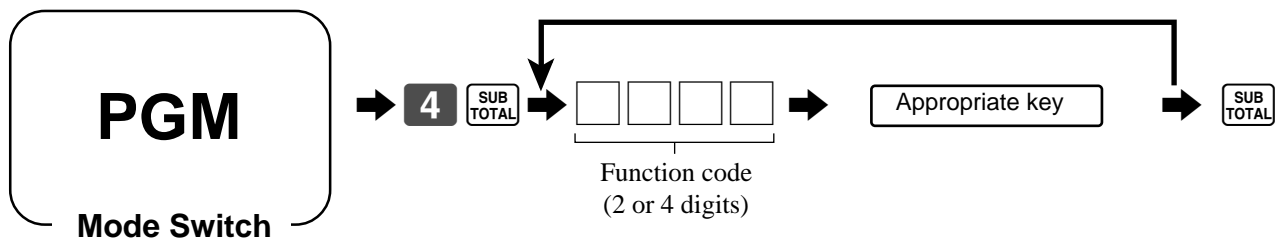

Content	Function code	Content	Function code	Content	Function code
Cash/amount tendered	01	Post receipt/guest receipt	38	Open	67
Charge	02	Non-add	40	Preset open	68
Check	03	Non-add/no sale	41	Open/clerk No.	69
Credit	04	No sale	42	Add/price	70
New balance	06	No. of customer	43	Clerk No.	72
Recall character	10	Arrangement	44	Subtotal	75
Tip	15	Currency exchange	45	Receipt on/off	76
Received on account	20	VAT	46	Multiplication/date time	82
Paid out	21	Price	49	Paid out/VAT	89
Minus	27	PLU	50	New check	91
Discount	28	Department 1	0151	Old check	92
Plus	29	Department 2	0251	New/old check	93
Premium	30	:	:	Add check	94
Manual tax	32	Department 8	0851	No function	00
Refund	33	Tax shift	57	"00" double zero	96
Error correct/cancel	34	Flat PLU	63	"000" triple zero	97
Void	35	Menu shift	64	"." decimal point	98

Note: Two zero key, three zero key, decimal point key can only be allocated in #-11 and #-12 position.

The outline of the functions

- **Cash/amount tendered:**
This key is used to register a cash amount due either with or without a tendered amount input.
- **Charge:**
This key registers a charge sale.
- **Check:**
This key is used to register a check payment amount either with or without a tendered amount input.
- **Credit:**
This key registers a credit sale.
- **New balance:**
This key adds latest registered total to the previous balance to obtain a new balance.
- **Recall character:**
This key is used to print programmed text messages.
- **Tip:**
This key registers tips.
- **Received on account:**
This key registers a received on account amount.
- **Paid out:**
This key registers an amount paid out from the register.
- **Minus:**
This key registers an amount for subtraction.
- **Discount:**
This key applies a preset or manually input percent rate to obtain the discount amount for the last registered item or subtotal.
- **Plus:**
This key registers an amount for addition.
- **Premium:**
This key applies a preset or manually input percent rate to obtain the premium amount for the last registered item or subtotal.
- **Manual tax:**
This key is used to register manually entered tax.
- **Refund:**
This key declares next input a return or cancels the last registered item in a transaction.
- **Error correct/Cancel:**
This key corrects registration errors or cancels entire registrations of current transaction.
- **Void:**
This key invalidates preceding data registered for departments, PLUs or flat-PLUs.
This key must be pressed before the transaction involving the data to be invalidated is finalized, but is also effective even after calculation of a subtotal amount.
- **Post receipt/Guest receipt:**
After finalization, this key produces a post receipt.
After designating a check number, this key produces a guest receipt.
- **Non-add, No sale:**
Non-add; These keys print reference numbers during transaction.
No sale; These keys open the drawer between the transactions.
- **Number of customers:**
This key is used to enter the number of customers.
- **Arrangement:**
Executes the multiple operations assigned.
- **Currency exchange:**
This key calculates subtotal amounts or paying amount dues in foreign currency.
- **VAT:**
This key prints a VAT breakdown.
- **Price:**
Use this key to register unit prices for subdepartment.
- **PLU:**
Use this key to input PLU (subdepartment) numbers.
- **Department:**
Use these keys to register items to departments.
- **Tax shift:**
This key changes the tax status of the next item.
It is necessary to assign the tax status of this key.
- **Flat-PLU:**
Use these keys to register items to flat-PLUs.
- **Menu shift:**
This key shifts flat-PLU key from 1st to 2nd, 2nd to 3rd or 3rd to 1st.
- **Open:**
This key releases maximum digit limit.
- **Preset open:**
This key suspends compulsory specifications.
- **Clerk number:**
This key assigns clerk numbers.
- **Subtotal:**
This key obtains subtotal including the add-on tax and the previous balance.
- **Multiplication/Date•time:**
This key is used to input quantities for multiple items with the same price.
This key also displays the time or date between transactions.
- **New check:**
This key is used in a check tracking system to input a new check number in order to open a new check under that number.
- **Old check:**
This key is used in a check tracking system to input the number of an existing check whose details are stored in a check tracking memory. Existing checks are reopened to perform further registration or to finalize them.
- **New/Old check:**
This key is used in a check tracking system to input check numbers in order to open new checks and to reopen existing checks. When the clerk inputs a check number, the register checks to see if that number already exists in the check tracking memory. If there is no match number in memory, a new check is opened under the input number. If the check number already stored in memory, that check is reopened for further registration or finalization.
- **Add check:**
This key is used in check tracking system to combine the details of more than one check into a single check.

Printing read/reset reports

- **Read report**

You can print read reports at any time during the business day without affecting the data stored in the cash register's memory.

- **Reset report**

You should print reset reports at the end of the business day.

Important!

- The reset operation issues a report and also clears all sales data from the cash register's memory.
- Be sure to perform the reset operations at the end of each business day. Otherwise, you will not be able to distinguish between the sales data for different dates.

To print the individual department, PLU/subdepartment read report

This report shows sales for specific departments or PLU/subdepartments.

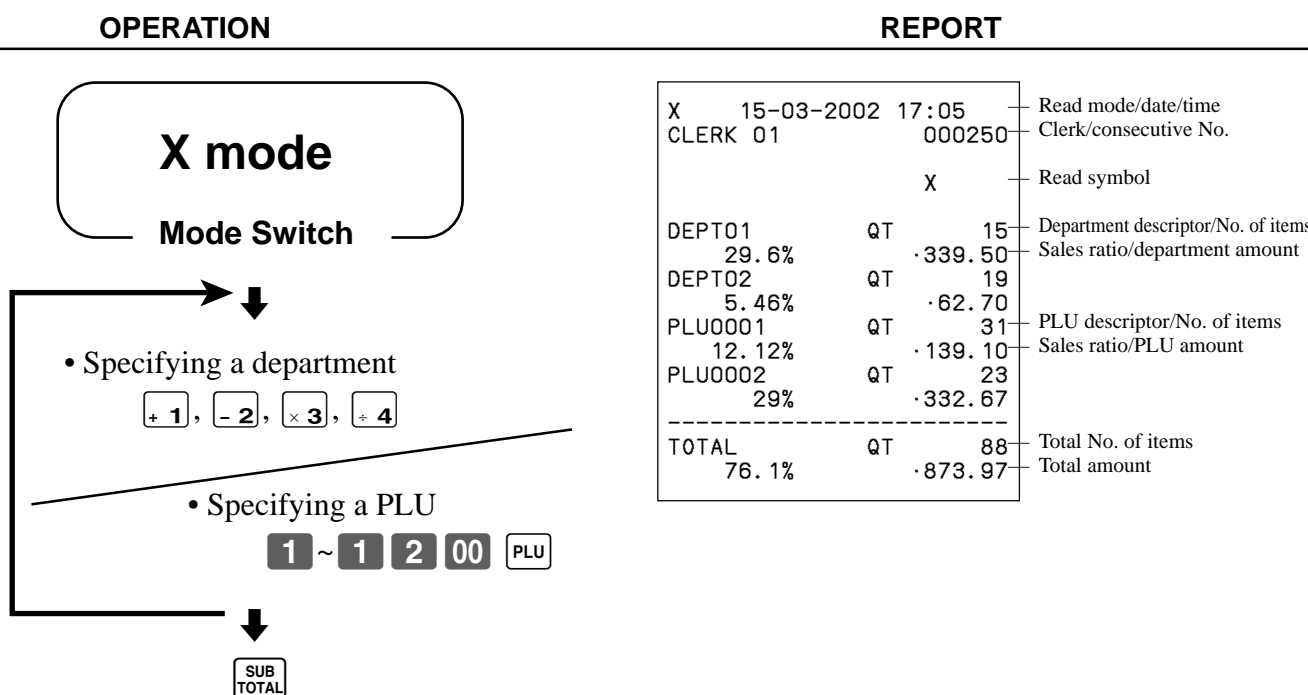

After you finish to select departments, PLU/subdepartments, press SUB TOTAL to terminate.

To print the financial read report

This report shows gross sales, net sales, cash in drawer and check in drawer.

OPERATION	REPORT																																																
<div style="border: 1px solid black; border-radius: 15px; padding: 10px; width: fit-content; margin: 0 auto;"> <p>X mode</p> </div> <p>Mode Switch</p> <p style="text-align: center;">↓</p> <p>Money declaration *1</p> <p>(Cash in drawer amount # / NS)</p> <p style="text-align: center;">↓</p> <div style="border: 1px solid black; padding: 2px; display: inline-block;"> X / DATE / TIME </div>	<table border="1" style="width: 100%; border-collapse: collapse;"> <tr> <td>X</td> <td>15-03-2002</td> <td>17:10</td> <td>Read mode/date/time</td> </tr> <tr> <td>CLERK</td> <td>01</td> <td>000251</td> <td>Clerk/consecutive No.</td> </tr> <tr> <td colspan="3" style="text-align: center;">FLASH X</td> <td>Report title/read symbol</td> </tr> <tr> <td>GROSS TOTAL</td> <td>QT</td> <td>1216</td> <td>Gross No. of items</td> </tr> <tr> <td></td> <td></td> <td>·21954.50</td> <td>Gross amount</td> </tr> <tr> <td>NET TOTAL</td> <td>No</td> <td>523</td> <td>Net No. of customers</td> </tr> <tr> <td></td> <td></td> <td>·27733.12</td> <td>Net amount</td> </tr> <tr> <td>CASH-INDW</td> <td></td> <td>·27289.10</td> <td>Cash in drawer (b)</td> </tr> <tr> <td>#</td> <td></td> <td>·27270.00</td> <td>Declared amount (a)</td> </tr> <tr> <td></td> <td></td> <td>·19.10</td> <td>Difference (b) - (a)</td> </tr> <tr> <td>CHECK-INDW</td> <td></td> <td>·332.67</td> <td>Check in drawer</td> </tr> <tr> <td>CREDIT-INDW</td> <td></td> <td>·398.00</td> <td>Credit in drawer</td> </tr> </table>	X	15-03-2002	17:10	Read mode/date/time	CLERK	01	000251	Clerk/consecutive No.	FLASH X			Report title/read symbol	GROSS TOTAL	QT	1216	Gross No. of items			·21954.50	Gross amount	NET TOTAL	No	523	Net No. of customers			·27733.12	Net amount	CASH-INDW		·27289.10	Cash in drawer (b)	#		·27270.00	Declared amount (a)			·19.10	Difference (b) - (a)	CHECK-INDW		·332.67	Check in drawer	CREDIT-INDW		·398.00	Credit in drawer
X	15-03-2002	17:10	Read mode/date/time																																														
CLERK	01	000251	Clerk/consecutive No.																																														
FLASH X			Report title/read symbol																																														
GROSS TOTAL	QT	1216	Gross No. of items																																														
		·21954.50	Gross amount																																														
NET TOTAL	No	523	Net No. of customers																																														
		·27733.12	Net amount																																														
CASH-INDW		·27289.10	Cash in drawer (b)																																														
#		·27270.00	Declared amount (a)																																														
		·19.10	Difference (b) - (a)																																														
CHECK-INDW		·332.67	Check in drawer																																														
CREDIT-INDW		·398.00	Credit in drawer																																														

*1 Money declaration:

Count how much cash is in the drawer and input this amount (up to 8-digits).

The cash register will automatically compare the input with the cash in drawer in the memory and print the difference between these two amounts.

Note that if money declaration is required by programming (page 47), you cannot skip this procedure.

To print the group read report

This report shows group totals.

OPERATION	REPORT																																																								
<div style="border: 1px solid black; border-radius: 15px; padding: 10px; width: fit-content; margin: 0 auto;"> <p>X mode</p> </div> <p>Mode Switch</p> <p style="text-align: center;">↓</p> <div style="display: flex; align-items: center; gap: 5px;"> <div style="border: 1px solid black; padding: 2px 5px; font-weight: bold; font-size: 1.2em;">6</div> <div style="border: 1px solid black; padding: 2px; font-size: 0.8em;">CA/AMT =/TEND</div> </div>	<table border="1" style="width: 100%; border-collapse: collapse;"> <tr> <td>X</td> <td>15-03-2002</td> <td>17:15</td> <td>Read mode/date/time</td> </tr> <tr> <td>CLERK</td> <td>01</td> <td>000252</td> <td>Clerk/consecutive No.</td> </tr> <tr> <td>0006</td> <td>GROUP</td> <td>X</td> <td>Report code/report title/read symbol</td> </tr> <tr> <td>01</td> <td>.....</td> <td>QT 16</td> <td>Group 01/No. of items</td> </tr> <tr> <td></td> <td>0.24%</td> <td>·54.50</td> <td>Sales ratio/group 01 amount</td> </tr> <tr> <td>02</td> <td>.....</td> <td>QT 25</td> <td></td> </tr> <tr> <td></td> <td>0.09%</td> <td>·21.33</td> <td></td> </tr> <tr> <td>03</td> <td>.....</td> <td>QT 132</td> <td></td> </tr> <tr> <td></td> <td>0.12%</td> <td>·90.78</td> <td></td> </tr> <tr> <td>.....</td> <td>.....</td> <td>QT 6</td> <td>Total of non-group link PLUs</td> </tr> <tr> <td></td> <td>0.02%</td> <td>·4.50</td> <td></td> </tr> <tr> <td colspan="4" style="border-top: 1px dashed black;"></td> </tr> <tr> <td>TOTAL</td> <td></td> <td>QT 156</td> <td>Total No. of items</td> </tr> <tr> <td></td> <td>0.47%</td> <td>·332.67</td> <td>Total amount</td> </tr> </table>	X	15-03-2002	17:15	Read mode/date/time	CLERK	01	000252	Clerk/consecutive No.	0006	GROUP	X	Report code/report title/read symbol	01	QT 16	Group 01/No. of items		0.24%	·54.50	Sales ratio/group 01 amount	02	QT 25			0.09%	·21.33		03	QT 132			0.12%	·90.78		QT 6	Total of non-group link PLUs		0.02%	·4.50						TOTAL		QT 156	Total No. of items		0.47%	·332.67	Total amount
X	15-03-2002	17:15	Read mode/date/time																																																						
CLERK	01	000252	Clerk/consecutive No.																																																						
0006	GROUP	X	Report code/report title/read symbol																																																						
01	QT 16	Group 01/No. of items																																																						
	0.24%	·54.50	Sales ratio/group 01 amount																																																						
02	QT 25																																																							
	0.09%	·21.33																																																							
03	QT 132																																																							
	0.12%	·90.78																																																							
.....	QT 6	Total of non-group link PLUs																																																						
	0.02%	·4.50																																																							
TOTAL		QT 156	Total No. of items																																																						
	0.47%	·332.67	Total amount																																																						

Issue this report before the PLU reset report, otherwise the group totals are all reset.

Convenient Operations and Setups

To print the PLU/subdepartment/flat-PLU read/reset report

This report shows sales for PLUs/subdepartments/flat-PLUs.

OPERATION	REPORT																																																								
<div style="border: 1px solid black; border-radius: 15px; padding: 10px; width: fit-content; margin: 0 auto;"> <p>Read: X mode</p> <p>Reset: Z mode</p> <p>Mode Switch</p> <p style="text-align: center;">↓</p> <div style="display: flex; align-items: center; justify-content: center;"> <div style="border: 1px solid black; padding: 2px 5px; margin-right: 5px;">1</div> <div style="border: 1px solid black; padding: 2px 5px; margin-right: 5px;">CA/AMT</div> <div style="border: 1px solid black; padding: 2px 5px;">=/TEND</div> </div> </div>	<table border="1" style="width: 100%; border-collapse: collapse;"> <tr> <td>Z</td> <td>15-03-2002</td> <td>17:25</td> <td>Reset mode/date/time</td> </tr> <tr> <td>CLERK</td> <td>01</td> <td>000254</td> <td>Clerk/consecutive No.</td> </tr> <tr> <td>0001</td> <td>PLU</td> <td>Z 0001</td> <td>Report code/report title/reset symbol/reset counter</td> </tr> <tr> <td>PLU0001</td> <td>QT</td> <td>16</td> <td>PLU001/No. of items</td> </tr> <tr> <td>0.24%</td> <td></td> <td>·54.50</td> <td>Sales ratio/PLU001 amount</td> </tr> <tr> <td>PLU0002</td> <td>QT</td> <td>25</td> <td></td> </tr> <tr> <td>0.09%</td> <td></td> <td>·21.33</td> <td></td> </tr> <tr> <td>PLU0003</td> <td>QT</td> <td>132</td> <td></td> </tr> <tr> <td>0.12%</td> <td></td> <td>·90.78</td> <td></td> </tr> <tr> <td>PLU0400</td> <td>QT</td> <td>0</td> <td></td> </tr> <tr> <td>0.02%</td> <td></td> <td>·4.50</td> <td></td> </tr> <tr> <td colspan="3" style="border-top: 1px dashed black;"></td> <td></td> </tr> <tr> <td>TOTAL</td> <td>QT</td> <td>156</td> <td>Total No. of items</td> </tr> <tr> <td>100%</td> <td></td> <td>·21960.90</td> <td>Total amount</td> </tr> </table>	Z	15-03-2002	17:25	Reset mode/date/time	CLERK	01	000254	Clerk/consecutive No.	0001	PLU	Z 0001	Report code/report title/reset symbol/reset counter	PLU0001	QT	16	PLU001/No. of items	0.24%		·54.50	Sales ratio/PLU001 amount	PLU0002	QT	25		0.09%		·21.33		PLU0003	QT	132		0.12%		·90.78		PLU0400	QT	0		0.02%		·4.50						TOTAL	QT	156	Total No. of items	100%		·21960.90	Total amount
Z	15-03-2002	17:25	Reset mode/date/time																																																						
CLERK	01	000254	Clerk/consecutive No.																																																						
0001	PLU	Z 0001	Report code/report title/reset symbol/reset counter																																																						
PLU0001	QT	16	PLU001/No. of items																																																						
0.24%		·54.50	Sales ratio/PLU001 amount																																																						
PLU0002	QT	25																																																							
0.09%		·21.33																																																							
PLU0003	QT	132																																																							
0.12%		·90.78																																																							
PLU0400	QT	0																																																							
0.02%		·4.50																																																							
TOTAL	QT	156	Total No. of items																																																						
100%		·21960.90	Total amount																																																						

To print the hourly sales read/reset report

This report shows hourly breakdowns of sales.

OPERATION	REPORT																																																								
<div style="border: 1px solid black; border-radius: 15px; padding: 10px; width: fit-content; margin: 0 auto;"> <p>Read: X mode</p> <p>Reset: Z mode</p> <p>Mode Switch</p> <p style="text-align: center;">↓</p> <div style="display: flex; align-items: center; justify-content: center;"> <div style="border: 1px solid black; padding: 2px 5px; margin-right: 5px;">2</div> <div style="border: 1px solid black; padding: 2px 5px; margin-right: 5px;">CA/AMT</div> <div style="border: 1px solid black; padding: 2px 5px;">=/TEND</div> </div> </div>	<table border="1" style="width: 100%; border-collapse: collapse;"> <tr> <td>Z</td> <td>15-03-2002</td> <td>17:30</td> <td>Reset mode/date/time</td> </tr> <tr> <td>CLERK</td> <td>01</td> <td>000255</td> <td>Clerk/consecutive No.</td> </tr> <tr> <td>0002</td> <td>HOURLY</td> <td>Z 0001</td> <td>Report code/report title/reset symbol/reset counter</td> </tr> <tr> <td>00:00-01:00</td> <td>No</td> <td>6</td> <td>Time range/No. of customers</td> </tr> <tr> <td></td> <td></td> <td>·4.50</td> <td>Sales amount</td> </tr> <tr> <td>01:00-02:00</td> <td>No</td> <td>25</td> <td></td> </tr> <tr> <td></td> <td></td> <td>·21.33</td> <td></td> </tr> <tr> <td>02:00-03:00</td> <td>No</td> <td>132</td> <td></td> </tr> <tr> <td></td> <td></td> <td>·90.78</td> <td></td> </tr> <tr> <td>23:00-24:00</td> <td>No</td> <td>1</td> <td></td> </tr> <tr> <td></td> <td></td> <td>·1.50</td> <td></td> </tr> <tr> <td colspan="3" style="border-top: 1px dashed black;"></td> <td></td> </tr> <tr> <td>TOTAL</td> <td>No</td> <td>56</td> <td>Total No. of customers</td> </tr> <tr> <td></td> <td></td> <td>·1338.40</td> <td>Total amount</td> </tr> </table>	Z	15-03-2002	17:30	Reset mode/date/time	CLERK	01	000255	Clerk/consecutive No.	0002	HOURLY	Z 0001	Report code/report title/reset symbol/reset counter	00:00-01:00	No	6	Time range/No. of customers			·4.50	Sales amount	01:00-02:00	No	25				·21.33		02:00-03:00	No	132				·90.78		23:00-24:00	No	1				·1.50						TOTAL	No	56	Total No. of customers			·1338.40	Total amount
Z	15-03-2002	17:30	Reset mode/date/time																																																						
CLERK	01	000255	Clerk/consecutive No.																																																						
0002	HOURLY	Z 0001	Report code/report title/reset symbol/reset counter																																																						
00:00-01:00	No	6	Time range/No. of customers																																																						
		·4.50	Sales amount																																																						
01:00-02:00	No	25																																																							
		·21.33																																																							
02:00-03:00	No	132																																																							
		·90.78																																																							
23:00-24:00	No	1																																																							
		·1.50																																																							
TOTAL	No	56	Total No. of customers																																																						
		·1338.40	Total amount																																																						

To print the monthly sales read/reset report

This report shows monthly breakdowns of sales.

OPERATION	REPORT																																																																						
<div style="border: 1px solid black; border-radius: 15px; padding: 10px; width: fit-content; margin: 0 auto;"> <p>Read: X mode Reset: Z mode</p> <p>Mode Switch</p> <p style="text-align: center;">↓</p> <div style="display: flex; align-items: center; justify-content: center;"> <div style="border: 1px solid black; padding: 2px 5px; margin-right: 5px;">3</div> <div style="border: 1px solid black; padding: 2px 5px; margin-right: 5px;">CA/AMT</div> <div style="border: 1px solid black; padding: 2px 5px;">=/TEND</div> </div> </div>	<table border="1" style="width: 100%; border-collapse: collapse;"> <tr> <td>Z</td> <td>15-03-2002</td> <td>17:35</td> <td></td> <td>Reset mode/date/time</td> </tr> <tr> <td>CLERK</td> <td>01</td> <td></td> <td>000256</td> <td>Clerk/consecutive No.</td> </tr> <tr> <td>0003</td> <td>MONTHLY</td> <td>Z</td> <td>0001</td> <td>Report code/report title/reset symbol/reset counter</td> </tr> <tr> <td>1</td> <td>...</td> <td>No</td> <td>6</td> <td>Date of a month/No. of customers</td> </tr> <tr> <td></td> <td></td> <td></td> <td>.4.50</td> <td>Sales amount</td> </tr> <tr> <td>2</td> <td>...</td> <td>No</td> <td>25</td> <td></td> </tr> <tr> <td></td> <td></td> <td></td> <td>.21.33</td> <td></td> </tr> <tr> <td>3</td> <td>...</td> <td>No</td> <td>132</td> <td></td> </tr> <tr> <td></td> <td></td> <td></td> <td>.90.78</td> <td></td> </tr> <tr> <td>31</td> <td>...</td> <td>No</td> <td>1</td> <td></td> </tr> <tr> <td></td> <td></td> <td></td> <td>.1.50</td> <td></td> </tr> <tr> <td colspan="4" style="border-top: 1px dashed black;"></td> <td></td> </tr> <tr> <td>TOTAL</td> <td></td> <td>No</td> <td>56</td> <td>Total No. of customers</td> </tr> <tr> <td></td> <td></td> <td></td> <td>.1338.40</td> <td>Total amount</td> </tr> </table>	Z	15-03-2002	17:35		Reset mode/date/time	CLERK	01		000256	Clerk/consecutive No.	0003	MONTHLY	Z	0001	Report code/report title/reset symbol/reset counter	1	...	No	6	Date of a month/No. of customers				.4.50	Sales amount	2	...	No	25					.21.33		3	...	No	132					.90.78		31	...	No	1					.1.50							TOTAL		No	56	Total No. of customers				.1338.40	Total amount
Z	15-03-2002	17:35		Reset mode/date/time																																																																			
CLERK	01		000256	Clerk/consecutive No.																																																																			
0003	MONTHLY	Z	0001	Report code/report title/reset symbol/reset counter																																																																			
1	...	No	6	Date of a month/No. of customers																																																																			
			.4.50	Sales amount																																																																			
2	...	No	25																																																																				
			.21.33																																																																				
3	...	No	132																																																																				
			.90.78																																																																				
31	...	No	1																																																																				
			.1.50																																																																				
TOTAL		No	56	Total No. of customers																																																																			
			.1338.40	Total amount																																																																			

To print the electronic journal memory read/reset report

Even if the printer is used for issuing receipts, you can get transaction logs by this report.

OPERATION	REPORT																																																																																					
<div style="border: 1px solid black; border-radius: 15px; padding: 10px; width: fit-content; margin: 0 auto;"> <p>Read: X mode Reset: Z mode</p> <p>Mode Switch</p> <div style="display: flex; justify-content: space-around; margin-top: 10px;"> <div style="text-align: center;"> <p>↓</p> <div style="display: flex; align-items: center; justify-content: center;"> <div style="border: 1px solid black; padding: 2px 5px; margin-right: 5px;">5</div> <div style="border: 1px solid black; padding: 2px 5px; margin-right: 5px;">8</div> <div style="border: 1px solid black; padding: 2px 5px; margin-right: 5px;">CA/AMT</div> <div style="border: 1px solid black; padding: 2px 5px;">=/TEND</div> </div> <p>↓</p> <div style="border: 1px solid black; padding: 5px; width: 100px; text-align: center;"> <input type="text"/> <input type="text"/> <input type="text"/> <input type="text"/> <input type="text"/> <input type="text"/> </div> <p>(report start date; YYMMDD) If skipped, start with the first record.</p> <p>↓</p> <div style="border: 1px solid black; padding: 2px 5px; margin: 0 auto;">CA/AMT</div> <p>↓</p> <div style="border: 1px solid black; padding: 5px; width: 100px; text-align: center;"> <input type="text"/> <input type="text"/> <input type="text"/> <input type="text"/> <input type="text"/> <input type="text"/> </div> <p>(report start consecutive No.) If skipped, start with the first record.</p> <p>↓</p> <div style="border: 1px solid black; padding: 2px 5px; margin: 0 auto;">CA/AMT</div> <p>↓</p> <div style="border: 1px solid black; padding: 2px 5px; margin: 0 auto;">=/TEND</div> </div> </div> <div style="text-align: center; margin-top: 10px;"> <p>↓</p> <div style="display: flex; align-items: center; justify-content: center;"> <div style="border: 1px solid black; padding: 2px 5px; margin-right: 5px;">5</div> <div style="border: 1px solid black; padding: 2px 5px; margin-right: 5px;">8</div> <div style="border: 1px solid black; padding: 2px 5px; margin-right: 5px;">CA/AMT</div> <div style="border: 1px solid black; padding: 2px 5px;">=/TEND</div> </div> <p>(Memory reset) Z mode only</p> </div> </div>	<table border="1" style="width: 100%; border-collapse: collapse;"> <tr> <td>X</td> <td>15-03-2002</td> <td>17:35</td> <td></td> <td>Read mode/date/time</td> </tr> <tr> <td>CLERK</td> <td>01</td> <td></td> <td>000257</td> <td>Clerk/consecutive No.</td> </tr> <tr> <td>0058</td> <td>E-JOURNAL</td> <td>X</td> <td></td> <td>Report code/report title/read symbol</td> </tr> <tr> <td>REG</td> <td>15-03-2002</td> <td>12:33</td> <td></td> <td></td> </tr> <tr> <td>CLERK</td> <td>01</td> <td></td> <td>000122</td> <td></td> </tr> <tr> <td></td> <td></td> <td></td> <td>.1.00</td> <td></td> </tr> <tr> <td>DEPT01</td> <td></td> <td></td> <td>.00</td> <td></td> </tr> <tr> <td>TAX-AMT</td> <td>1</td> <td></td> <td>.3.00</td> <td>Journal images</td> </tr> <tr> <td>TAX</td> <td>1</td> <td></td> <td>.0.15</td> <td></td> </tr> <tr> <td>CASH</td> <td></td> <td></td> <td>.3.15</td> <td></td> </tr> <tr> <td></td> <td></td> <td>2 No</td> <td></td> <td></td> </tr> <tr> <td>REG</td> <td>15-03-2002</td> <td>12:35</td> <td></td> <td></td> </tr> <tr> <td>CLERK</td> <td>01</td> <td></td> <td>000124</td> <td></td> </tr> <tr> <td>DEPT01</td> <td></td> <td></td> <td>.1.00</td> <td></td> </tr> <tr> <td>DEPT02</td> <td></td> <td></td> <td>.2.00</td> <td></td> </tr> <tr> <td></td> <td></td> <td>5 X</td> <td>@1.00</td> <td></td> </tr> <tr> <td>DEPT03</td> <td></td> <td></td> <td>.5.00</td> <td></td> </tr> </table>	X	15-03-2002	17:35		Read mode/date/time	CLERK	01		000257	Clerk/consecutive No.	0058	E-JOURNAL	X		Report code/report title/read symbol	REG	15-03-2002	12:33			CLERK	01		000122					.1.00		DEPT01			.00		TAX-AMT	1		.3.00	Journal images	TAX	1		.0.15		CASH			.3.15				2 No			REG	15-03-2002	12:35			CLERK	01		000124		DEPT01			.1.00		DEPT02			.2.00				5 X	@1.00		DEPT03			.5.00	
X	15-03-2002	17:35		Read mode/date/time																																																																																		
CLERK	01		000257	Clerk/consecutive No.																																																																																		
0058	E-JOURNAL	X		Report code/report title/read symbol																																																																																		
REG	15-03-2002	12:33																																																																																				
CLERK	01		000122																																																																																			
			.1.00																																																																																			
DEPT01			.00																																																																																			
TAX-AMT	1		.3.00	Journal images																																																																																		
TAX	1		.0.15																																																																																			
CASH			.3.15																																																																																			
		2 No																																																																																				
REG	15-03-2002	12:35																																																																																				
CLERK	01		000124																																																																																			
DEPT01			.1.00																																																																																			
DEPT02			.2.00																																																																																			
		5 X	@1.00																																																																																			
DEPT03			.5.00																																																																																			

- Electronic journal memory near-end and memory full:



Electronic journal memory near end /memory full symbol

Important!

- When the register shows the above sign, issue this read report (if necessary) and reset this memory immediately. (If you do not need this report, enter "4058" instead of "58".)
- Issue this report before the daily sales reset report, otherwise you cannot get this report.

Convenient Operations and Setups

To print the daily sales read/reset report

This report shows sales except for PLUs.

OPERATION	REPORT																																																																																																																																																																																																																																															
<div style="border: 1px solid black; border-radius: 15px; padding: 10px; width: fit-content; margin: 0 auto;"> <p>Read: X mode</p> <p>Reset: Z mode</p> <p>Mode Switch</p> <p style="text-align: center;">↓</p> <p>Money declaration *1</p> <p>(Cash in drawer amount # / NS)</p> <p style="text-align: center;">↓</p> <div style="border: 1px solid black; padding: 2px; display: inline-block;">CA/AMT =/TEND</div> </div>																																																																																																																																																																																																																																																
<table border="1" style="width: 100%; border-collapse: collapse;"> <tr> <td>Z</td> <td>15-03-2002</td> <td>17:20</td> <td>Reset mode/date/time</td> </tr> <tr> <td>CLERK 01</td> <td>000258</td> <td></td> <td>Clerk/consecutive No.</td> </tr> <tr> <td>0000</td> <td>DAILY</td> <td>Z 0001</td> <td>Report code/report title/reset symbol/ reset counter *5</td> </tr> <tr> <td>DEPT01</td> <td>QT</td> <td>1015</td> <td>Department descriptor/No. of items *2</td> </tr> <tr> <td>47.07%</td> <td></td> <td>·10339.50</td> <td>Sales ratio/department amount *2</td> </tr> <tr> <td>DEPT02</td> <td>QT</td> <td>19</td> <td></td> </tr> <tr> <td>31.87%</td> <td></td> <td>·7000.70</td> <td></td> </tr> <tr> <td>DEPT03</td> <td>QT</td> <td>31</td> <td></td> </tr> <tr> <td>18.84%</td> <td></td> <td>·4139.10</td> <td></td> </tr> <tr> <td>DEPT04</td> <td>QT</td> <td>23</td> <td></td> </tr> <tr> <td>1.51%</td> <td></td> <td>·332.67</td> <td></td> </tr> <tr> <td>NON-LINK DPT</td> <td>QT</td> <td>10</td> <td>Non-link department No. of items</td> </tr> <tr> <td>0.43%</td> <td></td> <td>·94.90</td> <td>Non-link department amount</td> </tr> <tr> <td colspan="4">-----</td> </tr> <tr> <td>GROSS TOTAL</td> <td>QT</td> <td>1253</td> <td>Gross No. of items</td> </tr> <tr> <td></td> <td></td> <td>·21960.90</td> <td>Gross sales amount</td> </tr> <tr> <td>NET TOTAL</td> <td>No</td> <td>545</td> <td>No. of customers</td> </tr> <tr> <td></td> <td></td> <td>·30217.63</td> <td>Net sales amount</td> </tr> <tr> <td>CASH-INDW</td> <td></td> <td>·29903.06</td> <td>Cash in drawer amount (b)</td> </tr> <tr> <td>#</td> <td></td> <td>·29903.06</td> <td>Declared amount (a)</td> </tr> <tr> <td></td> <td></td> <td>·0.00</td> <td>Difference (b) - (a)</td> </tr> <tr> <td>CHECK-INDW</td> <td></td> <td>·197.17</td> <td>Check in drawer amount</td> </tr> <tr> <td>CREDIT-INDW</td> <td></td> <td>·183.60</td> <td>Credit in drawer amount</td> </tr> <tr> <td>CE-CASH 1</td> <td></td> <td>¥7,000</td> <td>Foreign currency cash in drawer</td> </tr> <tr> <td>CE-CHECK 1</td> <td></td> <td>¥4,000</td> <td>Foreign currency check in drawer</td> </tr> <tr> <td>TAX-AMT 1</td> <td></td> <td>·732.56</td> <td>Taxable amount 1 *3</td> </tr> </table>	Z	15-03-2002	17:20	Reset mode/date/time	CLERK 01	000258		Clerk/consecutive No.	0000	DAILY	Z 0001	Report code/report title/reset symbol/ reset counter *5	DEPT01	QT	1015	Department descriptor/No. of items *2	47.07%		·10339.50	Sales ratio/department amount *2	DEPT02	QT	19		31.87%		·7000.70		DEPT03	QT	31		18.84%		·4139.10		DEPT04	QT	23		1.51%		·332.67		NON-LINK DPT	QT	10	Non-link department No. of items	0.43%		·94.90	Non-link department amount	-----				GROSS TOTAL	QT	1253	Gross No. of items			·21960.90	Gross sales amount	NET TOTAL	No	545	No. of customers			·30217.63	Net sales amount	CASH-INDW		·29903.06	Cash in drawer amount (b)	#		·29903.06	Declared amount (a)			·0.00	Difference (b) - (a)	CHECK-INDW		·197.17	Check in drawer amount	CREDIT-INDW		·183.60	Credit in drawer amount	CE-CASH 1		¥7,000	Foreign currency cash in drawer	CE-CHECK 1		¥4,000	Foreign currency check in drawer	TAX-AMT 1		·732.56	Taxable amount 1 *3	<table border="1" style="width: 100%; border-collapse: collapse;"> <tr> <td>TAX 1</td> <td>·43.96</td> <td>Tax amount 1 *3</td> </tr> <tr> <td>TAX-AMT 2</td> <td>·409.72</td> <td>Taxable amount 2 *3</td> </tr> <tr> <td>TAX 2</td> <td>·21.55</td> <td>Tax amount 2 *3</td> </tr> <tr> <td>TAX-AMT 3</td> <td>·272.50</td> <td>Taxable amount 3 *3</td> </tr> <tr> <td>TAX 3</td> <td>·8.18</td> <td>Tax amount 3 *3</td> </tr> <tr> <td>TAX-AMT 4</td> <td>·5.50</td> <td>Taxable amount 4 *3</td> </tr> <tr> <td>TAX 4</td> <td>·0.06</td> <td>Tax amount 4 *3</td> </tr> <tr> <td>TAX</td> <td>·73.75</td> <td>Tax total *4</td> </tr> <tr> <td>ROUNDING AMT</td> <td>·4.75</td> <td>Rounding amount (Australia only)</td> </tr> <tr> <td>CANCEL TTL</td> <td>No</td> <td>2 Cancellation count</td> </tr> <tr> <td></td> <td>·108.52</td> <td>Cancellation amount</td> </tr> <tr> <td>RF-MODE TTL</td> <td>No</td> <td>2 Refund mode operation count *4</td> </tr> <tr> <td></td> <td>·3.74</td> <td>Refund mode operation amount *4</td> </tr> <tr> <td>CALCULATOR</td> <td>No</td> <td>10 CAL mode operation count</td> </tr> <tr> <td colspan="3">-----</td> </tr> <tr> <td>CASH</td> <td>No</td> <td>81 Cash sales count</td> </tr> <tr> <td></td> <td>·836.86</td> <td>Cash sales amount</td> </tr> <tr> <td>CHECK</td> <td>No</td> <td>9 Check sales count</td> </tr> <tr> <td></td> <td>·183.60</td> <td>Check sales amount</td> </tr> <tr> <td>CREDIT</td> <td>No</td> <td>10 Credit sales count</td> </tr> <tr> <td></td> <td>·197.17</td> <td>Credit sales amount</td> </tr> <tr> <td>RC</td> <td>No</td> <td>2 Received on Account count</td> </tr> <tr> <td></td> <td>·78.00</td> <td>Received on Account amount</td> </tr> <tr> <td>PD</td> <td>No</td> <td>1 Paid out count</td> </tr> <tr> <td></td> <td>·6.80</td> <td>Paid out amount</td> </tr> <tr> <td>-</td> <td>No</td> <td>8 Subtraction count</td> </tr> <tr> <td></td> <td>·3.00</td> <td>Subtraction amount</td> </tr> <tr> <td>%-</td> <td>No</td> <td>10 Discount/premium count</td> </tr> <tr> <td></td> <td>·4.62</td> <td>Discount/premium amount</td> </tr> <tr> <td>REFUND</td> <td>No</td> <td>7 Refund key count *4</td> </tr> <tr> <td></td> <td>·27.79</td> <td>Refund key amount *4</td> </tr> <tr> <td>ERR CORR</td> <td>No</td> <td>10 Error correction count</td> </tr> <tr> <td></td> <td>·12.76</td> <td>Error correction amount</td> </tr> <tr> <td>#/NS</td> <td>No</td> <td>5 No sale count</td> </tr> <tr> <td colspan="3">-----</td> </tr> <tr> <td>CLERK 01</td> <td>No</td> <td>12 Clerk 1/clerk 1 sales count</td> </tr> <tr> <td></td> <td>·127.63</td> <td>Clerk 1 sales amount</td> </tr> <tr> <td>*****</td> <td></td> <td></td> </tr> <tr> <td>CLERK 02</td> <td>No</td> <td>6 Training clerk</td> </tr> <tr> <td></td> <td>·27.63</td> <td></td> </tr> <tr> <td>*****</td> <td></td> <td></td> </tr> <tr> <td>CLERK 03</td> <td>No</td> <td>24</td> </tr> <tr> <td colspan="3">-----</td> </tr> <tr> <td>GRND TTL</td> <td>·0000351217.63</td> <td>Non-resettable grand-sales total *4</td> </tr> <tr> <td></td> <td>000001---}000253</td> <td>Consecutive No. range of the day *4</td> </tr> </table>	TAX 1	·43.96	Tax amount 1 *3	TAX-AMT 2	·409.72	Taxable amount 2 *3	TAX 2	·21.55	Tax amount 2 *3	TAX-AMT 3	·272.50	Taxable amount 3 *3	TAX 3	·8.18	Tax amount 3 *3	TAX-AMT 4	·5.50	Taxable amount 4 *3	TAX 4	·0.06	Tax amount 4 *3	TAX	·73.75	Tax total *4	ROUNDING AMT	·4.75	Rounding amount (Australia only)	CANCEL TTL	No	2 Cancellation count		·108.52	Cancellation amount	RF-MODE TTL	No	2 Refund mode operation count *4		·3.74	Refund mode operation amount *4	CALCULATOR	No	10 CAL mode operation count	-----			CASH	No	81 Cash sales count		·836.86	Cash sales amount	CHECK	No	9 Check sales count		·183.60	Check sales amount	CREDIT	No	10 Credit sales count		·197.17	Credit sales amount	RC	No	2 Received on Account count		·78.00	Received on Account amount	PD	No	1 Paid out count		·6.80	Paid out amount	-	No	8 Subtraction count		·3.00	Subtraction amount	%-	No	10 Discount/premium count		·4.62	Discount/premium amount	REFUND	No	7 Refund key count *4		·27.79	Refund key amount *4	ERR CORR	No	10 Error correction count		·12.76	Error correction amount	#/NS	No	5 No sale count	-----			CLERK 01	No	12 Clerk 1/clerk 1 sales count		·127.63	Clerk 1 sales amount	*****			CLERK 02	No	6 Training clerk		·27.63		*****			CLERK 03	No	24	-----			GRND TTL	·0000351217.63	Non-resettable grand-sales total *4		000001---}000253	Consecutive No. range of the day *4
Z	15-03-2002	17:20	Reset mode/date/time																																																																																																																																																																																																																																													
CLERK 01	000258		Clerk/consecutive No.																																																																																																																																																																																																																																													
0000	DAILY	Z 0001	Report code/report title/reset symbol/ reset counter *5																																																																																																																																																																																																																																													
DEPT01	QT	1015	Department descriptor/No. of items *2																																																																																																																																																																																																																																													
47.07%		·10339.50	Sales ratio/department amount *2																																																																																																																																																																																																																																													
DEPT02	QT	19																																																																																																																																																																																																																																														
31.87%		·7000.70																																																																																																																																																																																																																																														
DEPT03	QT	31																																																																																																																																																																																																																																														
18.84%		·4139.10																																																																																																																																																																																																																																														
DEPT04	QT	23																																																																																																																																																																																																																																														
1.51%		·332.67																																																																																																																																																																																																																																														
NON-LINK DPT	QT	10	Non-link department No. of items																																																																																																																																																																																																																																													
0.43%		·94.90	Non-link department amount																																																																																																																																																																																																																																													

GROSS TOTAL	QT	1253	Gross No. of items																																																																																																																																																																																																																																													
		·21960.90	Gross sales amount																																																																																																																																																																																																																																													
NET TOTAL	No	545	No. of customers																																																																																																																																																																																																																																													
		·30217.63	Net sales amount																																																																																																																																																																																																																																													
CASH-INDW		·29903.06	Cash in drawer amount (b)																																																																																																																																																																																																																																													
#		·29903.06	Declared amount (a)																																																																																																																																																																																																																																													
		·0.00	Difference (b) - (a)																																																																																																																																																																																																																																													
CHECK-INDW		·197.17	Check in drawer amount																																																																																																																																																																																																																																													
CREDIT-INDW		·183.60	Credit in drawer amount																																																																																																																																																																																																																																													
CE-CASH 1		¥7,000	Foreign currency cash in drawer																																																																																																																																																																																																																																													
CE-CHECK 1		¥4,000	Foreign currency check in drawer																																																																																																																																																																																																																																													
TAX-AMT 1		·732.56	Taxable amount 1 *3																																																																																																																																																																																																																																													
TAX 1	·43.96	Tax amount 1 *3																																																																																																																																																																																																																																														
TAX-AMT 2	·409.72	Taxable amount 2 *3																																																																																																																																																																																																																																														
TAX 2	·21.55	Tax amount 2 *3																																																																																																																																																																																																																																														
TAX-AMT 3	·272.50	Taxable amount 3 *3																																																																																																																																																																																																																																														
TAX 3	·8.18	Tax amount 3 *3																																																																																																																																																																																																																																														
TAX-AMT 4	·5.50	Taxable amount 4 *3																																																																																																																																																																																																																																														
TAX 4	·0.06	Tax amount 4 *3																																																																																																																																																																																																																																														
TAX	·73.75	Tax total *4																																																																																																																																																																																																																																														
ROUNDING AMT	·4.75	Rounding amount (Australia only)																																																																																																																																																																																																																																														
CANCEL TTL	No	2 Cancellation count																																																																																																																																																																																																																																														
	·108.52	Cancellation amount																																																																																																																																																																																																																																														
RF-MODE TTL	No	2 Refund mode operation count *4																																																																																																																																																																																																																																														
	·3.74	Refund mode operation amount *4																																																																																																																																																																																																																																														
CALCULATOR	No	10 CAL mode operation count																																																																																																																																																																																																																																														

CASH	No	81 Cash sales count																																																																																																																																																																																																																																														
	·836.86	Cash sales amount																																																																																																																																																																																																																																														
CHECK	No	9 Check sales count																																																																																																																																																																																																																																														
	·183.60	Check sales amount																																																																																																																																																																																																																																														
CREDIT	No	10 Credit sales count																																																																																																																																																																																																																																														
	·197.17	Credit sales amount																																																																																																																																																																																																																																														
RC	No	2 Received on Account count																																																																																																																																																																																																																																														
	·78.00	Received on Account amount																																																																																																																																																																																																																																														
PD	No	1 Paid out count																																																																																																																																																																																																																																														
	·6.80	Paid out amount																																																																																																																																																																																																																																														
-	No	8 Subtraction count																																																																																																																																																																																																																																														
	·3.00	Subtraction amount																																																																																																																																																																																																																																														
%-	No	10 Discount/premium count																																																																																																																																																																																																																																														
	·4.62	Discount/premium amount																																																																																																																																																																																																																																														
REFUND	No	7 Refund key count *4																																																																																																																																																																																																																																														
	·27.79	Refund key amount *4																																																																																																																																																																																																																																														
ERR CORR	No	10 Error correction count																																																																																																																																																																																																																																														
	·12.76	Error correction amount																																																																																																																																																																																																																																														
#/NS	No	5 No sale count																																																																																																																																																																																																																																														

CLERK 01	No	12 Clerk 1/clerk 1 sales count																																																																																																																																																																																																																																														
	·127.63	Clerk 1 sales amount																																																																																																																																																																																																																																														

CLERK 02	No	6 Training clerk																																																																																																																																																																																																																																														
	·27.63																																																																																																																																																																																																																																															

CLERK 03	No	24																																																																																																																																																																																																																																														

GRND TTL	·0000351217.63	Non-resettable grand-sales total *4																																																																																																																																																																																																																																														
	000001---}000253	Consecutive No. range of the day *4																																																																																																																																																																																																																																														

*1 Money declaration:

Count how much cash is in the drawer and input this amount (up to 8-digits).

The cash register will automatically compare the input with the cash in drawer in the memory and print the difference between these two amounts.

Note that if money declaration is required by programming (page 47), you cannot skip this procedure.

*2 Zero totalled departments (the amount and item numbers are both zero) are not printed.

*3 Taxable amount and tax amount are printed only if the corresponding tax table is programmed.

*4 These items can be skipped by programming.

5 The "" symbol is printed on the reset report, if memory overflow occurred in the totalizer.

To print the periodic-1/-2 sales read/reset reports

These reports show sales breakdowns of sales by any two kinds of period you want.

OPERATION

REPORT

Read: X mode
Reset: Z mode
Mode Switch



1 0 0 (Periodic-1 Read)

3 0 0 (Periodic-2 Read)

2 0 0 (Periodic-1 Reset)

4 0 0 (Periodic-2 Reset)



CA/AMT
= /TEND

Z	15-03-2002	17:40		Reset mode/date/time
CLERK	01	000257		Clerk/consecutive No.
0200	PERIODIC-1	ZZ0001		Report code/report title/reset symbol/ reset counter
DEPT01	QT	1015		Department descriptor/No. of items *1
		47.07%	·10339.50	Sales ratio/department amount *1
DEPT02	QT	19		
		31.87%	·7000.70	
DEPT03	QT	31		
		18.84%	·4139.10	
DEPT04	QT	23		
		1.51%	·332.87	
NON-LINK DPT	QT	10		Non-link department No. of items
		0.43%	·94.90	Non-link department amount

GROSS TOTAL	QT	1253		Gross No. of items
			·21960.90	Gross sales amount
NET TOTAL	No	545		No. of customers
			·30217.63	Net sales amount
CASH-INDW			·29903.06	Cash in drawer amount
CHECK-INDW			·197.17	Check in drawer amount
CREDIT-INDW			·183.60	Credit in drawer amount
TAX-AMT 1			·732.56	Taxable amount 1 *2
TAX 1			·43.96	Tax amount 1 *2
TAX-AMT 2			·409.72	Taxable amount 2 *2
TAX 2			·21.55	Tax amount 2 *2
TAX-AMT 3			·272.50	Taxable amount 3 *2
TAX 3			·8.18	Tax amount 3 *2
TAX-AMT 4			·5.50	Taxable amount 4 *2
TAX 4			·0.06	Tax amount 4 *2
TAX			·73.75	Tax total *3
ROUNDING AMT			·4.75	Rounding amount (Australia only)
CANCEL TTL	No	2		Cancellation count
			·108.52	Cancellation amount

RF-MODE	TTL	No	2	Refund mode operation count *3
			·3.74	Refund mode operation amount *3
CALCULATOR		No	10	CAL mode operation count

CASH		No	81	Cash sales count
			·836.86	Cash sales amount
CHECK		No	9	Check sales count
			·183.60	Check sales amount
CREDIT		No	10	Credit sales count
			·197.17	Credit sales amount
RC		No	2	Received on Account count
			·78.00	Received on Account amount
PD		No	1	Paid out count
			·6.80	Paid out amount
-		No	8	Subtraction count
			·3.00	Subtraction amount
%-		No	10	Discount/premium count
			·4.62	Discount/premium amount
REFUND		No	7	Refund key count *3
			·27.79	Refund key amount *3
ERR CORR		No	10	Error correction count
			·12.76	Error correction amount
#/NS		No	5	No sale count

CLERK 01		No	12	Clerk 1/clerk 1 sales count
			·127.63	Clerk 1 sales amount

CLERK 02		No	6	Training clerk
			·27.63	

CLERK 03		No	24	
			·217.63	

*1 Zero totalled departments (the amount and item numbers are both zero) are not printed.

*2 Taxable amount and tax amount are printed only if the corresponding tax table is programmed.

*3 These items can be skipped by programming.

Convenient Operations and Setups

To print the open check read/reset report

This report shows previous balance of non-closed checks.

OPERATION	REPORT
<div style="border: 1px solid black; border-radius: 15px; padding: 10px; width: fit-content; margin: 0 auto;"> <p>Read: X mode Reset: Z mode</p> <p>Mode Switch</p> </div> <p style="text-align: center;">↓</p> <div style="display: flex; justify-content: center; gap: 20px;"> <div style="text-align: center;"> <p>2 5 CA/AMT =/TEND</p> <p>↓</p> <p>Individual All</p> <p>↓ ↓</p> <p>Check No. CA/AMT =/TEND</p> <p>↓</p> <p>* NEW</p> </div> </div>	<pre style="font-family: monospace; font-size: 0.9em;"> Z 15-03-2002 17:45 CLERK 01 000258 0025 OPEN CHECK Z CHECK-#: 123456 REG 15-01-2002 12:30 CLERK 01 000108 .12.24 CHECK-#: 123556 REG 15-01-2002 13:40 CLERK 01 000132 .82.04 CHECK-#: 215485 REG 15-01-2002 17:10 CLERK 01 000203 .22.38 ----- TOTAL .338.40 </pre> <p style="font-size: 0.8em; margin-top: 5px;"> Reset mode/date/time Clerk/consecutive No. Report code/report title/reset symbol Check No. Mode/date/time Clerk/consecutive No. Previous balance Total amount (prints on the "All" report only) </p>

* You can use the OLD key or the New/Old
Check key instead.

Reading the cash register's program

To print unit price/rate program (except PLU)

OPERATION	REPORT
<div style="border: 1px solid black; border-radius: 15px; padding: 10px; width: fit-content; margin: 0 auto;"> <p>PGM mode</p> <p>Mode Switch</p> </div> <p style="text-align: center;">↓</p> <div style="text-align: center;"> <p>1 SUB TOTAL</p> <p>↓</p> <p>SUB TOTAL</p> </div>	<pre style="font-family: monospace; font-size: 0.9em;"> PGM1 10-03-2002 09:30 CLERK 01 000010 PGM1 DEPT01 T1 @1.00 DEPT02 @2.00 DEPT03 @0.00 DEPT04 @0.00 - @0.00 %- 12.34% CURR EXG 105.05 </pre> <p style="font-size: 0.8em; margin-top: 5px;"> Mode/date/time Clerk/consecutive No. Program read symbol Dept. descriptor/tax status/unit price *1 Reduction preset amount Percent rate Currency exchange rate </p>

*1 Departments without being programmed are not printed on this report.

To print the PLU program

OPERATION	REPORT																																																						
<div style="border: 1px solid black; border-radius: 15px; padding: 10px; width: fit-content; margin: 0 auto;"> <p style="font-size: 24px; margin: 0;">PGM mode</p> <p style="margin: 5px 0;">Mode Switch</p> <p style="text-align: center;">↓</p> <div style="display: flex; align-items: center; justify-content: center; gap: 5px;"> <div style="border: 1px solid black; padding: 2px 5px; font-weight: bold; font-size: 18px;">6</div> <div style="border: 1px solid black; padding: 2px 5px; font-size: 10px;">SUB TOTAL</div> </div> <p style="text-align: center;">↓</p> <div style="border: 1px solid black; padding: 2px 5px; font-size: 10px;">SUB TOTAL</div> </div>	<table border="1" style="width: 100%; border-collapse: collapse;"> <tr> <td style="width: 70%;">PGM6 10-03-2002 09:45</td> <td style="width: 30%;">Mode/date/time</td> </tr> <tr> <td>CLERK 01 000013</td> <td>Clerk/consecutive No.</td> </tr> <tr> <td>PGM6</td> <td>Program read symbol</td> </tr> <tr> <td>PLU0001 T1 0001</td> <td>Item character/tax symbol/PLU No.</td> </tr> <tr> <td>0000100000 @1.00</td> <td>Status program/unit price *1</td> </tr> <tr> <td>PLU0002 0002</td> <td></td> </tr> <tr> <td>0000000000 @2.00</td> <td></td> </tr> <tr> <td>PLU0003 0003</td> <td></td> </tr> <tr> <td>0000000000 @3.00</td> <td></td> </tr> <tr> <td>PLU0004 0004</td> <td></td> </tr> <tr> <td>0000000000 @4.00</td> <td></td> </tr> <tr> <td>PLU0005 0005</td> <td></td> </tr> <tr> <td>0000000000 @5.00</td> <td></td> </tr> <tr> <td>PLU0006 0006</td> <td></td> </tr> <tr> <td>0000000000 @6.00</td> <td></td> </tr> <tr> <td>PLU0007 T2 0007</td> <td></td> </tr> <tr> <td>0000200000 @7.00</td> <td></td> </tr> <tr> <td>PLU0008 0008</td> <td></td> </tr> <tr> <td>0000000000 @8.00</td> <td></td> </tr> <tr> <td>PLU0009 0009</td> <td></td> </tr> <tr> <td>0000000000 @9.00</td> <td></td> </tr> <tr> <td>PLU0010 0010</td> <td></td> </tr> <tr> <td>..... @10.00</td> <td></td> </tr> <tr> <td>PLU0499 T2 0000</td> <td></td> </tr> <tr> <td>0000200000 @499.00</td> <td></td> </tr> <tr> <td>PLU0500 0500</td> <td></td> </tr> <tr> <td>0000000000 @500.00</td> <td></td> </tr> </table>	PGM6 10-03-2002 09:45	Mode/date/time	CLERK 01 000013	Clerk/consecutive No.	PGM6	Program read symbol	PLU0001 T1 0001	Item character/tax symbol/PLU No.	0000100000 @1.00	Status program/unit price *1	PLU0002 0002		0000000000 @2.00		PLU0003 0003		0000000000 @3.00		PLU0004 0004		0000000000 @4.00		PLU0005 0005		0000000000 @5.00		PLU0006 0006		0000000000 @6.00		PLU0007 T2 0007		0000200000 @7.00		PLU0008 0008		0000000000 @8.00		PLU0009 0009		0000000000 @9.00		PLU0010 0010	 @10.00		PLU0499 T2 0000		0000200000 @499.00		PLU0500 0500		0000000000 @500.00	
PGM6 10-03-2002 09:45	Mode/date/time																																																						
CLERK 01 000013	Clerk/consecutive No.																																																						
PGM6	Program read symbol																																																						
PLU0001 T1 0001	Item character/tax symbol/PLU No.																																																						
0000100000 @1.00	Status program/unit price *1																																																						
PLU0002 0002																																																							
0000000000 @2.00																																																							
PLU0003 0003																																																							
0000000000 @3.00																																																							
PLU0004 0004																																																							
0000000000 @4.00																																																							
PLU0005 0005																																																							
0000000000 @5.00																																																							
PLU0006 0006																																																							
0000000000 @6.00																																																							
PLU0007 T2 0007																																																							
0000200000 @7.00																																																							
PLU0008 0008																																																							
0000000000 @8.00																																																							
PLU0009 0009																																																							
0000000000 @9.00																																																							
PLU0010 0010																																																							
..... @10.00																																																							
PLU0499 T2 0000																																																							
0000200000 @499.00																																																							
PLU0500 0500																																																							
0000000000 @500.00																																																							

*1 PLUs without being programmed are not printed on this report.

To print the keyboard layout program

OPERATION	REPORT																				
<div style="border: 1px solid black; border-radius: 15px; padding: 10px; width: fit-content; margin: 0 auto;"> <p style="font-size: 24px; margin: 0;">PGM mode</p> <p style="margin: 5px 0;">Mode Switch</p> <p style="text-align: center;">↓</p> <div style="display: flex; align-items: center; justify-content: center; gap: 5px;"> <div style="border: 1px solid black; padding: 2px 5px; font-weight: bold; font-size: 18px;">4</div> <div style="border: 1px solid black; padding: 2px 5px; font-size: 10px;">SUB TOTAL</div> </div> <p style="text-align: center;">↓</p> <div style="border: 1px solid black; padding: 2px 5px; font-size: 10px;">SUB TOTAL</div> </div>	<table border="1" style="width: 100%; border-collapse: collapse;"> <tr> <td style="width: 70%;">PGM4 10-03-2002 09:45</td> <td style="width: 30%;">Mode/date/time</td> </tr> <tr> <td>CLERK 01 000013</td> <td>Clerk/consecutive No.</td> </tr> <tr> <td>PGM4</td> <td>Program read symbol</td> </tr> <tr> <td>00 96-011</td> <td>Key descriptor/memory No./</td> </tr> <tr> <td>. 99-012</td> <td>function code/hard key code</td> </tr> <tr> <td>REFUND 33-013</td> <td></td> </tr> <tr> <td>DEPT01 01-51-041</td> <td></td> </tr> <tr> <td>DEPT02 02-51-042</td> <td></td> </tr> <tr> <td>PLU0004 62-067</td> <td></td> </tr> <tr> <td>PLU0005 63-067</td> <td></td> </tr> </table>	PGM4 10-03-2002 09:45	Mode/date/time	CLERK 01 000013	Clerk/consecutive No.	PGM4	Program read symbol	00 96-011	Key descriptor/memory No./	. 99-012	function code/hard key code	REFUND 33-013		DEPT01 01-51-041		DEPT02 02-51-042		PLU0004 62-067		PLU0005 63-067	
PGM4 10-03-2002 09:45	Mode/date/time																				
CLERK 01 000013	Clerk/consecutive No.																				
PGM4	Program read symbol																				
00 96-011	Key descriptor/memory No./																				
. 99-012	function code/hard key code																				
REFUND 33-013																					
DEPT01 01-51-041																					
DEPT02 02-51-042																					
PLU0004 62-067																					
PLU0005 63-067																					

Convenient Operations and Setups

To print key descriptor, name, message program (except PLU)

OPERATION

REPORT

PGM mode

Mode Switch

2 SUB TOTAL

SUB TOTAL

PGM2 10-03-2002 09:35	Mode/date/time
CLERK 01 000011	Clerk/consecutive No.
PGM2.....	Program read symbol
GROSS TOTAL 01	Gross character
NET TOTAL 02	Net character
CASH-INDW 03	Cash in drawer character
CHARGE-INDW 04	Charge in drawer character
CREDIT-INDW 05	
CE-CASH 1 07	Foreign currency cash character
CE-CHECK 1 08	Foreign currency check character
CE-CHECK 2 09	
TAX-AMT 1 11	Taxable amount 1 character
TAX 1 12	Tax 1 character
TAX-AMT 2 13	
TAX 2 14	
ROUNDING AMT 22	Rounding character
CANCEL TTL 23	Cancellation total character
RF-MODE TTL 24	Refund mode total character
COMMISSION 25	
CALCULATOR 27	
NON-LINK DPT 28	Non link department character
CASH 01	Cash key descriptor
TL 02	
CREDIT 03	
CHECK 04	Check key descriptor
PD 05	Paid out key descriptor
R ON/OFF 06	Receipt on/off key descriptor
#/NS 07	
RC 08	
OPN/CLK# 15	
REFUND 16	
- 24	

%-	25	
P/G RCT	26	
CURR EXG	40	Currency exchange key descriptor
ARG	47	
DEPT01	01	Department 1 key character
DEPT02	02	Department 2 key character
DEPT03	03	
DEPT04	04	Department 4 key character
CLERK 01	01	Clerk 01 character
CLERK 02	02	Clerk 02 character
CLERK 19	19	
CLERK 20	20	Clerk 20 character
GRND TTL	01	Grand total character
@NoQT	01	
NoCT	02	
X /	03	
T1T2T3T4	04	Special character
	05	
	30	
	31	
DAILY	01	
PLU	02	
HOURLY	03	
PERIODIC-1	04	Report header
PERIODIC-2	05	
OPEN CHECK	12	
E-JOURNAL	01	
	02	
* INDICATOR RECEIPT	19	Receipt message
TAXABLE SUPPLY		
TEXT RECALL 01	01	
TEXT RECALL 02	02	Text recall message
	10	

To print the print control, compulsory clerk program (except PLU)

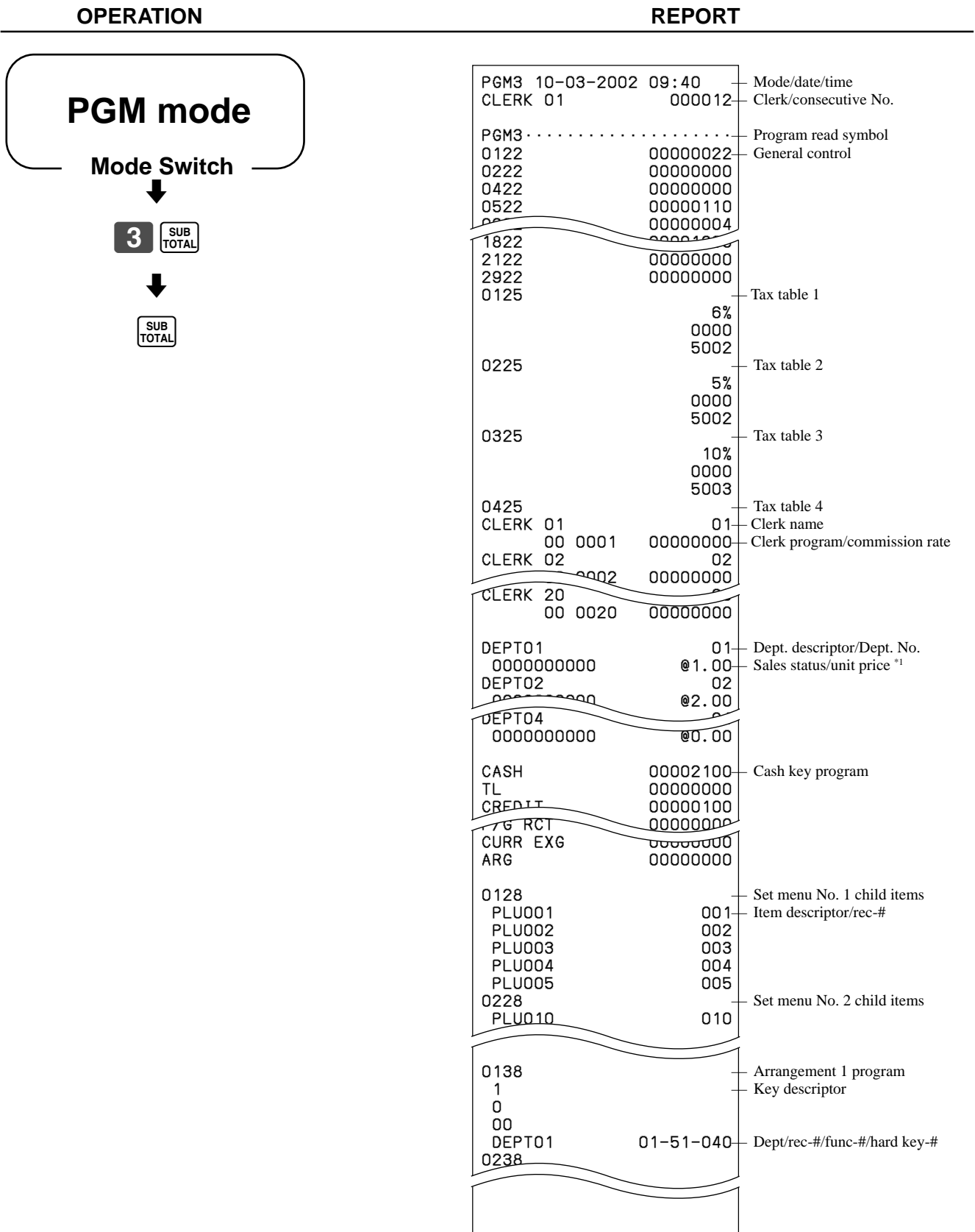

*1 Departments without being programmed are not printed on this report.

Troubleshooting

This section describes what to do when you have problems with operation.

When an error occurs

Errors are indicated by an error tone. When this happens, you can usually find out what the problem is as shown below.

Error code (Message)	Meaning	Action
E01 (ERR-MODE)	Mode switch position changed before finalization.	Return the mode switch to its original setting and finalize the operation.
E03 (ERR-CLK)	The signed on clerk differs from the clerk performed the check tracking operation.	Input correct check number or assign the proper clerk number.
E08 (SIGN-ON)	Registration without entering a clerk number.	Enter a clerk number.
E10 (PRNT-LID)	Platen arm of the printer is opened.	Close the platen arm.
E11 (DRW-OPEN)	Registration is made while the cash drawer is opened.	Close the cash drawer.
E12 (JPAP-END)	Journal paper end	Replace the new paper roll.
E14 (RPAP-END)	Receipt paper end	Replace the new paper roll.
E17 (CHECK-NO)	Attempt made to register an item without inputting a table number.	Input a table number.
E19 (COVERS)	Registration without inputting number of customers.	Input number of customers.
E27 (BUF-FULL)	Transaction cancel buffer full.	Finalize the transaction.
E31 (PRESS-ST)	Finalization of a transaction attempted without confirming the subtotal.	Press the  key.
E33 (TEND-AMT)	Finalize operation attempted without entering amount tender.	Enter the amount tendered.
E35 (CNG-OVER)	Change amount exceeds preset limit.	Input amount tendered again.
E38 (DECL-AMT)	Read/reset operation without declaring cash in drawer. This error appears only when this function is activated.	Perform money declaration.
E40 (PRNT-RCT)	Attempt made to finalize a transaction without issuing a guest receipt.	Issue a guest receipt.
E50 (MEM-FULL)	Check tracking memory full	Finalize and close the check number currently used.
E51 (OCCUPIED)	Attempt made to use the new check key to open a new check using a number that is already used for an existing check in check tracking memory.	Finalize and close the check that is currently under used or use a different check number.
E53 (NOT-OPEN)	Attempt made to use the old check key to reopen a new check using a number that is not used for an existing check in check tracking memory.	Use the correct check number (if you want to reopen a check that already exists in the check tracking memory) or use the new check key to open a new check.

When the register does not operate at all

Perform the following check whenever the cash register enters an error condition as soon as you switch it on. The results of this check are required by service personnel, so be sure to perform this check before you contact a CASIO representative for servicing.

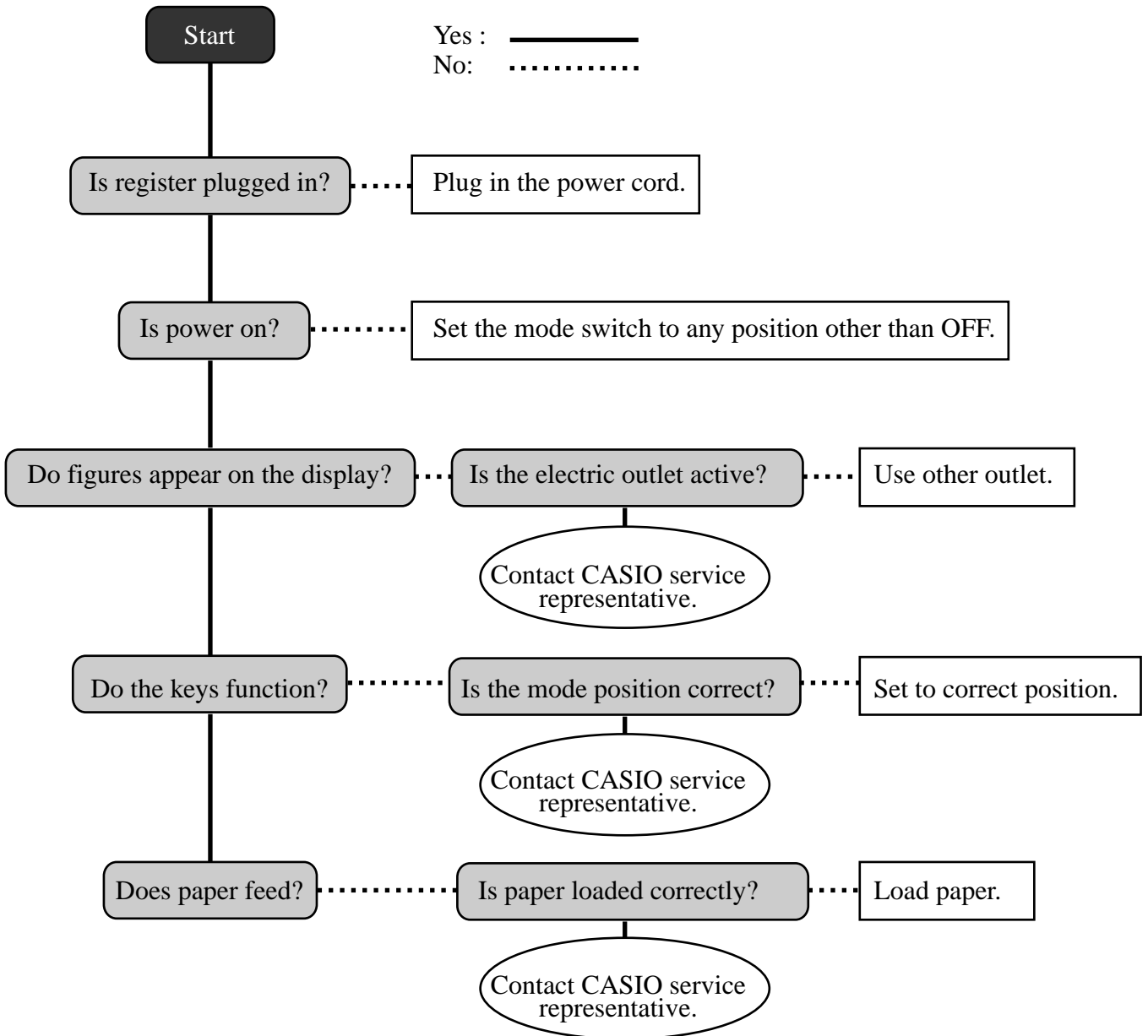

In case of power failure

If the power supply to the cash register is cut by a power failure or any other reason, simply wait for power to be restored. The details of any ongoing transaction as well as all sales data in memory are protected by the memory backup batteries.

- Power failure during a registration
The subtotal for items registered up to the power failure is retained in memory. You will be able to continue with the registration when power is restored.
- Power failure during printing a read/reset report
The data already printed before the power failure is retained in memory. You will be able to issue a report when power is restored.
- Power failure during printing of a receipt and the journal
Printing will resume after power is restored. A line that was being printed when the power failure occurred is printed in full.
- Other
The power failure symbol is printed and any item that was being printed when the power failure occurred is reprinted in full.

Important!

Once receipt/journal printing or printing of a report starts, it can be stopped only by interruption of power to the cash register.

When the L sign appears on the display

About the low battery indicator...

The following shows the low battery indicator.



If this indicator appears when you switch the cash register on, it can mean one of three things:

- No memory backup batteries are loaded in the cash register.
- The power of the batteries loaded in the unit is below a certain level.
- The batteries loaded in the unit are dead.

To clear this sign, press  key.

Important!

Whenever the low battery indicator appears on the display, load a set of three new batteries as soon as possible. If there is a power failure or you unplug the cash register when this indicator appears, you will lose all of your sales data and settings.

**BE SURE TO KEEP THE POWER CORD OF THE CASH REGISTER
PLUGGED IN WHENEVER YOU REPLACE THE BATTERIES.**

To replace journal paper



Step 1

Set the mode switch to the REG position and remove the printer cover.

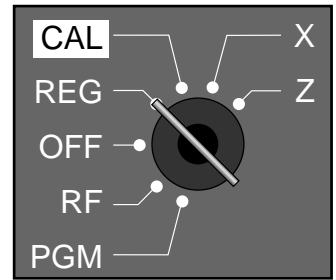

Step 2

Press **FEED** to feed about 20 cm of paper.



Step 6

Slide the printed journal from the take-up reel.



Step 3

Cut the journal paper at the point where nothing is printed.



Step 7

Open the platen arm.



Step 4

Remove the journal take-up reel from its holder.



Step 8

Remove the old paper roll from the cash register.



Step 5

Remove the paper guide from the take-up reel.

Step 9

Load new paper.

Go to the step 3 described on page 10 of this manual.

To replace receipt paper



Step 1

Set the mode switch to the REG position and remove the printer cover.

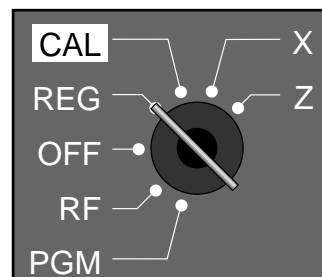

Step 2

Open the platen arm.



Step 3

Remove the old paper roll from the cash register.

Step 4

Load new paper.

Go to the step 3 described on page 9 of this manual.

NOTE:

After completion of register programming, enter **6 2 0 0** and **SUB TOTAL** in the PGM 3 mode (PGM mode ⇒ **3** **SUB TOTAL**) to backup the program data into the internal non-volatile memory.

(This operation takes about 10 seconds.)

Options

WT-83 wetproof cover

The optional wetproof cover protects the keyboard from moisture damage.

Consult your CASIO dealer for details.

Specifications

Input method

Entry: 10-key system; Buffer memory 8 keys (2-key roll over)
 Department: Full key system

Display

Amount 8 digits (Zero suppression) ; No. of repeats, Receipt On/Off
 Character 8 digits; Item descriptor, Key descriptor, Mode

Printer

Printer: Single sheet dot matrix thermal printer (Receipt or journal printing)
 24 digits (Amount 10 digits/descriptor 8, 12 or 24 digits)
 Journal: Automatic take up roll winding
 Print speed: Max. 14 lines/sec.
 Feed speed: Max. 14 lines/sec.
 Paper roll: 58 mm × 80 mm Ø (Max.)
 CASIO P-5880T

Calculations

Entry 8 digits; Registration 7 digits; Total 8 digits

Chronological data

Date print: Automatic date printout on receipt or journal
 Automatic calendar
 Time print: Automatic time printout on receipt or journal
 Time display: 24-hour system

Alarm

Entry confirmation signal; Error alarm

Totalizers

Category	No. of Totalizers	Contents				Periodic Totalizer
		Amount (10 digits)	No. of items (4 digits)	Count (4 digits)	No. of customers (4 digits)	
Department	4 (8)	✓	✓*1			✓
PLU	1200	✓	✓*1			
Hourly sales	24	✓			✓	
Monthly	31	✓			✓	
Clerk	20	✓			✓	
Transaction	51	✓ or	✓ or	✓ or	✓	✓
Non resettable grand sales total	1	✓*2				
Reset counter	6			✓		✓
Consecutive No.	1			✓		

*1: 4 digit integer + 2 digit decimal, *2: 12 digits

Memory protection batteries

The effective service life of the memory protection batteries (three new SUM-3 or UM-3 type batteries) is approximately one year from installation into the machine.

Power supply/ Power consumption

As noted on the plate affixed to right side of register.

Operating temperature

0°C ~ 40°C

Humidity

10 ~ 90%

Dimensions and Weight

275 mm (H) × 365 mm (W) × 474 mm (D) / 7.8kg with small size drawer
 291 mm (H) × 410 mm (W) × 474 mm (D) / 11kg with medium size drawer

The CE marking below applies to the EU region. Declarer of conformity is as follows:



Casio Electronics Co., Ltd.
 Unit 6, 1000 North Circular Road
 London NW2 7JD, U.K.

* Specifications and design are subject to change without notice.

- A**
- add check 83
 - add check key 20
 - add/price key 20
 - alphabet keys 57
 - arrangement 77, 83
 - Australian rounding 15
 - auto sign-off 46
 - auto-cash function 75
- B**
- backspace/character code fixed key 57
 - bottom message 22
- C**
- CAL mode 18
 - calculator mode 18, 80
 - cancel 43
 - CAPS key 57
 - cash amount tendered key 21, 78
 - change preparation 25
 - character code list 58
 - character enter key 57
 - character entering 57
 - character fixed key 57
 - character keyboard 57
 - charge 37, 78
 - check 37, 78
 - check (adding to) 72
 - check (closing) 73
 - check (opening) 72
 - check key 21
 - check tracking system 72
 - child PLU 75
 - clear 41
 - clear key 20
 - clerk commission 50
 - clerk interrupt function 50
 - clerk name 51, 52
 - clerk number 49, 83
 - clerk number key 20
 - clerk sign on and sign off 24
 - commercial message 22
 - commission rate 50, 58, 61, 62, 63, 64
 - compulsory check number 72
 - compulsory guest receipt 72
 - condiment 76
 - consecutive No. range 49
 - consecutive number 22
 - correction 41
 - credit 78
 - credit balance 78
 - credit key 21
 - currency exchange 69, 83
 - customer display 17, 19
- D**
- daily sales report 44, 88
 - Danish rounding 15, 78
 - date setting 12
 - daylight saving time 81
 - decimal symbol 46
 - department 19, 26, 27, 51, 59, 83, 84, 88, 92
 - department key 20
 - digit separator symbol 46
 - discount 83
 - discount (percent) 33, 67
 - discount key 20
 - display 17, 19
 - displaying the time 25
 - displaying the time and date 25
 - drawer 17, 18
 - drawer key 17
 - drawer lock 17
 - drawer release lever 18
- E**
- electronic journal memory 49, 87
 - error code 94
 - error correct 42
 - error correct/cancel 83
 - error correct/cancel key 21
- F**
- financial report 85
 - flat-PLU 31, 55, 63, 83
 - flat-PLU key 20
 - force entry of the amount tendered 78
- G**
- grand-sales total 88
 - group link 61, 62, 64
 - guest receipt key 20
 - guest/post receipt key 20
- H**
- hash department 58, 61, 62, 63, 64
 - high amount limit 78
 - high digit limit 58, 61, 62, 63, 64, 78
- I**
- item counter 22
- J**
- journal 22
 - journal compressed print 46
 - journal skip 22, 46
- K**
- key descriptor 51, 56
 - keyboard 17
 - keyboard layout 82, 91
- L**
- L sign 96
 - logo message 22
 - low battery indicator 96

M

machine number 49
main display 17, 19
manual tax 83
memory recall 80
menu shift 83
menu shift key 20
message 22
minus 79, 83
minus (reduction) 35
minus key 21
mode key 17
mode switch 17, 18
money declaration 46, 85, 88
multiplication 26, 30
multiplication/date/time 83
multiplication/date/time key 20
multipurpose tray 17, 18

N

negative department 58, 61, 62, 63, 64
new balance key 21
new check 83
new check key 21
new/old check 83
no sale 43, 83
no sale key 21
non-add 37, 83
non-add key 21
non-add/no sale key 21
non-resettable grand total 88
number of customers 83

O

old check 83
old check key 21
open 65, 83
open check report 90
open key 20
open/clerk number key 20
operator display 17, 19
operator key 17

P

paid out 40, 83
paid out key 20
payout 79
paper feed key 20
paper installation 9
paper loading 9
paper replacement 97, 98
parent PLU 75
percent 33, 67
periodic report 89
PGM mode 18
PLU 29, 30, 54, 55, 61, 63, 83, 84, 86, 91
PLU key 20
plus 79, 83
pop-up display 17, 19

post receipt 45
post receipt key 20
post receipt/guest receipt 83
power failure 96
premium 68, 83
preparation 76
preset open 83
preset price 27, 28, 29
price 66, 83
price key 20
print subtotal 46
print tax rate with tax totalizer 49
print the sales ratio 49
print VAT breakdown 78
printer 17
printer cover 17
printout selection 12
program end key 57
program key 17
program mode 18
program read 90, 91, 92, 93
prohibit cancel operation 46

R

read mode 18
read report 84, 85, 86, 87, 88, 89, 90
recall character 83
receipt message 53
receipt on/off indicator 19
receipt on/off key 20
received on account 40, 79, 83
received on account key 20
reduction (minus) 35
refund 83
refund (return) 38, 39
refund key 21
refund mode 18
REG mode 18
register mode 18
repeat 19, 26, 30, 66
report descriptor 51
report title 51, 52
reset mode 18
reset report 44, 84, 86, 87, 88, 89, 90
reset the consecutive number 46
return 38, 39
RF mode 18
roll paper installation 9
roll paper specification 99
rounding 15
rounding (Australian rounding) 15
rounding (Danish rounding) 15
rounding (special rounding) 15

Index

S

set menu 75
shift key 57
sign off 24
sign on 24
single item sale 26, 30, 58, 61, 62, 64, 65, 66
skip zero total lines 49
space key 57
special rounding 15
stand-by mode 18
store number (machine number) 48
subdepartment 61, 62, 66
subtotal 26, 83
subtotal key 21

T

take-up reel 17
tax calculation 28
tax shift 83
tax status 27, 29, 33, 35
tax table programming 13, 15
taxable status 78
time setting 12
time system (12/24Hr) 46
tip 83
training clerk 49, 88, 89

V

VAT 83
void 83

W

wetproof cover 17

X

X mode 18
X report (read report) 84, 85, 86, 87, 88, 89, 90

Z

Z mode 18
Z report (reset report) 44, 84, 86, 87, 88, 89, 90

CASIO®

MO0204-D Printed in Indonesia

TK-T200*E

CASIO COMPUTER CO., LTD.
6-2, Hon-machi 1-chome
Shibuya-ku, Tokyo 151-8543, Japan

Printed on recycled paper.