

Touch Screen Smart Terminal QT-6000

User's Manual

Introduction

Table of Contents

Introducing QT-6000

Display/Keyboard

Basic Operations & Setups

Registrations

Programs

Advanced Operations

Useful Features

Reports

Troubleshooting

Error Code Table

Index

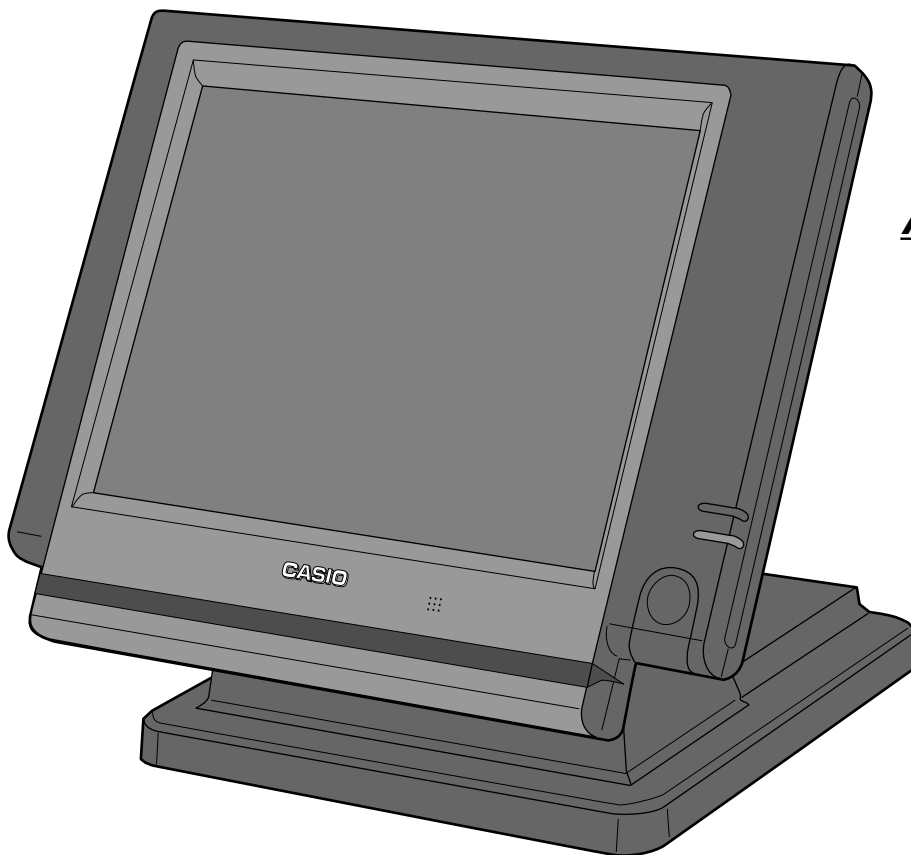

Eu

Di

U.K.

CI

Canada

CASIO®

Introduction

Congratulations on your selection of a CASIO QT-6000 touch screen smart terminal. This terminal is the product of the world's most advanced electronic technology, for outstanding versatility and reliability. Simplified operation is made possible by a specially designed touch screen and a wide selection of automated, programmable functions.

A specially designed keyboard layout and a bright, easy-to-read color display help to take the fatigue out of long hours operation.



Casio Europe GmbH
Bornbarch 10, 22848 Norderstedt
Germany

WARNING: This is a Class A product. In a domestic environment this product may cause radio interference in which case the user may be required to take adequate measures.

Please keep all information for future reference.

GUIDELINES LAID DOWN BY FCC RULES FOR USE OF THE UNIT IN THE U.S.A. (Not applicable to other areas)

WARNING: This equipment has been tested and found to comply with the limits for a Class A digital device, pursuant to Part 15 of the FCC Rules. These limits are designed to provide reasonable protection against harmful interference when the equipment is operated in a commercial environment. This equipment generates, uses, and can radiate radio frequency energy and, if not installed and used in accordance with the instruction manual, may cause harmful interference to radio communications. Operation of this equipment in a residential area is likely to cause harmful interference in which case the user will be required to correct the interference at his own expense.

FCC WARNING: Changes or modifications not expressly approved by the party responsible for compliance could void the user's authority to operate the equipment.

Apparaten skall anslutas till jordat nätuttag.



Batterij niet
weggooien, maar
inleveren als KCA.



This product Contains Mercury and must be recycled or Deposited of Properly.
Este producto contiene mercurio y debe ser reciclado o eliminado apropiadamente.

The main plug on this equipment must be used to disconnect mains power.
Please ensure that the socket outlet is installed near the equipment and shall be easily accessible.

In the operation examples contained in this manual, the print and display samples are not actual size. Also, all samples are just images.

Safety Precautions

- To use this product safely and correctly, read this manual thoroughly and operate as instructed.
After reading this guide, keep it close at hand for easy reference.
Please keep all informations for future reference.
- Always observe the warnings and cautions indicated on the product.

About the icons

In this guide various icons are used to highlight safe operation of this product and to prevent injury to the operator and other personnel and also to prevent damage to property and this product. The icons and definitions are given below.



Indicates that there is a risk of severe injury or death if used incorrectly.



Indicates that injury or damage may result if used incorrectly.

Icon examples

To bring attention to risks and possible damage, the following types of icons are used.



The Δ symbol indicates that it includes some symbol for attracting attention (including warning). In this triangle the actual type of precautions to be taken (electric shock, in this case) is indicated.



The \otimes symbol indicates a prohibited action. In this symbol the actual type of prohibited actions (disassembly, in this case) will be indicated.



The \bullet symbol indicates a restriction. In this symbol the type of actual restriction (removal of the power plug from an outlet, in this case) is indicated.

Warning!

Handling the terminal



Should the terminal malfunction, start to emit smoke or a strange odor, or otherwise behave abnormally, immediately shut down the power and unplug the AC plug from the power outlet. Continued use creates the danger of fire and electric shock.

- Contact CASIO service representative.



Do not place containers of liquids near the terminal and do not allow any foreign matter to get into it. Should water or other foreign matter get into the terminal, immediately shut down the power and unplug the AC plug from the power outlet. Continued use creates the danger of shorting, fire and electric shock.

- Contact CASIO service representative.



Should you drop the terminal and damage it, immediately shut down the power and unplug the AC plug from the power outlet. Continued use creates the danger of shorting, fire and electric shock.

- Attempting to repair the terminal yourself is extremely dangerous. Contact CASIO service representative.
-

Warning!



Never try to take the terminal apart or modify it in any way. High-voltage components inside the terminal create the danger of fire and electric shock.

- Contact CASIO service representative for all repair and maintenance.

AC adaptor, Power plug and AC outlet



Use only a proper AC electric outlet (100V~240V) . Use of an outlet with a different voltage from the rating creates the danger of malfunction, fire, and electric shock. Overloading an electric outlet creates the danger of overheating and fire.

Please use the adaptor (ADP820A) specified for this terminal. Use another adaptor may cause fire, electrical shock, or malfunction.



Make sure the power plug is inserted as far as it will go. Loose plugs create the danger of electric shock, overheating, and fire.

- Do not use the terminal if the plug is damaged. Never connect to a power outlet that is loose.



Use a dry cloth to periodically wipe off any dust built up on the prongs of the plug. Humidity can cause poor insulation and create the danger of electric shock and fire if dust stays on the prongs.



Do not allow the power cord or plug to become damaged, and never try to modify them in any way. Continued use of a damaged power cord can cause deterioration of the insulation, exposure of internal wiring, and shorting, which creates the danger of electric shock and fire.

- Contact CASIO service representative whenever the power cord or plug requires repair or maintenance.

Caution!



Do not place the terminal on an unstable or uneven surface. Doing so can cause the terminal — especially when the drawer is open — to fall, creating the danger of malfunction, fire, and electric shock.



Do not place the terminal in the following areas.

- Areas where the terminal will be subject to large amounts of humidity or dust, or directly exposed to hot or cold air.
- Areas exposed to direct sunlight, in a close motor vehicle, or any other area subject to very high temperatures.

The above conditions can cause malfunction, which creates the danger of fire.



Do not overlay bend the power cord, do not allow it to be caught between desks or other furniture, and never place heavy objects on top of the power cord. Doing so can cause shorting or breaking of the power cord, creating the danger of fire and electric shock.



Be sure to grasp the plug when unplugging the power cord from the wall outlet. Pulling on the cord can damage it, break the wiring, or cause short, creating the danger of fire and electric shock.



Never touch the plug while your hands are wet. Doing so creates the danger of electric shock. Pulling on the cord can damage it, break the wiring, or cause short, creating the danger of fire and electric shock.

Never touch the printer head and the platen.

Introduction & Contents	6
Introducing QT-6000	10
General guide	10
Touch screen panel	13
Main display part	14
Keyboard part	16
Keyboard part with pop-up window	18
List pop-up window	18
Check number pop-up window	18
Allocatable functions	19
Keys in check No. pop-up window	21
Basic Operations and Setups	22
How to use the terminal	22
Clerk sign on/off and mode change	23
Assigning a clerk	23
Clerk key	23
Clerk number key	23
i-Button key	23
Mode change	24
Mode pop-up window	24
Displaying the time and date	25
To display and clear the date/time	25
Adjusting the time and date	25
To adjust the time	25
To adjust the date	25
Preparing and using flat-PLU keys	26
Registering flat-PLU keys	26
Programming to flat-PLU	27
Flat-PLU unit price programming procedure	27
Flat-PLU department link/tax status/listing capacity programming procedure	28
Registering flat-PLU keys by programming data	29
Preset price	29
Preset tax status	29
Locking out high amount limitation	29
Preparing and using discounts/reductions	30
Programming discount rate and reduction amount	30
Registering discounts	31
Discount for items and subtotals	31
Registering reductions	32
Reduction for items	32
Reduction for subtotal	32
Registering credit and check payments	33
Check	33
Credit	33
Mixed tender (cash, credit and check)	33
Registering both the Euro and local currency	34
Registering returned goods in the REG mode	36
Registering returned goods in the REF mode	37

Normal refund transaction	37
Reduction of amounts paid on refund	37
Registering money received on account	38
Registering money paid out	38
Making corrections in a registration	39
To correct an item you input but not yet registered	39
To correct an item you input and registered	40
To correct the item you registered previously in this receipt	41
To cancel all items in a transaction	41
No sale registration	41
Printing the daily sales reset report	42
Procedure	42
Printout (by optional remote printer)	43
Advanced Operations	44
Post-finalization receipt	44
Inputting the number of customers	45
Clerk interrupt function	46
Printing slip	47
Printing slips	47
To perform auto batch printing 1	47
To perform auto batch printing 2	48
About the maximum number of slip lines	48
Check tracking systems	48
Check tracking system	48
Opening a check	49
Adding to a check	49
Issuing a guest receipt	50
Closing a check memory	50
New/old check key operation	51
Add check	52
Separate check	53
Clerk transfer	54
Table transfer	54
Condiment/preparation PLUs	55
Text recall	55
Deposit registrations	56
Deposit from customer	56
Deposit from customer during sales transaction	56
List-# registrations	56
Bill copy	57
Tray total	58
Multiple item totalling function	58
Set menu	59
Tips	59
Stock check	60

Introduction & Contents

Actual stock quantity inquiry	60
Single item cash sales	61
Addition	62
Addition (plus)	62
Premium (%+)	62
Coupon transactions	63
Coupon registration using <COUPON> (coupon key)	63
Coupon registration using <CPN2> (coupon 2 key)	63
Registering the second unit price	64
Preset tender amount	66
Arrangement key registrations	67
Currency exchange function	68
Registering foreign currency	68
Full amount tender in a foreign currency	68
Partial tender in a foreign currency	69
Temporarily releasing compulsion	70
VAT breakdown printing	71
Registering loan amounts	72
Registering pick up amounts	72
Changing media in drawer	72
Scanning PLU	73
Item registration	73
Unit price inquiry	73
Programming to clerk	74
Programming procedure	74
Programming descriptors and messages	75
Programming item descriptor (flat-PLU) procedure	75
Programming function key character procedure	76
Programming receipt/slip message procedure	77
Entering characters	78
Entering characters	78
Editing characters	80
Correcting a character just entered	80
Correcting and adding/deleting an item descriptor already set	80
Printing read/reset reports	81
The tree of X/Z menu window	81
To print the individual key (department, subdepartment, PLU/flat-PLU, function) read report	82
Procedure	82
Report (by optional remote printer)	82
To print the financial read report	83
Procedure	83
Report (by optional remote printer)	83
To print the individual clerk read/reset report	84
Procedure	84
Report (by optional remote printer)	84

To print the daily sales read/reset report	85
To print the periodic 1/2 sales read/reset reports	85
Procedure	85
Report (by optional remote printer)	85
To print the PLU read/reset report	86
Procedure	86
Report (by optional remote printer)	86
To print the hourly sales read/reset report	87
Procedure	87
Report (by optional remote printer)	87
To print the monthly sales read/reset report	88
Procedure	88
Report (by optional remote printer)	88
Reading the terminal's program	89
The tree of P6 (program read) menu window	89
Procedure	90
Report example	90
Unit price and quantity	90
Item descriptor	91
Character and Message	92
Clerk	92
Key feature	92
Troubleshooting	94
When an error occurs	94
When the terminal does not operate at all	97
In case of power failure	98
Options	98
Specifications	99
Index	100

Introducing QT-6000

General guide

This part of the manual introduces you to the terminal and provides a general explanation of its various parts.

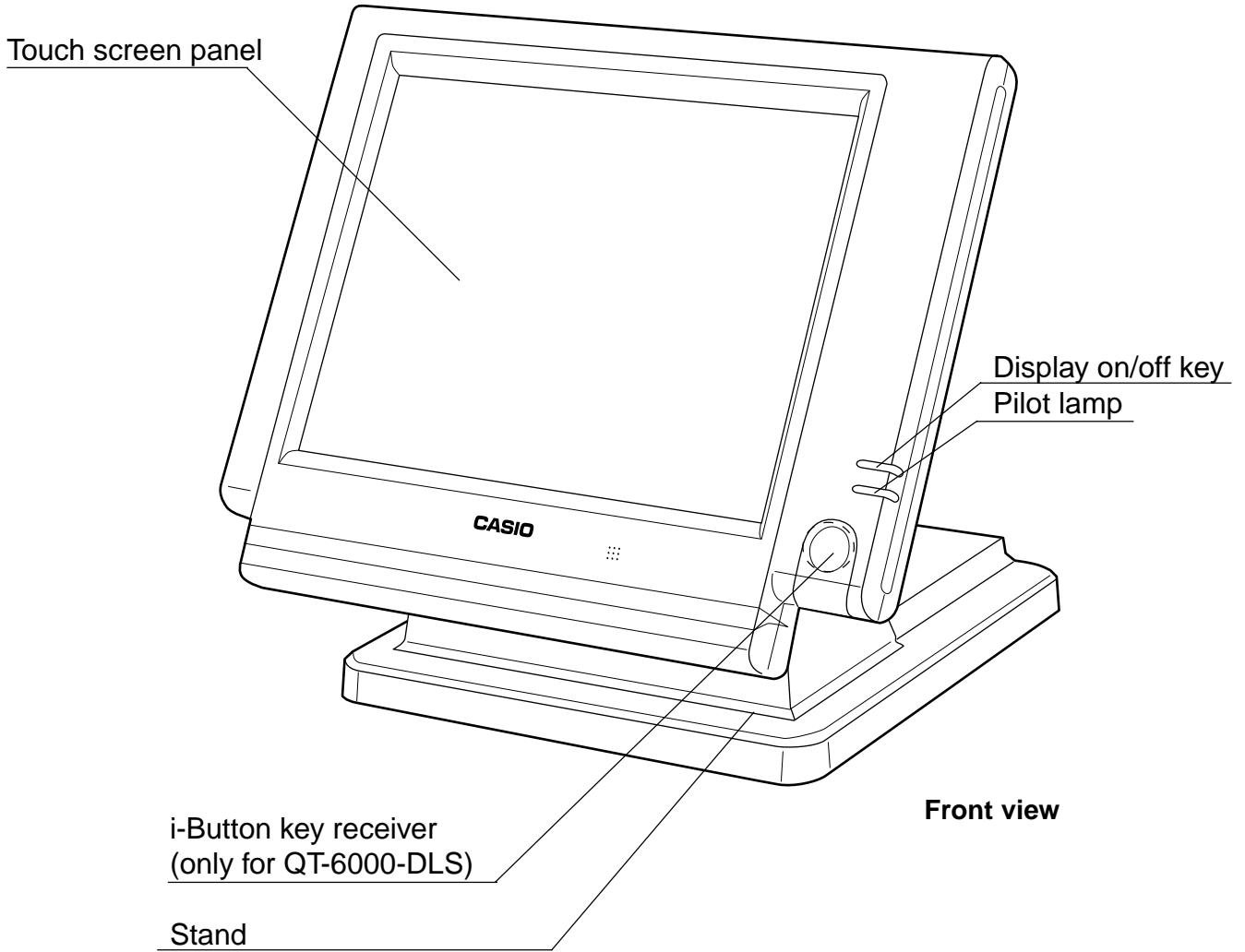

Accessories

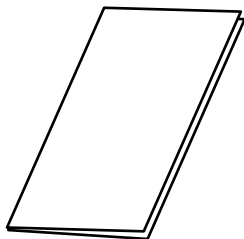

Dust cover



Drawer fixing screws

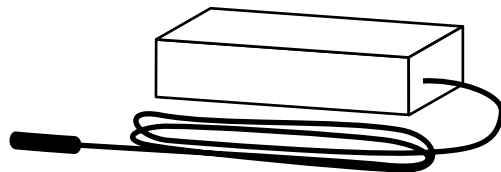

AC adaptor

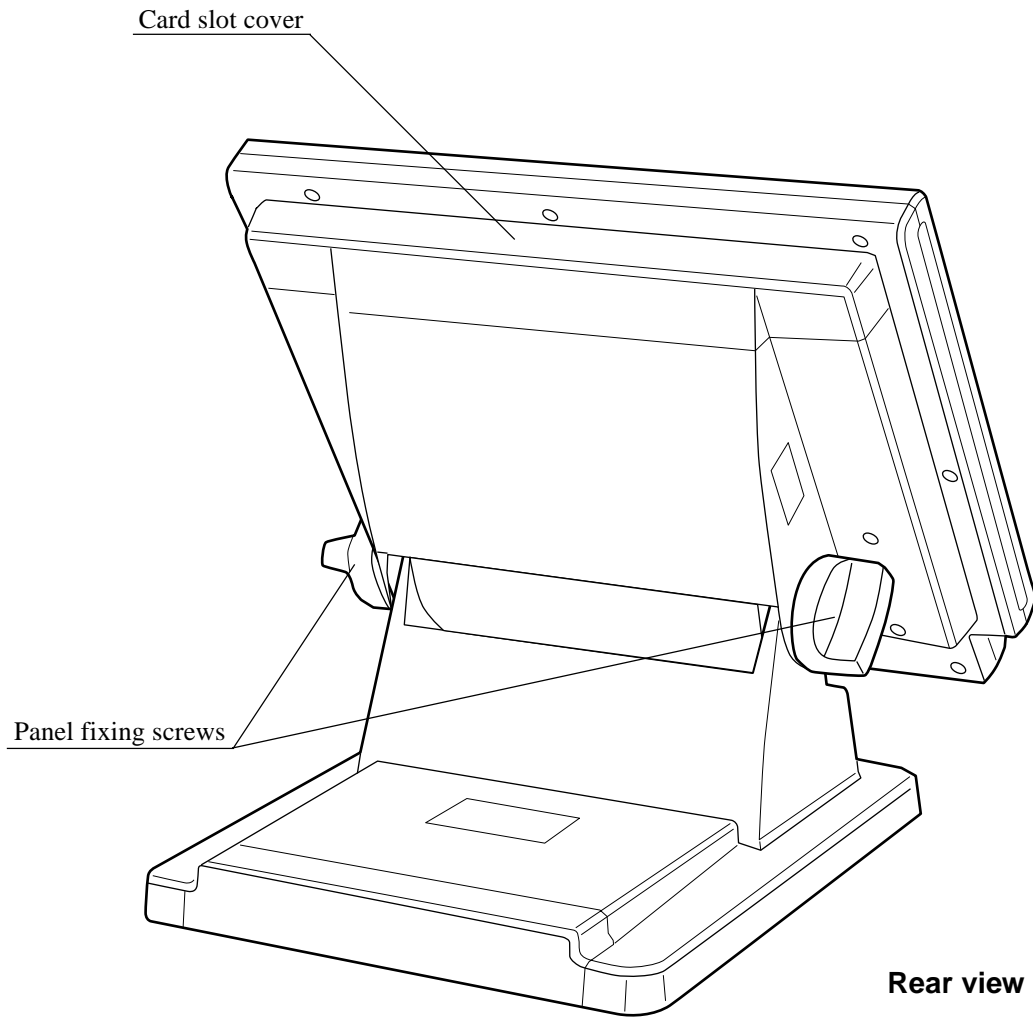

Tilt the touch screen panel

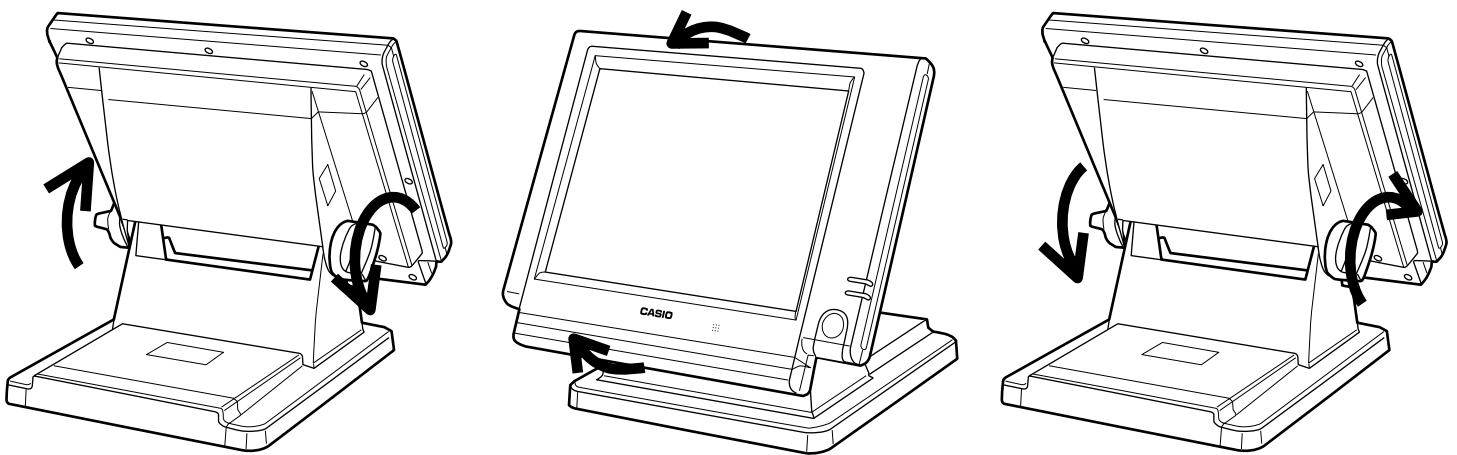

1. Loosen the panel fixing screws.
(Turn the screw more than one round.)
2. Tilt the touch screen panel.
3. Tighten the panel fixing screws.

Important!

Do not tilt without loosening the screws.

Introducing QT-6000

Display on/off key

This key is used for turning on/off the terminal display.

i-Button key (only for QT-6000-DLS)

You can assign the clerk or cashier by attaching an i-Button key to the receiver.

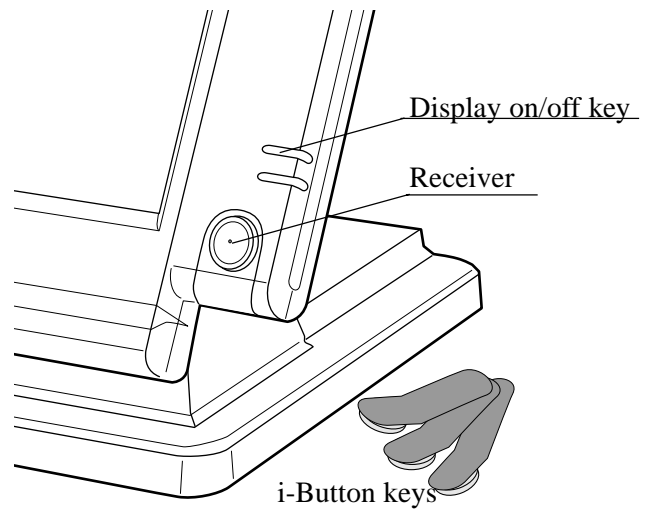

Drawer (option)

The drawer opens automatically whenever you finalize a registration and you issue a read or reset report.

Drawer lock (for medium size drawer)

Use the drawer key to lock and unlock the drawer.

Drawer open key (for large size drawer)

Use the drawer open key to open the drawer.

When the cash drawer does not open! (for medium size drawer only)

In case of power failure or the machine is in malfunction, the cash drawer does not open automatically. Even in these cases, you can open the cash drawer by pulling drawer release lever (see below).

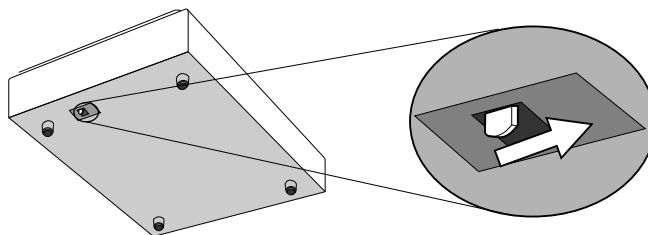

Important!

The drawer will not open, if it is locked with a drawer lock key.

Touch screen panel

You can use this panel both for display and for keyboard.

- This panel consists of 2 parts; display part and keyboard part.
- ① Main display part: Used for displaying numeric entries, registration, subtotal amount, etc.
- ② Menu level display part: Used for displaying the current shift PLU, menu sheet and 2nd unit price level.
- ③ Keyboard part: Mainly used for keyboard (sometimes it is used for pop-up window)

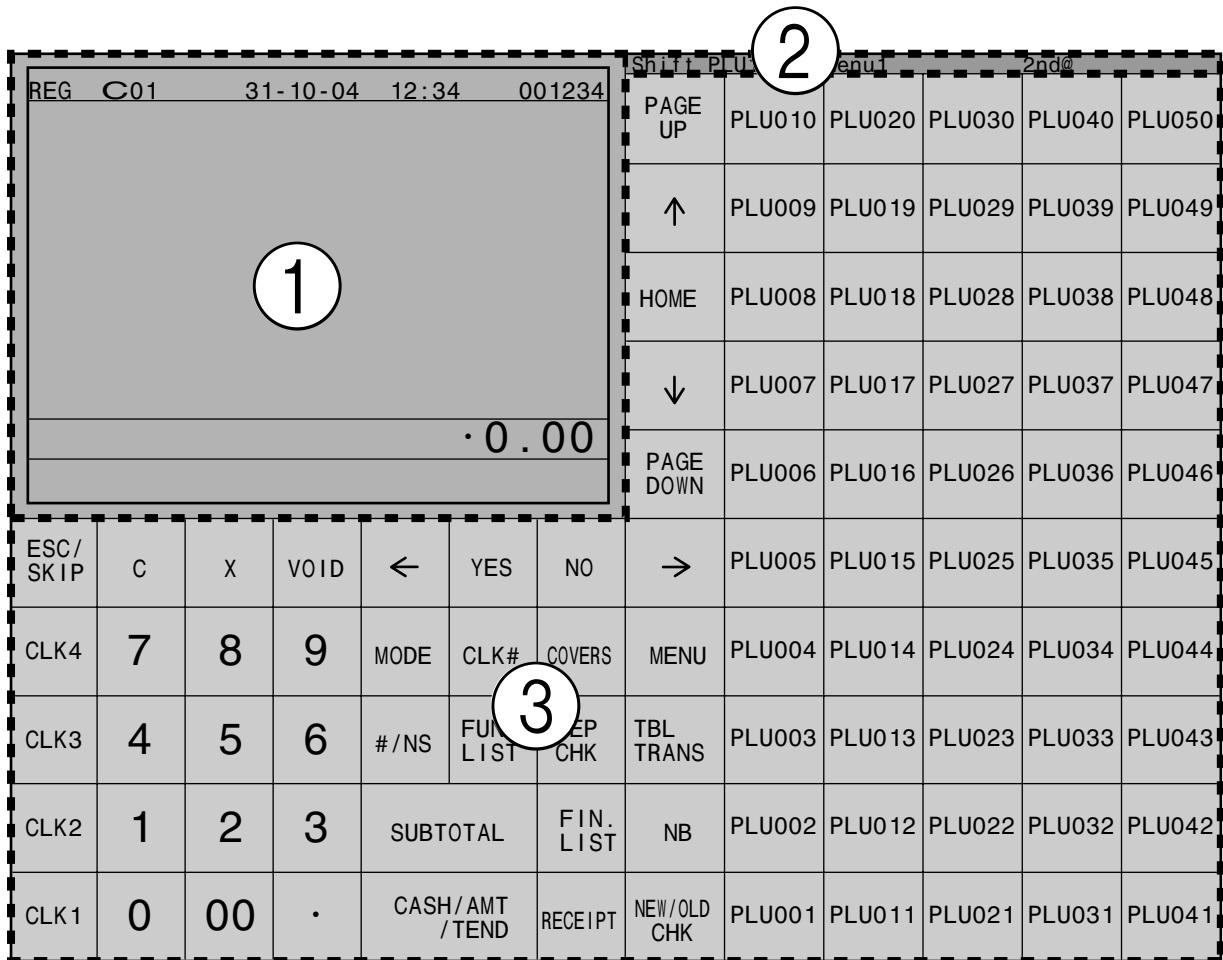

Note:

Use only your fingers to perform screen operations. Never use pencil, a mechanical pencil, or any other pointed object. Such objects can damage the screen.

Introducing QT-6000

Main display part

Mode	Clerk	Date	Time	Consecutive number
REG	C01	31-10-04	12:34 PM	001234
1	Spagetti		·20.00	T1
1	Spagetti		·20.00	T1
	7.5%			
	%-		-1.75	T1
1	Coffee		·8.00	
1	Hamburger		·2.00	T1
	15%			
	%-		-0.30	T1
1	Milk		·2.00	
2	Apple Juice		·5.00	
1	Coffee		·8.00	!
Spagetti			·20.00	
12			·76.50	
Status Icons	Items sold	Amount (total/change)		

Scroll area

Current transaction

- Communication: 
- Master/BM error: 
- Cut off Master or BM: 
- Receipt on: 
- Character size:
 - Double size: 
 - Standard size: 

Menu level display part

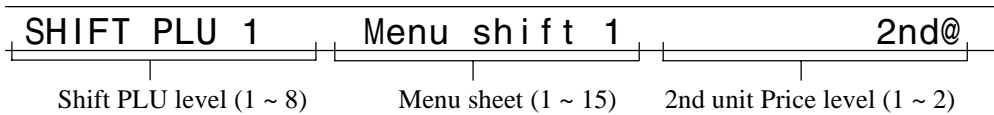

Main display part example

Normal registration

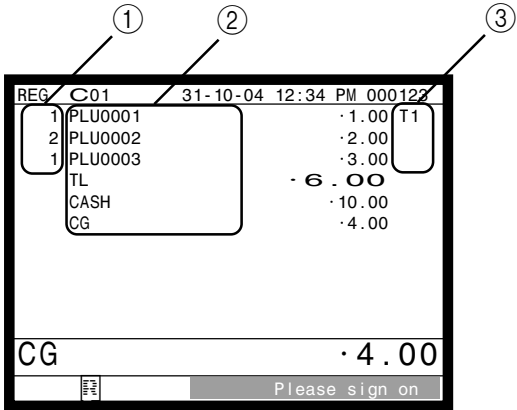

① **Registered item quantity**

This part of the display shows item count of each item.

② **Item/key descriptor**

When you register a department/PLU/scanning PLU or transaction key, the item descriptor or key descriptor appears here.

③ **Tax status**

When you register a taxable item, the corresponding tax status appears here by programming.

Check tracking registration

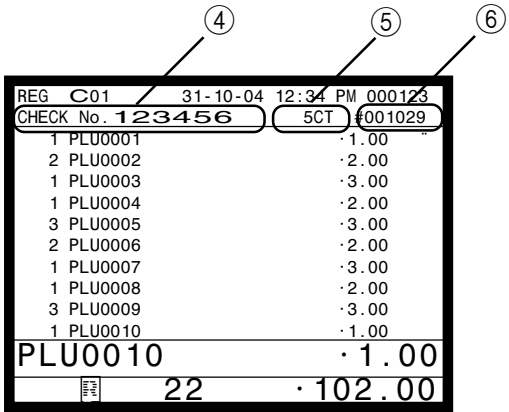

④ **Check number**

When you enter a check number, it appears here.

⑤ **Number of customer**

When you enter number of customers, it appears here.

⑥ **Table number**



When you enter a table number, it appears here.

Keyboard part

REG C01 31-10-04 12:34 PM 001234										19	26										
											PAGE UP	PLU010	PLU020	PLU030	PLU040	PLU050					
											7	↑	PLU009	PLU019	PLU029	PLU039	PLU049				
											20	HOME	PLU008	PLU018	PLU028	PLU038	PLU048				
											7	↓	PLU007	PLU017	PLU027	PLU037	PLU047				
											21	PAGE DOWN	PLU006	PLU016	PLU026	PLU036	PLU046				
											7	→	PLU005	PLU015	PLU025	PLU035	PLU045				
1	2	3	4	5	6	7	8	9	10	11	12	13	14	15	16	17	18	19	20	21	22
ESC/SKIP	C	X	VOID	←	YES	NO	→	PLU005	PLU015	PLU025	PLU035	PLU045									
CLK4	7	8	9	MODE	CLK#	COVERS	MENU	PLU004	PLU014	PLU024	PLU034	PLU044									
CLK3	4	5	6	#/NS	FUNC LIST	SEP CHK	TBL TRANS	PLU003	PLU013	PLU023	PLU033	PLU043									
CLK2	1	2	3	SUBTOTAL	FIN. LIST	NB		PLU002	PLU012	PLU022	PLU032	PLU042									
CLK1	0	00	.	CASH/AMT /TEND	RECEIPT	NEW/OLD CHK		PLU001	PLU011	PLU021	PLU031	PLU041									

• Register Mode







- ① **ESC/SKIP key** 

Use this key to terminate a program sequence, X/Z sequence, and return the primary status. This key is also used to terminate a report being issued in PGM, X, and Z mode.
- ② **Clerk key** ,  ~ 

Use this key to sign clerk on and off the terminal.





Clerk number key 

Use this key to sign clerk on and off the terminal by clerk number.
- ③ **Clear key** 

Use this key to clear an entry that has not yet been registered.
- ④ **Ten key pad** ,  ~ , , 
- ⑤ **Multiplication/Date/Time key** 

Use this key to input a quantity for a multiplication operation. Between transactions, this key displays the current time and date.
- ⑥ **Error correct/Void key** 

Use this key to correct the last registered item, discount, premium, amount tendered etc. This key also invalidates proceeding data registered for PLUs or set menus etc.
- ⑦ **Left, right, up, down arrow key**

, , , 















Use these keys to move the cursor.
- ⑧ **Mode key** 

Use this key to change mode. This key shows the allowable mode keys in the pop-up window.
- ⑨ **Non-add/No sale key** 

Non-add key: To print reference number (to identify a personal check, credit card, etc.) during a transaction, use this key after some numerical entries.

No sale key: Use this key to open the drawer without registering anything.
- ⑩ **Subtotal key** 

Use this key to display and print the current subtotal (includes add-on tax) amount.

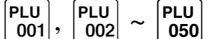
- ⑪ **Cash/Amount tendered key**  Use this key to register a cash tender.
- ⑫ **Yes key**  Use this key to consent the selection and proceeding steps.
- ⑬ **Function list key**  Use this key to show the programmed function key list. Use this key to register the function key which is not located on the keyboard but assigned in the memory.
- ⑭ **No key**  Use this key to cancel the selection and proceeding steps.
- ⑮ **Number of customer key**  Use this key to register the number of customers.
- ⑯ **Separate check key**  Use this key in a check tracking system to separate selected items from one check to another check. If this key is registered, a pop-up window for separating a check is opened.
- ⑰ **Finalization list key**  Use this key to show the programmed finalization key list. Use this key to register the finalization key which is not located on the keyboard but assigned in the memory.
- ⑱ **Post receipt key**  Use this key to produce a post-finalization receipt.
- ⑲ **Page up key**  Use this key to turn the window forwards.
- ⑳ **Home position key**  Use this key to return the cursor to the home position.
- ㉑ **Page down key**  Use this key to turn the window backwards.
- ㉒ **Menu shift key**  Use this key to shift Flat-PLU key to n-th (1 ~ 15) menu.
- ㉓ **Table transfer key**  Use this key to transfer the contents of a check to another check.
- ㉔ **New balance key**  Use this key to add the current registered total amount to the previous balance to obtain a new balance. When this key is pressed, the total amount of the transaction is calculated. Normally, a receipt is issued.
- ㉕ **New/Old check key**  Use this key in a check tracking system to input check numbers in order to open new checks and to reopen existing checks. When the clerk inputs a check number, the register checks to see if that number already exists in the check tracking memory. If there is no matching number in the memory, a new check is opened under the input number. If the check number matches a number already stored in the memory, that check is reopened for further registration or finalization.
- ㉖ **Flat-PLU key**  Use these keys to register items to flat-PLUs.

Introducing QT-6000

Keyboard part with pop-up window

List pop-up window

REG C01 31-10-04 12:34 PM 001234								Shift PLU1 Menu1 2nd@																																													
<div style="border: 1px solid black; padding: 5px; margin-bottom: 5px;"> · 0.00 </div>								PAGE UP	FUNC LIST <table border="1" style="width: 100%; border-collapse: collapse;"> <tr><td>SEAT#</td><td>CANCEL</td></tr> <tr><td>ADDCHK</td><td>-</td></tr> <tr><td>VAT</td><td>%-</td></tr> <tr><td>MEDIA CHG</td><td>RC</td></tr> <tr><td>RCT ON/OFF</td><td>PD</td></tr> </table>		SEAT#	CANCEL	ADDCHK	-	VAT	%-	MEDIA CHG	RC	RCT ON/OFF	PD																																	
								SEAT#			CANCEL																																										
								ADDCHK			-																																										
								VAT			%-																																										
MEDIA CHG	RC																																																				
RCT ON/OFF	PD																																																				
↑																																																					
HOME																																																					
↓																																																					
<table border="1" style="width: 100%; border-collapse: collapse;"> <tr><td>ESC/SKIP</td><td>C</td><td>X</td><td>VOID</td><td>←</td><td>YES</td><td>NO</td><td>→</td></tr> <tr><td>CLK4</td><td>7</td><td>8</td><td>9</td><td>MODE</td><td>CLK#</td><td>COVERS</td><td>MENU</td></tr> <tr><td>CLK3</td><td>4</td><td>5</td><td>6</td><td>#/NS</td><td>FUNC LIST</td><td>SEP CHK</td><td>TBL TRANS</td></tr> <tr><td>CLK2</td><td>1</td><td>2</td><td>3</td><td colspan="2">SUBTOTAL</td><td>FIN. LIST</td><td>NB</td></tr> <tr><td>CLK1</td><td>0</td><td>00</td><td>.</td><td colspan="2">CASH/AMT /TEND</td><td>RECEIPT</td><td>NEW/OLD CHK</td></tr> </table>								ESC/SKIP	C	X	VOID	←	YES	NO	→	CLK4	7	8	9	MODE	CLK#	COVERS	MENU	CLK3	4	5	6	#/NS	FUNC LIST	SEP CHK	TBL TRANS	CLK2	1	2	3	SUBTOTAL		FIN. LIST	NB	CLK1	0	00	.	CASH/AMT /TEND		RECEIPT	NEW/OLD CHK	PAGE DOWN	How to Cook 0/1-1 <table border="1" style="width: 100%; border-collapse: collapse;"> <tr><td>Rare</td></tr> <tr><td>Medium</td></tr> <tr><td>Well done</td></tr> </table>		Rare	Medium	Well done
								ESC/SKIP	C	X	VOID	←	YES	NO	→																																						
								CLK4	7	8	9	MODE	CLK#	COVERS	MENU																																						
								CLK3	4	5	6	#/NS	FUNC LIST	SEP CHK	TBL TRANS																																						
CLK2	1	2	3	SUBTOTAL		FIN. LIST	NB																																														
CLK1	0	00	.	CASH/AMT /TEND		RECEIPT	NEW/OLD CHK																																														
Rare																																																					
Medium																																																					
Well done																																																					
↑																																																					
HOME																																																					
↓																																																					
<table border="1" style="width: 100%; border-collapse: collapse;"> <tr><td>NB</td><td>PLU002</td><td>PLU012</td><td>PLU022</td><td>PLU032</td><td>PLU042</td></tr> <tr><td>PLU001</td><td>PLU011</td><td>PLU021</td><td>PLU031</td><td>PLU041</td><td></td></tr> </table>								NB	PLU002	PLU012	PLU022	PLU032	PLU042	PLU001	PLU011	PLU021	PLU031	PLU041		MENU	Staydown counters (registered/minimum maximum numbers)																																
								NB	PLU002	PLU012	PLU022	PLU032	PLU042																																								
								PLU001	PLU011	PLU021	PLU031	PLU041																																									
								→																																													
BL RANS																																																					
→																																																					

Check number pop-up window

REG C01 31-10-04 12:34 PM 001234								Shift PLU1 Menu1 2nd@																																																										
<div style="border: 1px solid black; padding: 5px; margin-bottom: 5px;"> · 0.00 </div>								PAGE UP	Select Check/Table number <table border="1" style="width: 100%; border-collapse: collapse;"> <tr><td>#1 -1.45</td><td>#2 -23.00</td></tr> <tr><td>#3 -76.45</td><td>#4 -7.00</td></tr> <tr><td>#5 -1.95</td><td>#6 -8.01</td></tr> <tr><td>#7 -231.45</td><td>#9 -4.00</td></tr> <tr><td>#12 -2,356.45</td><td>#17 -9.98</td></tr> <tr><td>#18 -103.00</td><td>#20 -8.00</td></tr> <tr><td>Next</td><td>Prev</td><td>Rcpt</td><td>Esc</td></tr> </table>		#1 -1.45	#2 -23.00	#3 -76.45	#4 -7.00	#5 -1.95	#6 -8.01	#7 -231.45	#9 -4.00	#12 -2,356.45	#17 -9.98	#18 -103.00	#20 -8.00	Next	Prev	Rcpt	Esc																																								
								#1 -1.45			#2 -23.00																																																							
								#3 -76.45			#4 -7.00																																																							
								#5 -1.95			#6 -8.01																																																							
#7 -231.45	#9 -4.00																																																																	
#12 -2,356.45	#17 -9.98																																																																	
#18 -103.00	#20 -8.00																																																																	
Next	Prev	Rcpt	Esc																																																															
↑																																																																		
HOME																																																																		
↓																																																																		
<table border="1" style="width: 100%; border-collapse: collapse;"> <tr><td>ESC/SKIP</td><td>C</td><td>X</td><td>VOID</td><td>←</td><td>YES</td><td>NO</td><td>→</td></tr> <tr><td>CLK4</td><td>7</td><td>8</td><td>9</td><td>MODE</td><td>CLK#</td><td>COVERS</td><td>MENU</td></tr> <tr><td>CLK3</td><td>4</td><td>5</td><td>6</td><td>#/NS</td><td>FUNC LIST</td><td>SEP CHK</td><td>TBL TRANS</td></tr> <tr><td>CLK2</td><td>1</td><td>2</td><td>3</td><td colspan="2">SUBTOTAL</td><td>FIN. LIST</td><td>NB</td></tr> <tr><td>CLK1</td><td>0</td><td>00</td><td>.</td><td colspan="2">CASH/AMT /TEND</td><td>RECEIPT</td><td>NEW/OLD CHK</td></tr> </table>								ESC/SKIP	C	X	VOID	←	YES	NO	→	CLK4	7	8	9	MODE	CLK#	COVERS	MENU	CLK3	4	5	6	#/NS	FUNC LIST	SEP CHK	TBL TRANS	CLK2	1	2	3	SUBTOTAL		FIN. LIST	NB	CLK1	0	00	.	CASH/AMT /TEND		RECEIPT	NEW/OLD CHK	PAGE DOWN	Select Check/Table number <table border="1" style="width: 100%; border-collapse: collapse;"> <tr><td>#1 -1.45</td><td>☀</td></tr> <tr><td>☀</td><td>#2 -7.00</td></tr> <tr><td>#3 -1.95</td><td>#4 -8.01</td></tr> <tr><td>#5 -231.45</td><td>#6 -4.00</td></tr> <tr><td>#7 -2,356.45</td><td>☀</td></tr> <tr><td>#8 -103.00</td><td>#9 -8.00</td></tr> <tr><td>Next</td><td>Prev</td><td>Rcpt</td><td>Esc</td></tr> </table>		#1 -1.45	☀	☀	#2 -7.00	#3 -1.95	#4 -8.01	#5 -231.45	#6 -4.00	#7 -2,356.45	☀	#8 -103.00	#9 -8.00	Next	Prev	Rcpt	Esc
								ESC/SKIP	C	X	VOID	←	YES	NO	→																																																			
								CLK4	7	8	9	MODE	CLK#	COVERS	MENU																																																			
								CLK3	4	5	6	#/NS	FUNC LIST	SEP CHK	TBL TRANS																																																			
CLK2	1	2	3	SUBTOTAL		FIN. LIST	NB																																																											
CLK1	0	00	.	CASH/AMT /TEND		RECEIPT	NEW/OLD CHK																																																											
#1 -1.45	☀																																																																	
☀	#2 -7.00																																																																	
#3 -1.95	#4 -8.01																																																																	
#5 -231.45	#6 -4.00																																																																	
#7 -2,356.45	☀																																																																	
#8 -103.00	#9 -8.00																																																																	
Next	Prev	Rcpt	Esc																																																															
↑																																																																		
HOME																																																																		
↓																																																																		
<table border="1" style="width: 100%; border-collapse: collapse;"> <tr><td>NB</td><td>View-1</td><td>View-2</td><td>View-3</td><td>View-4</td></tr> </table>								NB	View-1	View-2	View-3	View-4	MENU	Add-on new number type Show table layout type																																																				
								NB	View-1	View-2	View-3	View-4																																																						
								→																																																										
								BL RANS																																																										
→																																																																		

Allocatable functions

You can tailor a keyboard to suit your particular type of business.

Consult your CASIO dealer for detail information.

Add check

Use this key in a check tracking system to combine the details of more than one check into a single check.

Arrangement

Use this key to activate an arrangement program programmed in the arrangement file. Any operation that can be performed from the keyboard, as well as mode, can be programmed in an arrangement program, and can be performed merely by pressing this key. In addition, one numeric entry can be included in an arrangement program. In this case, input the number and press this key. The mode control function of this key can be programmed for all modes except for the OFF mode.

Bill copy

Use this key to issue bill copy.

Break-in/out

Use this key to register the starting/finishing time when employees have a recess.

Charge

Use this key to register a charge sale.

Check

Use this key to register a check tender.

Check endorsement

Use this key to print a preset check endorsement message using the slip printer.

Check print

Use this key to print the check on the slip printer.

Clerk number

Use this key to assign a clerk's secret number.

Clerk transfer

Use this key to transfer opened checks to another clerk.

Clock-in/out

Use this key to register the time when the employees start/finish their job.

Coupon

Use this key for registering coupons.

Coupon number

Use this key for registering mix and match discount by entering coupon number.

Coupon 2

Use this key to declare the next item registration as coupon.

Credit

Use this key to register a credit sale.

Cube

This key provides the same functions as the Square key. In addition, this key also has a cube multiplication function.

Currency exchange

Use this key to convert foreign currency to local currency or vice versa using the exchange rate preset for the key and displays the result.

Use this key for conversions of a home currency subtotal or merchandise subtotal to equivalent of another country's currency.

Use this key for conversions of another country's currency to the equivalent of the home currency.

Customer ID number

Use this key to enter customer ID number.

Declaration

Use this key to declare in drawer amount for money declaration.

Department

Use this key to register department.

Department number

Use this key to enter department number.

Deposit

Use this key to register deposits.

Discount

Use this key to register discounts.

Display mode

Use this key to choose item consolidation display format or non-item consolidation display format.

Dutch account

Use this key to share the total payment by customers.

Eat-in

Use this key to specify if the customer eats in the restaurant. Before closing a transaction press this key.

EBT (electronic benefit transfer)

Use this key to register an EBT amount with a tender amount input.

Electronic journal display

Use this key to display the stored journal.

Euro/Paid out

Euro key: Use this key to convert the main currency to the sub currency (the euro/the local money), when registering the subtotal amount. This key is also used for specifying sub currency while entering an amount of payment.

Paid out key: Use this key following a numeric entry to register money paid out from the drawer.

1st unit price

Use this key to register a specific item at the first unit price.

Food stamp shift

Use this key to change food stamp status.

Food stamp subtotal

Use this key to obtain the food stamp applicable amount.

Food stamp tender

Use this key to register a food stamp payment amount with a tender amount input.

House Bon

Use this key to register items for in-store use.

Item search

Use this key to search an item by its name.

Introducing QT-6000

List

Use this key to display menu lists.

List number

Use this key to enter list number.

Loan

Use this key to input the amount of money provided making change.

Location change

Use this key to select the window which shows the table layout of each floor/part of the restaurant.

Ketten Bon

Use this key to enter quantities for multiplication. Multiplication by this key issues singular order prints.

Media change

Use this key to change media in drawer amounts.

Merchandise subtotal

Use this key to obtain subtotal excluding the add-on tax amount and the previous balance.

Minus

Use this key register subtraction.

New check

Use this key in a check tracking system to input a new check number in order to open a new check under that number.

No sale

Use this key to open the drawer between transaction.

Non-add

Use this key to print reference numbers (personal check number, card number, etc.)

Normal receipt

Use this key to change the order status from Bon to normal.

OBR (Optical barcode reader)

Use this key to input optical barcodes manually.

Old check

Use this key in a check tracking system to input the number of an existing check (previously created by the New check key) whose details are stored in the check tracking memory. Existing checks are reopened to perform further registration or to finalize them.

Open

Use this key to temporary release a limitation on the number of digits that can be input for a unit price.

Open 2

Use this key to suspend the compulsory specifications.

Open check

Use this key to issue an open check report of an assigned clerk.

Operator number

Use this key to enter a clerk number during clerk transfer.

Operator X/Z

Use this key to issue a clerk's individual X/Z report.

Order character change

Use this key to change the order character. The order characters not only of the item but in the order character table can be printed.

Payment

Use this key to declare the following transactions as payment.

PLU number

Use this key to enter PLU number.

Plus

Use this key for registering surcharge.

Pick up

Use this key to pick up media in drawer.

Premium

Use this key to apply a preset % or manual input % to obtain the premium amount for the last registered item or subtotal.

Price

Use this key to register an open PLU.

Price inquiry

Use this key to confirm the price and descriptors of PLU without registering.

Price shift

Use this key to shift a PLU item/flat-PLU key to the 1st ~ 2nd unit price, a scanning PLU to the 1st ~ 3rd unit price.

Post entry

Use this key to indicate the reserved item of set menu and register it as a fixed item later on.

Post receipt

Use this key to produce a post-finalization receipt.

Quantity/for

This key provides the same functions as the multiplication key. In addition, this key also has a split price function.

Recall

Use this key for recalling the transferred check number by the store key. When this key is pressed, the check number will appear in order of the oldest record.

Receipt on/off

Use this key to change the setting "Receipt issue"/"No receipt issue" in REG/REF/REG- modes. This key should be pressed twice.

Received on account

Use this key following a numeric entry to register money received for non-sale transaction.

Refund

Use this key to input refund amounts and void certain entries.

Round repeat

Use this key to register the same items which were ordered just before.

Seat number

Use this key to enter and print seat number.

2nd unit price

Use this key to register a specific item at the second unit price.

Separate check

Use this key in a check tracking system to separate selected items from one check to another check.

Selective item subtotal

Use this key to obtain the selective item 1/2 of subtotal amount.

Shift PLU

Use this key to shift flat-PLU key to the n-th (1 ~ 8) level.

Slip feed/release

Use this key to feed slips inserted into the slip printer. This is done by specifying the number of feed lines. This key is also used to release the slip paper holder if numbers are not entered.

Slip back feed/release

Use this key to back feed slips inserted into the slip printer. This is done by specifying the number of feed lines. This key is also used to release the slip paper holder if numbers are not entered.

Slip print

Use this key to execute a slip batch printing on the slip printer. Pressing this key prints the sales details. Actual printing is performed following receipt issuance.

Square

This key provides the same functions as the Multiplication key. In addition, this key also has a square multiplication function.

Stock inquiry

Use this key to check the current stock quantity for a PLU without registering.

Store

Use this key for storing the check number of the registered items. When this key is pressed, registered item data will be stored, and then these data will transfer to the youngest check number.

Subdepartment

Use this key to register items for the subdepartment.

Subdepartment number

Use this key to enter subdepartment number.

Substitution

Use this key to replace group PLU with a PLU which is not preset in the pulldown menu.

Table number

Use this key to input table numbers.

Table sharing

Use this key to assign one table to two or more customer groups.

Takeout

Use this key to specify if the customer takes out items, before total a transaction. Press this key for the tax exemption.

Tax exempt

Use this key to change taxable amounts to nontaxable amounts.

Tax shift

Use this key to activate the tax table which is specified by the same tax status programmed for this key.

Taxable amount subtotal

Use this key to obtain taxable amount subtotal.

Text print

Use this key to enter characters to print.

Text recall

Use this key to print preset characters.

Tip

Use this key to register tips.

Tray total

Use this key to display the total amount for all registrations from the last registration until this key is pressed or registrations between presses of this key.

Validation

Use this key to validate item or transaction amounts on the slip.

VAT

Use this key to print VAT breakdowns.

Keys in check No. pop-up window

Special function keys to control check No. pop-up window are located at the bottom of the screen.

Next (Page up)

Use this key to turn the pop-up window forwards.

Previous (Page down)

Use this key to turn the pop-up window backwards.

Escape

Use this key to terminate the operation of the pop-up window and close it.

View-1 ~ View-4 (Location change)

Use this key to select the pop-up window which shows the table layout of each floor/part of the restaurant.

How to use the terminal

The following describes the general procedure you should use in order to get the most out of the terminal.

BEFORE business hours...

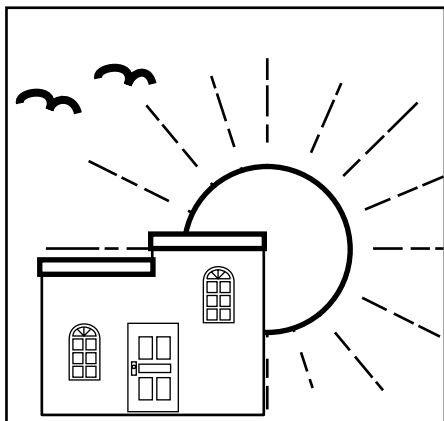

- Check to make sure that the terminal is plugged in securely.
- Check to make sure there is enough paper left on the roll of the remote printer.
- Read the financial totals to confirm that they are all zero.
- Check the date and time.

Page 83

Page 25

DURING business hours...

- Register transactions.
- Periodically read totals.

Page 26 ~

Page 81

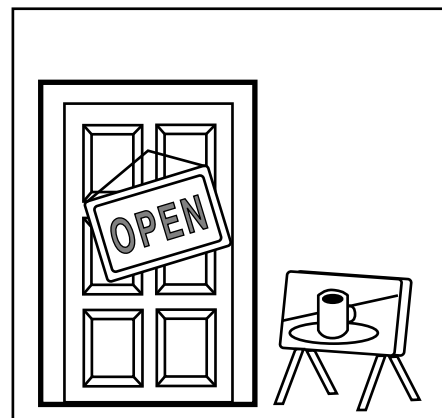

AFTER business hours...

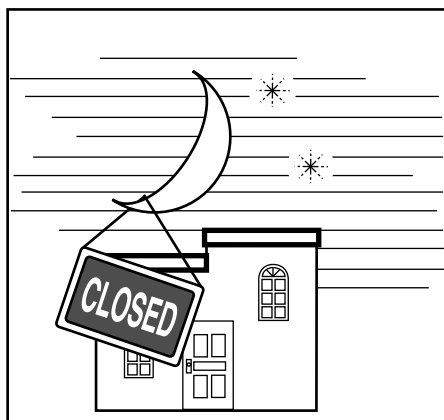

- Reset the daily totals.
- Read the electronic journal.
- Empty the cash drawer and leave it open.
- Take the cash to the office.

Page 42

Page 81

Page 12

Clerk sign on/off and mode change

Assigning a clerk



In Germany, you can assign clerks by attaching an i-Button key to the receiver or by clerk number.

In other areas, you can assign clerks by using clerk key or by clerk secret number. The method you use for assigning clerk depends on the programming of the terminal.

Clerk key

You can assign the clerk or cashier using the four (thru) keys on the keyboard or clerk icon in the clerk pop-up window.

Clerk number key

The key is used for the clerk secret number key.

i-Button key

You can assign the clerk or cashier by attaching an i-Button key to the receiver.

Clerk sign on

	Clerk key	OPERATION Clerk number key	i-Button key
Signing clerk 1 on:	<input type="text" value="CLK1"/>	* <input type="text" value="1"/> <input type="text" value="CLK#"/>	attach i-Button key 1
Signing clerk 2 on:	<input type="text" value="CLK2"/>	* <input type="text" value="2"/> <input type="text" value="CLK#"/>	attach i-Button key 2
		⋮	⋮
Signing clerk 6 on:	--	* <input type="text" value="6"/> <input type="text" value="CLK#"/>	attach i-Button key 6

Clerk secret number
(1 ~ 6 is set as default.)

* If you do not want the clerk secret number to be shown on the display, press before entering the number.

Clerk sign off

	Clerk key	OPERATION Clerk number key	i-Button key
Signing clerk off:	<input type="text" value="0"/> <input type="text" value="CLK1"/> (~ <input type="text" value="CLK4"/>)	<input type="text" value="0"/> <input type="text" value="CLK#"/>	remove i-Button key

- The current clerk is also signed off whenever you turn off the terminal or finalize a transaction.

Important!

- A clerk cannot sign on unless other clerk is signed off.
- The signed on clerk is identified on the receipt/journal.

Basic Operations and Setups

Mode change

Even the mode switch is not allocated on the terminal, you can change the mode of the terminal by pressing the **MODE** key.

Mode pop-up window

When you press the **MODE** key, the mode pop-up window is appeared. In the mode pop-up window, only the allowable mode icons of the signed on clerk is appeared. You can change the mode of the terminal by pressing the mode icons in the mode pop-up window.

• When a manager signs on.

REG C01 31-10-04 12:34 PM 001234								Shift	PLU1	Menu1	2nd@
								PAGE UP	Select mode		
								↑	REG	RF	REG-
								HOME	REG2		
								↓	X/Z	Manager	InLine
· 0.00								PAGE DOWN	AUTO PGM	CF CARD	
									PGM1	PGM2	PGM3
ESC/SKIP	C	X	VOID	←	YES	NO	→				
CLK4	7	8	9	MODE	CLK#	COVERS	MENU				
CLK3	4	5	6	#/NS	FUNC LIST	SEP CHK	TBL TRANS				
CLK2	1	2	3	SUBTOTAL		FIN. LIST	NB				
CLK1	0	00	.	CASH/AMT/TEND		RECEIPT	NEW/OLD CHK				

Mode pop-up window

Mode icons

All available modes of the manager are displayed.

• When a clerk signs on

REG C01 31-10-04 12:34 PM 001234								Shift	PLU1	Menu1	2nd@
								PAGE UP	Select mode		
								↑	REG		
								HOME			
								↓	X/Z	InLine	
· 0.00								PAGE DOWN	PGM1		
ESC/SKIP	C	X	VOID	←	YES	NO	→				
CLK4	7	8	9	MODE	CLK#	COVERS	MENU				
CLK3	4	5	6	#/NS	FUNC LIST	SEP CHK	TBL TRANS				
CLK2	1	2	3	SUBTOTAL		FIN. LIST	NB				
CLK1	0	00	.	CASH/AMT/TEND		RECEIPT	NEW/OLD CHK				

Mode pop-up window

Mode icons

All available modes of the clerk are displayed.

Displaying the time and date

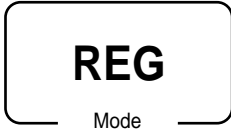

You can show the time or date on the display of the terminal whenever there is no registration being made.

To display and clear the date/time

OPERATION



Date/time appears on the display.

DISPLAY

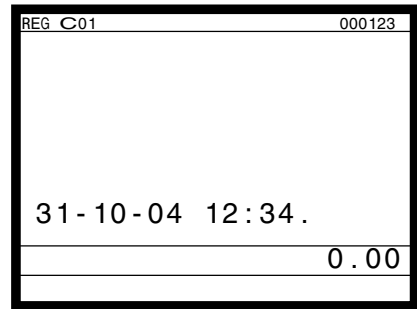

Clears the date/time display.

Adjusting the time and date

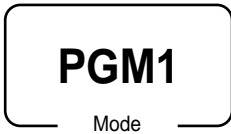

You can adjust the time or date in the PGM 1 mode.

To adjust the time

OPERATION



Press <MODE> key and press <PGM1> icon.



Enter the current time in 4 digits (hour, minutes order) and press the [X] key.



Clear the date/time display.

DISPLAY

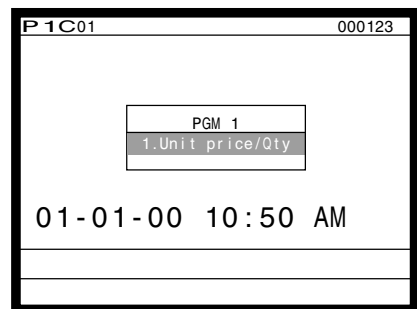

To adjust the date

OPERATION



Press <MODE> key and press <PGM1> icon.



Enter the current date in 6 digits (year, month, day order) and press the [X] key.



Clear the date/time display.

DISPLAY

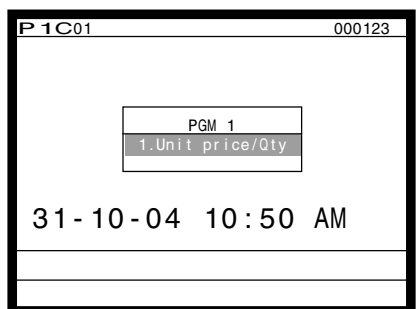

Preparing and using flat-PLU keys

Registering flat-PLU keys



The following examples show how you can use the flat-PLU keys in various types of registrations.

Single item sale

Example 1

OPERATION

PRINTOUT (by optional remote printer)

Item	Unit price	\$1.00
	Quantity	1
	Flat-PLU	1
Payment	Cash	\$1.00

1 00

Unit price

PLU 001

Flat-PLU

CA/AMT TEND

REG	C01	31-10-2004 09:05 AM 000002	MC #01
1	PLU001		.1.00
	TL		- 1.00
	CASH		.1.00

Machine No.
Mode/Clerk/Date/
Time/Consecutive No.
PLU No./unit price
Total amount

Example 2 (Subtotal registration and change computation)

OPERATION

PRINTOUT (by optional remote printer)

Item	Unit price	\$12.34
	Quantity	1
	Flat-PLU	1
Payment	Cash	\$20.00

1 2 3 4

Unit price

PLU 001

Flat-PLU

SUB TOTAL

2 0 00 **CA/AMT TEND**

Amount tendered

REG	C01	31-10-2004 09:10 AM 000003	MC #01
1	PLU001		.12.34
	TL		- 12.34
	CASH		.20.00
	CG		.7.66

Total amount
Amount tendered
Change

Repeat, menu shift

OPERATION

PRINTOUT (by optional remote printer)

Item 1	Unit price	\$1.50
	Quantity	3
	Flat-PLU	1
Item 2	Unit price	\$2.50
	Quantity	2
	Flat-PLU	51
Payment	Cash	\$10.00

1 5 0 **PLU 001**

PLU 001

PLU 001

MENU

2 5 0 **PLU 001**

PLU 001

SUB TOTAL

1 0 00 **CA/AMT TEND**

REG	C01	31-10-2004 09:15 AM 000004	MC #01
1	PLU001		.1.50
1	PLU001		.1.50
1	PLU001		.1.50
1	PLU051		.2.50
1	PLU051		.2.50
	TL		- 9.50
	CASH		.10.00
	CG		.0.50

Repeat
Repeat

Repeat

Multiplication

OPERATION PRINTOUT (by optional remote printer)

Item	Unit price	\$1.00
	Quantity	12
	Flat-PLU	1
Payment	Cash	\$20.00

1 2 X
 Quantity
 (4-digit integer/3-digit decimal)
1 00 PLU
001
SUB
TOTAL
2 0 00 CA/AMT
/TEND

		MC #01	
REG	C01	31-10-2004 09:20 AM	000005
12	PLU001		-12.00
			Quantity/result
or			
12		@1/ 1.00	
12	PLU001		-12.00
			Quantity/unit q'ty/@ Result
TL			- 12.00
CASH			-20.00
CG			-8.00

Programming to flat-PLU

Flat-PLU unit price programming procedure

- Step 1. Press MODE and <PGM1> icon to turn "PGM-1" and press YES.
- Step 2. Select "1.PLU" and press YES.

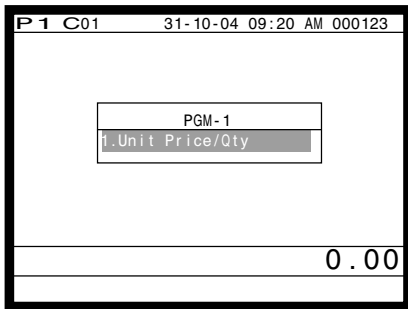

Step 1. screen

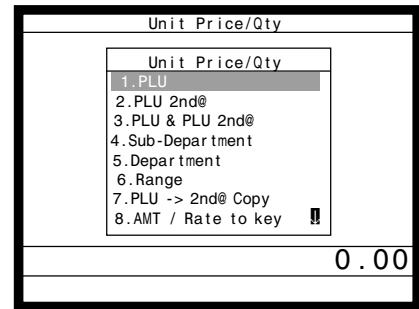

Step 2. screen

- Step 3. Select the PLU record you want to program by pressing the flat-PLU key directly, by entering PLU record No. and YES, or by entering random PLU code and PLU.
- Step 4. Enter appropriate unit price and YES.

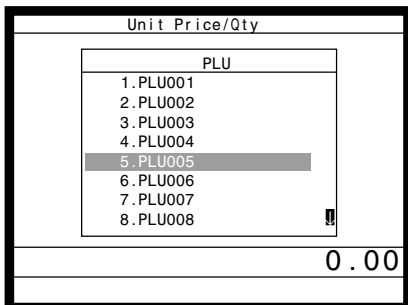

Step 3. screen

No.	Descriptor	Price
5	PLU005	@50.00
6	PLU006	@0.00
7	PLU007	@0.00
8	PLU008	@0.00
9	PLU009	@0.00
10	PLU010	@0.00
11	PLU011	@0.00
12	PLU012	@0.00
13	PLU013	@0.00
14	PLU014	@0.00
15	PLU015	@0.00
		0.00

Step 4. screen

- Step 5. Repeat the step 4., if you program the next record.
 Press ESC/SKIP and repeat the step 3. and 4., if you program to the other record.
- Step 6. Press ESC/SKIP repeatedly to return to the "Step 1. screen".

Basic Operations and Setups

Flat-PLU department link/tax status/listing capacity programming procedure

Step 1. Press **MODE** and <PGM3> icon to turn “PGM-3”.

Step 2. Select “3.Key Feature” and press **YES**, then select “1.PLU” and press **YES**.

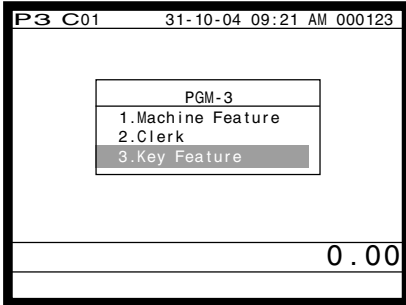

Step 1. screen

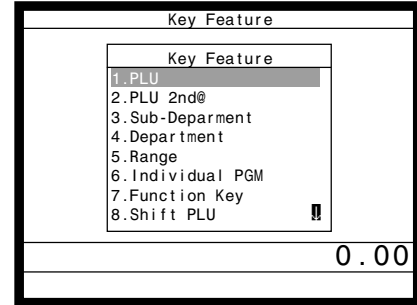

Step 2. screen

Step 3. Select the PLU record you want to program by pressing the flat-PLU key directly, by entering PLU record No. and **YES**, or by entering record No./random PLU code and **PLU**.

Step 4. Link department programming:

Select “Dept Link” line, press **YES**, select the appropriate link department and **YES**.

Tax status programming:

Select “Taxable status” line, and press **YES** select the appropriate tax status.

Listing capacity programming:

Select “High Amount Limit” line (press **PAGE DOWN** three times), and enter the amount and press **YES**.

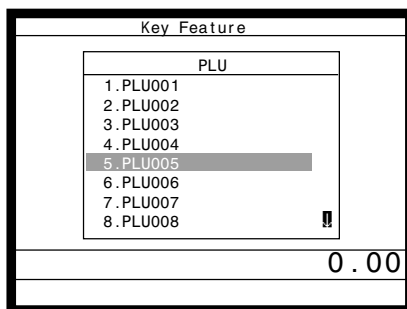

Step 3. screen

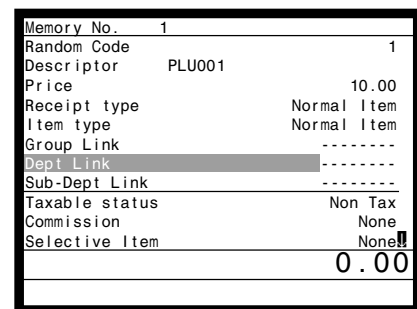

Step 4-1. screen

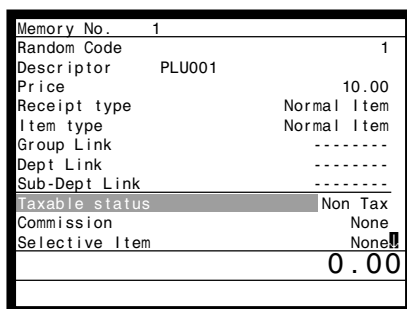

Step 4-2. screen

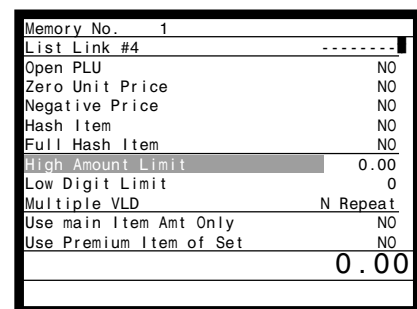

Step 4-3. screen

Step 5. Press **ESC/SKIP** and repeat the step 3. and 4., if you program to the other record.

Step 6. Press **ESC/SKIP** repeatedly to return to the “Step 1. screen”.

Registering flat-PLU keys by programming data

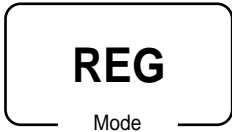

Preset price

OPERATION PRINTOUT (by optional remote printer)

Item	Unit price	(\$1.00) _{preset}
	Quantity	1
	Flat-PLU	2
Payment	Cash	\$1.00

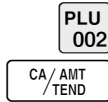

		MC #01	
REG	C01	31-10-2004 09:30 AM 000007	
1	PLU002		.1.00
	TL		- 1.00
	CASH		.1.00

Preset tax status

OPERATION PRINTOUT (by optional remote printer)

Item 1	Unit price	(\$2.00) _{preset}
	Quantity	5
	Flat-PLU	3
	Taxable	(1) _{preset}
Item 2	Unit price	(\$2.00) _{preset}
	Quantity	1
	Flat-PLU	4
	Taxable	(2) _{preset}
Payment	Cash	\$20.00

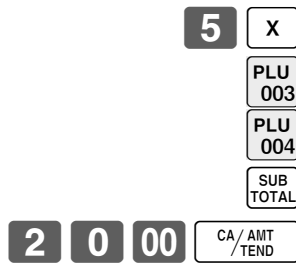

		MC #01	
REG	C01	31-10-2004 09:35 AM 000008	
5	PLU003		.10.00 T1
1	PLU004		.2.00 T2
	TA1		.10.00 Tax status
	TX1		.0.40 Taxable Amount 1
	TA2		.2.00 Tax 1
	TX2		.0.20 Taxable Amount 2
	TL		- 12.60 Tax 2
	CASH		.20.00
	CG		.7.40

* Before this registration, tax table programming is necessary.

Locking out high amount limitation

OPERATION PRINTOUT (by optional remote printer)

Item	Unit price	\$1.05
	Quantity	1
	Flat-PLU	3
	Max.amount	(\$10.00) _{preset}
Payment	Cash	\$2.00

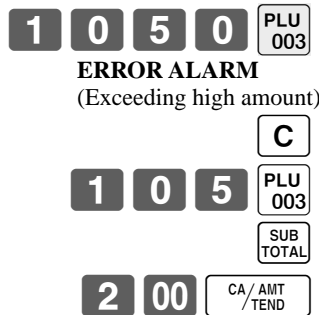

		MC #01	
REG	C01	31-10-2004 09:40 AM 000009	
1	PLU003		.1.05
	TL		- 1.05
	CASH		.2.00
	CG		.0.95

Preparing and using discounts/reductions

This section describes how to prepare and register discounts/reductions.

Programming discount rate and reduction amount

Step 1. Press **MODE** and <PGM1> icon to turn “PGM-1” and press **YES**.

Step 2. Press **PAGE DOWN** twice and select “10.Pulldown Group” and press **YES**.

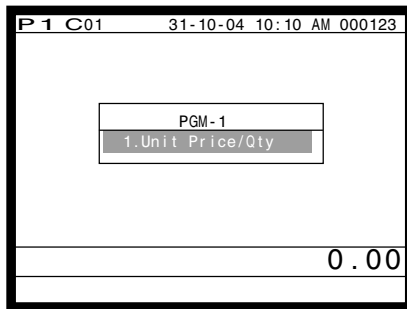

Step 1. screen

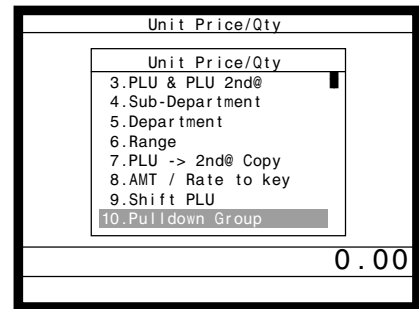

Step 2. screen

Step 3. Press **PAGE DOWN** five times and press **YES**.

Step 4. Discount rate: Select the %- record, enter discount rate (ex. 12.34% → 123400) and press **YES**.

Reduction amount: Select the - record, enter reduction amount and press **YES**.

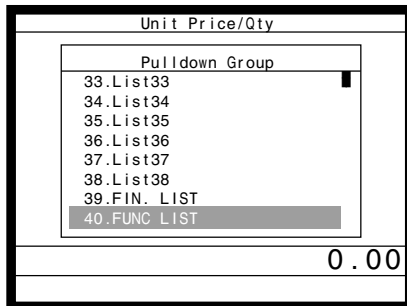

Step 3. screen

No.	Descriptor	Price
	SEAT#	00000000
	CANCEL	00000000
	ADD CHK	00000000
	-	00001000
	VAT	00000000
	%-	00123400
	MEDIA CHG	00000000
	RC	00000000
	RCT ON/OFF	00000000
	PD	00000000
	-----	00000000!!
-		@10.00

Step 4. screen

Step 5. Press **ESC/SKIP** repeatedly to return to the “Step 1. screen”.

NOTE:

In case of programming a rate or an amount to the actual key (not in a list window), select “8.AMT/Rate to key” in the Step 2, enter the appropriate rate or amount and press the key.

Registering discounts



The following example shows how you can use the **%-** key in various types of registration.

Discount for items and subtotals

Item 1	Unit price	\$5.00
	Flat-PLU	1
	Taxable	(1) _{preset}
Item 2	Unit price	(\$10.00) _{preset}
	Flat-PLU	2
	Taxable	(2) _{preset}
Discount	Rate	(5%) _{preset}
Subtotal discount	Rate	3.5%
	Taxable	Nontaxable
Payment	Cash	\$15.00

OPERATION

5 00 **PLU 001**

PLU 002

FUNC LIST **%-**

Applies the preset discount rate to the last item registered.

FUNC LIST **3 . 5** **%-**

The input value takes priority of the preset value.

SUB TOTAL

1 5 00 **CA/AMT TEND**

MC #01

REG C01 31-10-2004 10:15 AM 000016

1 PLU001	-5.00	T1
1 PLU002	-10.00	T2
5%		
%-	-0.50	T2
ST	-14.50	
3.5%		
%-	-0.51	
TA1	-5.00	
TX1	-0.20	
TA2	-9.50	
TX2	-0.48	
TL	- 14.67	
CASH	-15.00	
CG	-0.33	

- You can manually input rates up to 4 digits long (0.01% to 99.99%).

Taxable status of the **%-** key

- Whenever you perform a discount operation on the last item registered, the tax calculation for discount amount is performed in accordance with the tax status programmed for that item.
- Whenever you perform a discount operation on a subtotal amount, the tax calculation for the subtotal amount is performed in accordance with the tax status programmed for the **%-** key.

Basic Operations and Setups

Registering reductions





The following examples show how you can use the  key in various types of registration.

Reduction for items

Item 1	Unit price	\$5.00
	Flat-PLU	1
	Taxable	(1) _{preset}
Reduction	Amount	\$0.25
Item 2	Unit price	(\$6.00) _{preset}
	Flat-PLU	2
	Taxable	(1) _{preset}
Reduction	Amount	(\$0.50) _{preset}
Payment	Cash	\$11.00

OPERATION







 Reduces the last amount registered by the value input.









PRINTOUT (by optional remote printer)

```

MC #01
REG C01 31-10-2004 10:20 AM 000017
1 PLU001          .5.00 T1
-                -0.25 T1
1 PLU002          .6.00 T1
-                -0.50 T1
TA1              .10.25
TX1              .0.41
TL               -10.66
CASH             .11.00
CG               .0.34
  
```

- You can manually input reduction values up to 7 digits long.
- If you want to subtract the reduction amount from the department or PLU totalizer, program “Net totaling.”

Reduction for subtotal

Item 1	Unit price	\$3.00
	Flat-PLU	1
	Taxable	(1) _{preset}
Item 2	Unit price	\$4.00
	Flat-PLU	2
	Taxable	(2) _{preset}
Subtotal Reduction	Amount	\$0.75
	Taxable	(No) _{preset}
Payment	Cash	\$7.00

OPERATION











 Reduces the subtotal by the value input here.





PRINTOUT (by optional remote printer)

```

MC #01
REG C01 31-10-2004 10:25 AM 000018
1 PLU001          .3.00 T1
1 PLU002          .4.00 T2
-                -0.75
TA1              .3.00
TX1              .0.12
TA2              .4.00
TX2              .0.20
TL               -6.57
CASH             .7.00
CG               .0.43
  
```

Registering credit and check payments

The following examples show how to register credits and payments by check.



Check

OPERATION

Item	Unit price	\$11.00
	Flat-PLU	1
Payment	Check	\$20.00

1 1 00 PLU 001
SUB TOTAL
FIN. LIST 2 0 00 CHK/TEND

PRINTOUT (by optional remote printer)

		MC #01	
REG	C01	31-10-2004	10:30 AM 000019
1	PLU001		.11.00
	TL		- 11.00
	CHECK		.20.00
	CG		.9.00

Credit

OPERATION

Item	Unit price	\$15.00
	Flat-PLU	1
Reference	Number	1234
Payment	Credit	\$15.00

1 5 00 PLU 001
SUB TOTAL
1 2 3 4 #/NS
FIN. LIST CR

PRINTOUT (by optional remote printer)

		MC #01	
REG	C01	31-10-2004	10:35 AM 000020
1	PLU001		.15.00
	#/NS		1234
	TL		- 15.00
	CREDIT		.15.00

Reference No.

Mixed tender (cash, credit and check)

OPERATION

Item	Unit price	\$55.00
	Flat-PLU	1
Payment	Check	\$30.00
	Cash	\$5.00
	Credit	\$20.00

5 5 00 PLU 001
SUB TOTAL
FIN. LIST 3 0 00 CHK/TEND
5 00 CA/AMT TEND
FIN. LIST CR

PRINTOUT (by optional remote printer)

		MC #01	
REG	C01	31-10-2004	10:40 AM 000021
1	PLU001		.55.00
	TL		- 55.00
	CHECK		.30.00
	CASH		.5.00
	CREDIT		.20.00

Registering both the Euro and local currency

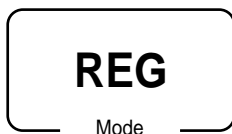

The following example shows the basic operation using the currency exchange function between the Euro and the local currency.

Case A

Main currency	Local
Payment	Euro
Change	Local
Rate	1 Euro = 0.5 FFr

OPERATION

6 0 0

← Press the key, which converts the subtotal amount into the sub currency by applying the preset exchange rate. And the subtotal in the sub currency is shown on the display.

1 5 00

← Press the key to finalize the transaction. The change amount is shown in the programmed currency.

DISPLAY

REG C01	31-10-04 10:45 AM 000023
PLU001	-6.00
TL	EUR 12.00
CASH	EUR15.00
	-7.50
CG	-1.50
EUR3.00	
CG	EUR3.00

PRINTOUT (by optional remote printer)

REG C01	MC #01	31-10-2004 10:45 AM 000022
1 PLU001	-6.00	
TL	EUR 12.00	
CASH	EUR15.00	
	-7.50	
CG	-1.50	
EUR3.00		

Case B

Main currency	Euro
Payment	Local
Change	Euro
Rate	1 Euro = 0.5 FFr

OPERATION

1 **2** **00** **PLU**
001

FUNC
LIST **PD**

⇐ Press the **PD** key, which converts the subtotal amount into the sub currency by applying the preset exchange rate. And the subtotal in the sub currency is shown on the display.

6 **00** **CA/AMT**
TEND

⇐ Press the **CA/AMT TEND** key to finalize the transaction. The change amount is shown in the programmed currency.

DISPLAY

REG C01	31-10-04	10:45 AM	000024
PLU001		EUR12.00	
TL		EUR 12.00	
		- 6.00	
CASH		·6.00	
CG	EUR12.00		EURO.00
	·0.00		
CG			·0.00

PRINTOUT (by optional remote printer)

			MC #01
REG C01	31-10-2004	10:50 AM	000024
1 PLU001		EUR12.00	
TL		EUR 12.00	
		- 6.00	
CASH		·6.00	
CG	EUR12.00		EURO.00
	·0.00		

Registering returned goods in the REG mode

The following example shows how to use the **RF** key in the REG mode to register goods returned by customers.



OPERATION

Item 1	Unit price	\$2.35
	Flat-PLU	1
Item 2	Unit price	\$2.00
	Flat-PLU	2
Item 3	Unit price	(\$1.20) _{preset}
	Flat-PLU	3
Returned Item 1	Unit price	\$2.35
	Flat-PLU	1
Returned Item 3	Unit price	(\$1.20) _{preset}
	Flat-PLU	3
Payment	Cash	\$2.00

2 3 5 **PLU 001**
2 00 **PLU 002**
PLU 003
RF
2 3 5 **PLU 001**
 Press **RF** before the item you want to return.
RF
PLU 003
SUB TOTAL
CA / AMT / TEND

PRINTOUT (by optional remote printer)

		MC #01
REG	C01	31-10-2004 11:00 AM 000025
1	PLU001	-2.35
1	PLU002	-2.00
1	PLU003	-1.20
	RF
1	PLU001	-2.35
	RF
1	PLU003	-1.20
	TL	- 2.00
	CASH	2.00

NOTE

- First of all, it is necessary to allocate **RF** key on the keyboard or in the function key list.

Registering returned goods in the REF mode

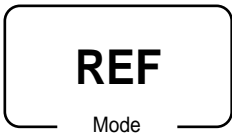

The following examples show how to use the REF mode to register goods returned by customers.

First of all, press the **MODE** key and press <REF MODE> icon to turn the REF mode.

Normal refund transaction

	OPERATION	PRINTOUT (by optional remote printer)															
<table border="1" style="width: 100%; border-collapse: collapse;"> <tr> <td style="width: 20%;">Returned Item 1</td> <td style="width: 20%;">Unit price</td> <td style="width: 60%;">\$1.50</td> </tr> <tr> <td></td> <td>Quantity</td> <td>2</td> </tr> <tr> <td>Returned Item 2</td> <td>Unit price</td> <td>(\$1.20)_{preset}</td> </tr> <tr> <td></td> <td>Quantity</td> <td>6</td> </tr> <tr> <td>Payment</td> <td>Cash</td> <td>\$10.20</td> </tr> </table>	Returned Item 1	Unit price	\$1.50		Quantity	2	Returned Item 2	Unit price	(\$1.20) _{preset}		Quantity	6	Payment	Cash	\$10.20	<p>1 5 0 PLU 001</p> <p>6 X</p> <p>PLU 001</p> <p>PLU 003</p> <p>CA/AMT /TEND</p>	<div style="border: 1px solid black; padding: 5px;"> <p style="text-align: right;">MC #01</p> <p>RF C01 31-10-2004 11:00 AM 000026 REF mode symbol</p> <p>1 PLU001 .1.50</p> <p>1 PLU001 .1.50</p> <p>6 PLU003 .7.20</p> <p>TL - 10.20</p> <p>CASH .10.20</p> </div>
Returned Item 1	Unit price	\$1.50															
	Quantity	2															
Returned Item 2	Unit price	(\$1.20) _{preset}															
	Quantity	6															
Payment	Cash	\$10.20															

Reduction of amounts paid on refund

	OPERATION	PRINTOUT (by optional remote printer)																					
<table border="1" style="width: 100%; border-collapse: collapse;"> <tr> <td style="width: 20%;">Returned Item 1</td> <td style="width: 20%;">Unit price</td> <td style="width: 60%;">\$4.00</td> </tr> <tr> <td></td> <td>Quantity</td> <td>1</td> </tr> <tr> <td>Reduction</td> <td>Amount</td> <td>\$0.15</td> </tr> <tr> <td>Returned Item 2</td> <td>Unit price</td> <td>(\$1.20)_{preset}</td> </tr> <tr> <td></td> <td>Quantity</td> <td>1</td> </tr> <tr> <td>Discount</td> <td>Rate</td> <td>(5%)_{preset}</td> </tr> <tr> <td>Payment</td> <td>Cash</td> <td>\$5.20</td> </tr> </table>	Returned Item 1	Unit price	\$4.00		Quantity	1	Reduction	Amount	\$0.15	Returned Item 2	Unit price	(\$1.20) _{preset}		Quantity	1	Discount	Rate	(5%) _{preset}	Payment	Cash	\$5.20	<p>4 00 PLU 003</p> <p>1 5 -</p> <p>PLU 002</p> <p>%-</p> <p>SUB TOTAL</p> <p>CA/AMT /TEND</p>	<div style="border: 1px solid black; padding: 5px;"> <p style="text-align: right;">MC #01</p> <p>RF C01 31-10-2004 11:10 AM 000027</p> <p>1 PLU003 -4.00 T1</p> <p>- -0.15 T1</p> <p>1 PLU002 -1.20 T2</p> <p>5%</p> <p>%- -0.06 T2</p> <p>TA1 -3.85</p> <p>TX1 -0.15</p> <p>TA2 -1.14</p> <p>TX2 -0.06</p> <p>TL - 5.20</p> <p>CASH -5.20</p> </div>
Returned Item 1	Unit price	\$4.00																					
	Quantity	1																					
Reduction	Amount	\$0.15																					
Returned Item 2	Unit price	(\$1.20) _{preset}																					
	Quantity	1																					
Discount	Rate	(5%) _{preset}																					
Payment	Cash	\$5.20																					

Important!

- To avoid miss registrations in the REF mode, return the mode to the former position immediately.

Registering money received on account

REG
Mode

The following example shows how to register money received on account. This registration must be performed out of a sale.

OPERATION

Received amount	\$700.00
-----------------	----------

FUNC LIST **7 00 00** RC

Amount can be up to 8 digits.

PRINTOUT

(by optional remote printer)

		MC #01	
REG	C01	31-10-2004 11:15 AM	000028
	RC		.700.00

Registering money paid out

REG
Mode

The following example shows how to register money paid out from the terminal. This registration must be performed out of a sale.

OPERATION

Paid out amount	\$1.50
-----------------	--------

FUNC LIST **1 5 0** PD

Amount can be up to 8 digits.

PRINTOUT

(by optional remote printer)

		MC #01	
REG	C01	31-10-2004 11:20 AM	000029
	PD		.1.50

Making corrections in a registration

REG

Mode

There are four techniques you can use to make corrections in a registration.

- To correct an item that you input but not yet registered.
- To correct the last item you input and registered.
- To correct the item you registered previously in the transaction.
- To cancel all items in a transaction.

To correct an item you input but not yet registered

OPERATION

PRINTOUT (by optional remote printer)

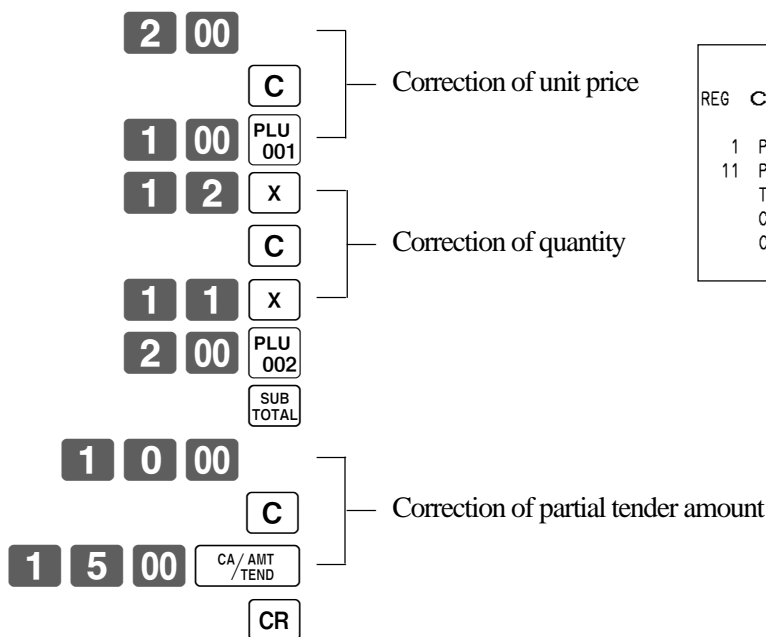

		MC #01	
REG	C01	31-10-2004	11:40 AM 000033
1	PLU001		· 1.00
11	PLU002		· 22.00
	TL		- 23.00
	CASH		· 15.00
	CREDIT		· 8.00

Basic Operations and Setups

To correct an item you input and registered

OPERATION

PRINTOUT (by optional remote printer)

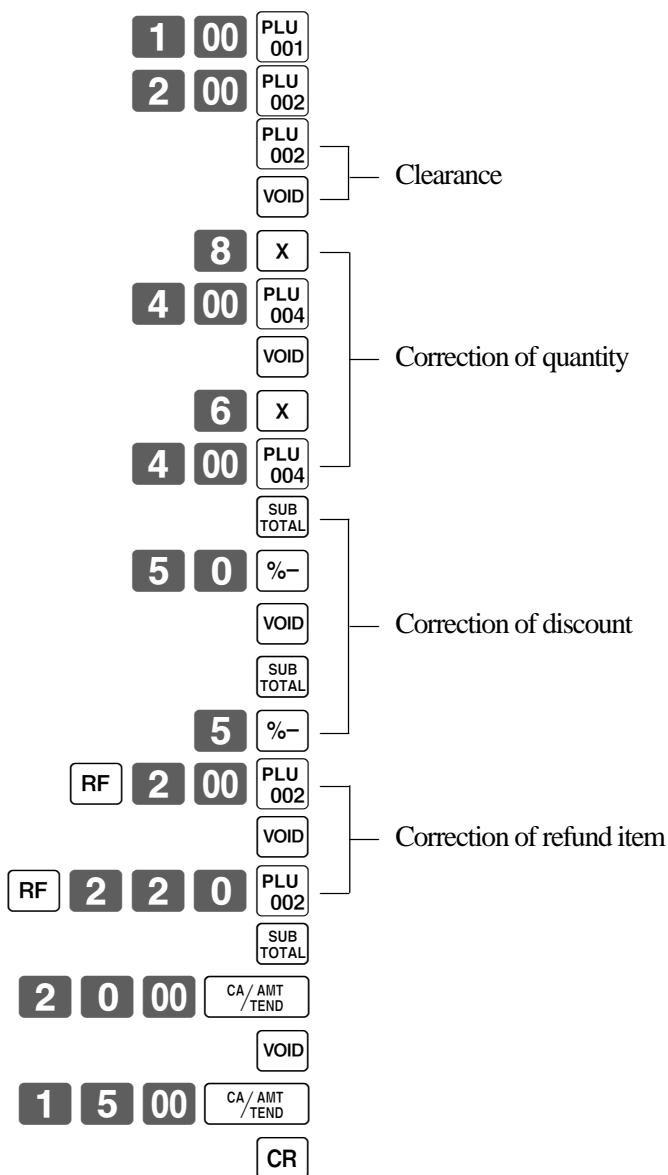

		MC #01	
REG	C01	31-10-2004 11:45 AM 000034	
1	PLU001		.1.00
1	PLU002		.2.00
1	PLU002		.2.00
	VOID		.2.00
8	PLU003		.32.00
	VOID		.32.00
6	PLU003		.24.00
	ST		.27.00
	50%		
	%-		.19.25
	VOID		.19.25
	ST		.27.00
	5%		
	%-		.1.35
	RF	
-1	PLU002		.2.00
	VOID		.2.00
	RF	
-1	PLU002		.2.20
	TL		.23.45
	CASH		.20.00
	VOID		.20.00
	CASH		.15.00
	CREDIT		.8.45

* These items are printed on journal only.

To correct the item you registered previously in this receipt

OPERATION **PRINTOUT**
(by optional remote printer)

Step three lines up to designate the item.

		MC #01	
REG	C01	31-10-2004	11:50 AM 000035
1	PLU002		-2.00
1	PLU003		-3.00
6	PLU001		-6.00
	TL		- 11.00
	CASH		-11.00

To cancel all items in a transaction

OPERATION **PRINTOUT**
(by optional remote printer)

		MC #01	
REG	C01	31-10-2004	11:55 AM 000036
1	PLU001		-1.00
1	PLU002		-2.00
1	PLU003		-3.00
1	PLU004		-4.00
	CANCEL	

Pressing key is necessary to cancel the transaction.

No sale registration

REG
 Mode

You can use the following procedure to open the drawer without registering a sale. This operation must be performed out of a sale.

OPERATION **PRINTOUT**
(by optional remote printer)

No receipt is issued.

Printing the daily sales reset report

This report shows daily sales totals.

Procedure

Step 1. Press **MODE** and **<X/Z>** icon to turn “X/Z Report”.

Step 2. Select “4.Daily Z” and press **YES**.

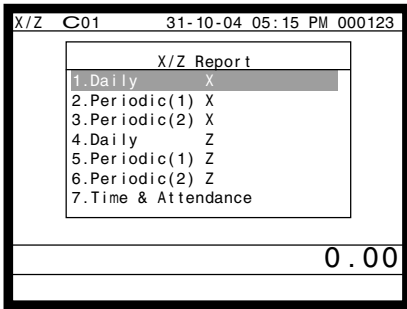

Step 1. screen

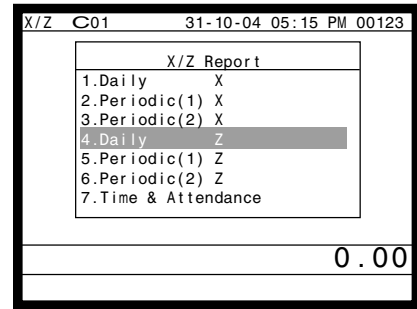

Step 2. screen

Step 3. Select “1.Batch” and press **YES**.

Step 4. Select “1.Batch(1)” and press **YES**.

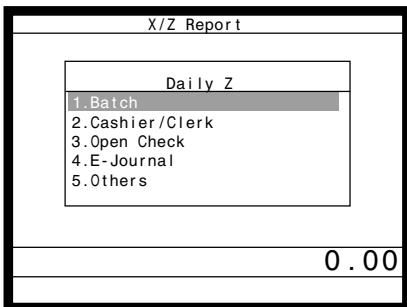

Step 3. screen

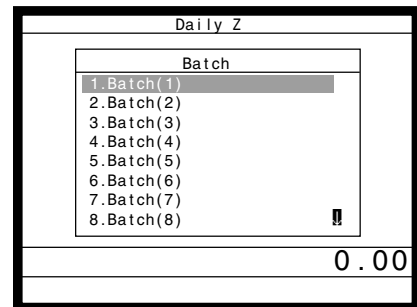

Step 4. screen

Step 5. Press **ESC/SKIP** repeatedly to return to the “Step 1. screen”.

Printout (by optional remote printer)

			MC #01	Machine No.
Z	C01	31-10-2004	05:15 PM 000237	Clerk/Date/Time/Consecutive No.
Z	0001011	FIXED TTL		Report code/title/reset counter
GROSS		981.250	·6,574.40	Gross total *2
NET	No	111	·7,057.14	Net total *2
CAID			·1,919.04	Cash in drawer *2
CKID			·859.85	Check in drawer *2
CRID			·709.85	Credit in drawer *2
RF	No	3	·10.22	Refund mode *2
DC			·1.22	Discount total *2
REF			·2.42	Refund key *2
CLEAR	No	85		Clear key count *2
TA1			·2,369.69	Taxable 1 amount *2
TX1			·128.86	Tax 1 amount *2
EX1	No	0	·0.00	Taxable 2 amount *2
TA2			·2,172.96	Tax 2 amount *2
TX2			·217.33	
EX2	No	0	·0.00	
TA10			·0.00	
TX10			·0.00	
EX10	No	0	·0.00	
GT1			·125478.96	Grand total 1 *2
GT2			·346284.23	Grand total 2 *2
GT3			·123212.75	Grand total 3 *2
Z	0001012	FREE FUNCTION		Report code/title/reset counter
CASH	No	362	·1,638.04	Function key count/amount *1
CHECK	No	56	·1,174.85	
RC	No	4	·810.00	
PD	No	5	·520.00	
-	No	3	·410.00	
%-	No	5	·5.00	
VOID	No	14	·39.55	
RCT	No	3		
NS	No	5		
CANCEL	No	1	·100.28	
Z	0001015	DEPT		Report code/title/reset counter
DEPT01		203.25	·1,108.54	Department count/amount *1
DISCOUNT			·10.00	Discount total
DEPT02		183	·1,362.26	
DISCOUNT			·0.00	
DEPT03		5	·17.22	
DISCOUNT			·0.00	
TL		421.25	·2,872.28	Department total
DISCOUNT			·112.08	
Z	0001017	CASHIER/CLERK		Report code/title/reset counter
C01			·1	Clerk name/drawer No. *1
GROSS		421.254	·2,872.28	Gross total *1
NET	No	111	·1,845.35	Net total *1
CAID			·1,057.14	Cash in drawer *1
CRID			·0.19	Credit in drawer *1
CKID			·9.02	Check in drawer *1
C02			·1	Clerk name/drawer No.

*1 Zero totalled departments/functions/clerks are not printed by programming.

*2 These items can be skipped by programming.

Advanced Operations

This chapter describes more sophisticated operations that you can use to suit the needs of your retail environment.

Post-finalization receipt

The post-finalization receipt lets you issue a receipt after finalization of the transaction.

Note that all of the following conditions must be satisfied.

- The receipt issuance status must be OFF.
- The transaction must be finalized in the REG, REF or REG- mode using <CASH>, <CHARGE>, <CREDIT> or <CHECK>.

Receipt example

OPERATION

Item 1	Flat 1	\$10.00
	Quantity	1
Item 2	Flat 2	\$20.00
	Quantity	1
Payment	Cash	\$30.00

1 0 00
2 0 00

3 0 00

Receipt is not issued.
Sign on a clerk. (if necessary)

Post-finalization receipt is issued.

PRINTOUT (by optional remote printer)

		MC #01
REG	C01	31-10-2004 01:00 PM 001050
1	PLU001	.10.00
1	PLU002	.20.00
	TL	-30.00
	CASH	.30.00
	CG	.00.00

Important!

- After initialization, the terminal can issue only one post-finalization receipt per transaction.

NOTE

- This key is used for "GUEST RECEIPT" key in check tracking operation.

Inputting the number of customers

Example 1

Customer	Number	2
Item 1	Flat 1	\$15.00
	Quantity	1
Item 2	Flat 2	\$5.00
	Quantity	1
Payment	Cash	\$20.00

OPERATION

2 COVERS

1 5 00 PLU 001

5 00 PLU 002

SUB TOTAL

2 0 00 CA/AMT TEND

PRINTOUT
(by optional remote printer)

```

MC #01
REG C01 31-10-2004 01:10 PM 001051
2CT
1 PLU001 .15.00
1 PLU002 .5.00
TL -20.00
CASH .20.00
CG .0.00

```

Example 2

You can only use the following operation to re-input the number of customers when **COVERS** (customer number key) is preset to allow re-input. When programming prohibits re-input of the number of customers, this operation causes an error.

OPERATION

3 COVERS

1 5 00 PLU 001

5 00 PLU 002

2 COVERS

SUB TOTAL

2 0 00 CA/AMT TEND

PRINTOUT
(by optional remote printer)

```

MC #01
REG C01 31-10-2004 01:15 PM 001052
2CT
1 PLU001 .15.00
1 PLU002 .5.00
TL -20.00
CASH .20.00
CG .0.00

```

You can re-input the number of customers either immediately after the initial input or during later registration.

Example 3

You can use the following operation to add customers to an original number of customers input (when addition to the number of the customer is allowed).

OPERATION

3 COVERS

1 5 00 PLU 001

5 00 PLU 002

2 COVERS

SUB TOTAL

2 0 00 CA/AMT TEND

PRINTOUT
(by optional remote printer)

```

MC #01
REG C01 31-10-2004 01:20 PM 001055
5CT
1 PLU001 .15.00
1 PLU002 .5.00
TL -20.00
CASH .20.00
CG .0.00

```

NOTE

- After initialization, the terminal does not print the number of customer on receipts.

Clerk interrupt function

There are two types of clerk interrupt function, illustrated by Procedure 1 and Procedure 2 below.

- In Procedure 1, each clerk possesses a unique clerk interrupt buffer, and so the clerk interrupt function gives each individual clerk the ability to perform an independent registration operation. In this case, each clerk is individually linked to a unique clerk interrupt buffer.
- In Procedure 2, multiple clerks use the same clerk interrupt buffer, and so a single clerk interrupt operation (clerk change during registration) can perform any registration that is in progress. In this case, multiple clerks are linked to a single clerk interrupt buffer.

In this procedure, “Allow clerk to open check No. belonging to another clerk” program is necessary.

Note the following important points concerning the clerk interrupt function.

- The terminal must be programmed to allow use of the clerk interrupt function.
- In the REG, REF, and REG– modes, clerks can be change while a transaction is in progress, making it possible for multiple clerks to simultaneously perform registrations using a single terminal.

For example, if clerk 1 is interrupted while registering a transaction, clerk 2 can use the same machine to register a different transaction. Then clerk 1 can continue the original registration from the point where it was interrupted.

Procedure 1

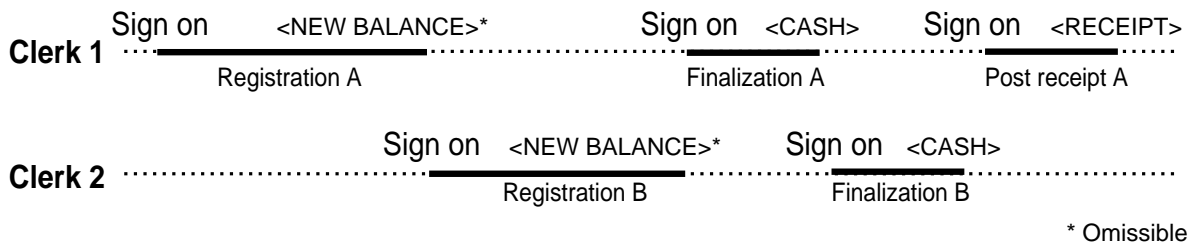

Procedure 2

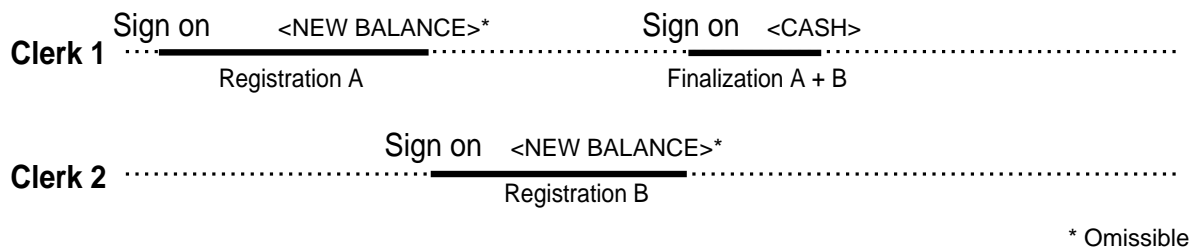

NOTES

- A cancel operation can be performed during registration by either of the clerks. When clerk 1 signs back on (after being interrupt by clerk 2), the cancel operation cancels only the items registered after signing back on (only this receipt) or from the top of the transaction. This is selectable by the key program.
- A <NB> key must be programmed in order to use clerk interrupt.

Printing slip

To perform batch printing on the slip printer, you must first connect the slip printer (SP-1300: option) and use the memory allocation operation (see program 5 mode in the programming manual) to reserve registration buffer memory. The capacity of the registration buffer memory is determined by the number of records of registration buffer memory reserved by the memory allocation operation.

There are two ways to print slips:

1. Print all items that are registered until the last slip printing.
2. Print only additional items that are registered until the last receipt issuance (ex. charge posting system).
If you select “option 2”, program “Auto Line Find” also.

Printing slips

The terminal can be connected to the optional SP-1300 slip printer, which features an automatic feed function and automatic back feed function.

• Automatic feed function

This function makes it possible to program the number of line feeds that should be inserted from the normal print start position before starting slip printing. Even if line feeds are programmed for this function, they are not inserted for validation printing, check endorsement printing, and check printing performed using the slip printer.

• Automatic back feed function

This function performs automatic back feed following slip printing, validation printing, and endorsement printing on the slip printer. The slip paper is released once the back feed operation is complete.

• Manual feed function

<SLIP FEED/RELEASE> (slip feed/release key: assigned to the terminal’s keyboard using the program 4 mode) can be used for manual feed of the slip paper. You perform manual feed by inputting a value for the number of lines (up to two digits in the range of 1 to 99) and then press <SLIP FEED/RELEASE>.

• Manual back feed function

<SLIP BACK FEED/RELEASE> (slip back feed/release key: assigned to the terminal’s keyboard using the program 4 mode) can be used for manual back feed of the slip paper. Manual back feed can be performed by inputting a value for the number of lines (up to two digits in the range of 1 to 99) and then press <SLIP BACK FEED/RELEASE>.

You can print slips using automatic or manual batch printing. The slip print operation can be performed in REG, REF, and REG– modes only.

Finalizing a registration without inserting a slip paper into the slip printer when the terminal is programmed as “Slip Automatic Batch Print Compulsory” produces an error.

To perform auto batch printing 1

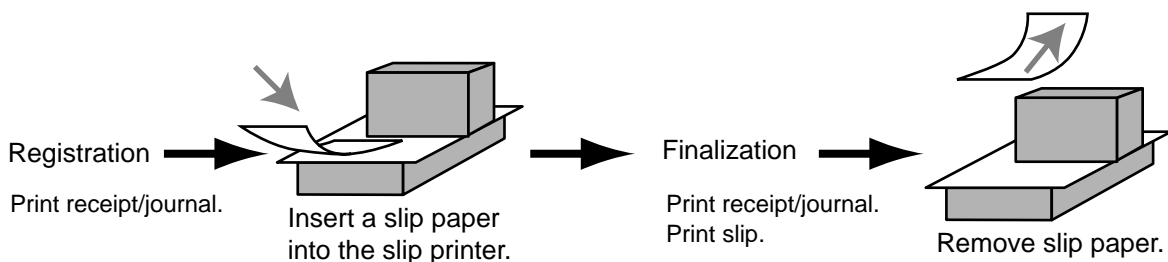

To perform auto batch printing 2

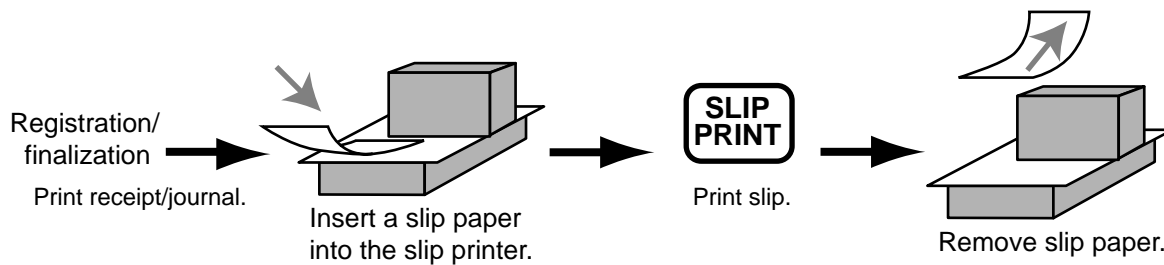

About the maximum number of slip lines

You can program the maximum number of lines that can be printed on a slip. Once you do, any attempt to exceed the preset maximum results in an error. When such an error occurs, change slip paper and press <SLIP PRINT> to restart printing.

Check tracking systems

Check tracking system

With the check tracking system, the amount, check number, number of slip print lines, machine number, date/time and registration detail data are stored in two files (check tracking index file and check tracking detail file).

- Check tracking detail file and index file are cleared by the following timing:
 1. Check number method: The same check number is not used during daily operation.
The check is cleared after printing finalized data on slip or guest check receipt, or the check is also cleared when the new or old check operation is made on the terminal finalized the transaction.
 2. Table number method: The same check number is used during daily operation.
The check is cleared after printing finalized data on slip or guest check receipt, or check is also cleared when the same finalized check number is assigned in new check operation.You can select one of these options by programming.
- Auto new balance function
The terminal can be programmed so that whenever a clerk (by i-Button key) signs off while a check is open, a <NEW BALANCE> operation is automatically performed to temporarily finalize the open check.
- You can specify a range of checks that can be opened by each clerk. Once you do, any attempt by a clerk to open a check using a number that is not within his specified range results in an error.
- Either of the following two operations can be used to correct input of a wrong check number.
<NEW CHECK>, <NEW/OLD>
Re-input the correct check number, or cancel the original check number, issue a receipt, and then re-input the correct check number.
<OLD CHECK>, <NEW/OLD>
Temporary finalize the original check number, issue a receipt, and then re-input the correct check number.
Printing examples are described under “Print Additional item only” programming.

Opening a check

Example

Check#		1234
Table#		33
Item 1	Flat 1	\$10.00
	Quantity	2
Item 2	Flat 2	\$20.00
	Quantity	2
Item 3	Flat 3	\$30.00
	Quantity	1

OPERATION

1 2 3 4 NEW CHECK
3 3 TABLE #
1 0 00 PLU 001
2 0 00 PLU 002
3 0 00 PLU 003
Insert slip
NB
Remove slip

PRINTOUT
(by optional remote printer)

REG C01	31-10-2004 01:30 PM 001056	MC #01	
CHECK No. 1234		#000033	Check No./Table No.
1 PLU001		-10.00	
1 PLU001		-10.00	
1 PLU002		-20.00	
1 PLU002		-20.00	
1 PLU003		-30.00	
+		-0.50	
SRVC TL		-90.50	New balance fee

Press <NEW BALANCE> to temporarily finalize the transaction. If you want to finalize a check immediately, use <CASH>, <CHARGE>, <CREDIT> or <CHECK>.

Adding to a check

Example

Check#		1234
Table#		33
Item 1	Flat 1	\$30.00
	Quantity	1
Item 2	Flat 2	\$10.00
	Quantity	1

OPERATION

1 2 3 4 OLD CHECK
3 0 00 PLU 001
1 0 00 PLU 002
Insert slip
NB
Remove slip

PRINTOUT
(by optional remote printer)

REG C01	31-10-2004 01:35 PM 001057	MC #01	
CHECK No. 1234		#000033	
ST		-90.50	
1 PLU001		-30.00	
1 PLU002		-10.00	
+		-0.50	
SRVC TL		-131.00	

- * Instead of designating the old check number directly, you can register the appropriate old check number (icon) in the check number pop-up window. (Refer to the page 18 of this manual.)
- The table number is stored in the check tracking index memory so its input is not required in this operation even if table number input is preset as compulsory. Table number input after inputting the check number may be performed, however, without generating an error.
- Once a check is opened under a number in REG mode, the same mode must be used to make additions to the check.

Advanced Operations

Issuing a guest receipt

The following operation can be used to print out the balance of a temporarily finalized check.

Example

OPERATION	PRINTOUT (by optional remote printer)																														
<div style="display: flex; justify-content: space-around; align-items: center;"> <div style="display: flex; gap: 5px;"> <div style="border: 1px solid black; padding: 2px 5px; width: 20px; height: 20px; text-align: center; font-weight: bold;">1</div> <div style="border: 1px solid black; padding: 2px 5px; width: 20px; height: 20px; text-align: center; font-weight: bold;">2</div> <div style="border: 1px solid black; padding: 2px 5px; width: 20px; height: 20px; text-align: center; font-weight: bold;">3</div> <div style="border: 1px solid black; padding: 2px 5px; width: 20px; height: 20px; text-align: center; font-weight: bold;">4</div> </div> <div style="border: 1px solid black; padding: 2px 5px; font-size: 8px; font-weight: bold;">RECEIPT</div> </div> <p style="text-align: center; margin-top: 5px;">Input the number of check you want.</p>	<div style="border: 1px solid black; padding: 5px;"> <div style="text-align: right; font-size: 10px;">MC #01</div> <div style="font-size: 10px;">REG C01 31-10-2004 01:30 PM 001056</div> <div style="font-size: 10px;">CHECK No 1234 #000033</div> <table style="width: 100%; border-collapse: collapse;"> <tr><td style="width: 5%;">1</td><td style="width: 85%;">PLU001</td><td style="width: 10%; text-align: right;">-10.00</td></tr> <tr><td>1</td><td>PLU001</td><td style="text-align: right;">-10.00</td></tr> <tr><td>1</td><td>PLU002</td><td style="text-align: right;">-20.00</td></tr> <tr><td>1</td><td>PLU002</td><td style="text-align: right;">-20.00</td></tr> <tr><td>1</td><td>PLU003</td><td style="text-align: right;">-30.00</td></tr> <tr><td></td><td>+</td><td style="text-align: right;">-0.50</td></tr> <tr><td>1</td><td>PLU001</td><td style="text-align: right;">-30.00</td></tr> <tr><td>1</td><td>PLU002</td><td style="text-align: right;">-10.00</td></tr> <tr><td></td><td>+</td><td style="text-align: right;">-0.50</td></tr> <tr><td></td><td>SRVC TL</td><td style="text-align: right; font-weight: bold;">- 131.00</td></tr> </table> <div style="font-size: 10px;"> <div style="display: flex; justify-content: space-between; border-bottom: 1px dashed black; padding-bottom: 2px;"> **** GUEST BOTTOM MESSAGE 1 **** </div> <div style="display: flex; justify-content: space-between; border-bottom: 1px dashed black; padding-bottom: 2px;"> **** GUEST BOTTOM MESSAGE 2 **** </div> <div style="display: flex; justify-content: space-between; border-bottom: 1px dashed black; padding-bottom: 2px;"> **** GUEST BOTTOM MESSAGE 3 **** </div> <div style="display: flex; justify-content: space-between; border-bottom: 1px dashed black; padding-bottom: 2px;"> **** : </div> <div style="display: flex; justify-content: space-between; padding-bottom: 2px;"> **** GUEST BOTTOM MESSAGE10 **** </div> </div> </div>	1	PLU001	-10.00	1	PLU001	-10.00	1	PLU002	-20.00	1	PLU002	-20.00	1	PLU003	-30.00		+	-0.50	1	PLU001	-30.00	1	PLU002	-10.00		+	-0.50		SRVC TL	- 131.00
1	PLU001	-10.00																													
1	PLU001	-10.00																													
1	PLU002	-20.00																													
1	PLU002	-20.00																													
1	PLU003	-30.00																													
	+	-0.50																													
1	PLU001	-30.00																													
1	PLU002	-10.00																													
	+	-0.50																													
	SRVC TL	- 131.00																													

Guest receipt message

Closing a check memory

Example

OPERATION	PRINTOUT (by optional remote printer)												
<div style="display: flex; justify-content: space-around; align-items: center;"> <div style="display: flex; gap: 5px;"> <div style="border: 1px solid black; padding: 2px 5px; width: 20px; height: 20px; text-align: center; font-weight: bold;">1</div> <div style="border: 1px solid black; padding: 2px 5px; width: 20px; height: 20px; text-align: center; font-weight: bold;">2</div> <div style="border: 1px solid black; padding: 2px 5px; width: 20px; height: 20px; text-align: center; font-weight: bold;">3</div> <div style="border: 1px solid black; padding: 2px 5px; width: 20px; height: 20px; text-align: center; font-weight: bold;">4</div> </div> <div style="border: 1px solid black; padding: 2px 5px; font-size: 8px; font-weight: bold;">OLD CHECK</div> </div> <p style="text-align: center; margin-top: 5px;">Insert slip</p> <div style="display: flex; justify-content: space-around; align-items: center; margin-top: 10px;"> <div style="display: flex; gap: 5px;"> <div style="border: 1px solid black; padding: 2px 5px; width: 20px; height: 20px; text-align: center; font-weight: bold;">1</div> <div style="border: 1px solid black; padding: 2px 5px; width: 20px; height: 20px; text-align: center; font-weight: bold;">5</div> <div style="border: 1px solid black; padding: 2px 5px; width: 20px; height: 20px; text-align: center; font-weight: bold;">0</div> <div style="border: 1px solid black; padding: 2px 5px; width: 20px; height: 20px; text-align: center; font-weight: bold;">00</div> </div> <div style="border: 1px solid black; padding: 2px 5px; font-size: 8px; font-weight: bold;">CA/AMT TEND</div> </div>	<div style="border: 1px solid black; padding: 5px;"> <div style="text-align: right; font-size: 10px;">MC #01</div> <div style="font-size: 10px;">REG C01 31-10-2004 01:40 PM 001058</div> <div style="font-size: 10px;">CHECK No. 1234 #000033</div> <table style="width: 100%; border-collapse: collapse;"> <tr><td style="width: 5%;">ST</td><td style="width: 85%;"></td><td style="width: 10%; text-align: right;">-131.00</td></tr> <tr><td>TL</td><td></td><td style="text-align: right; font-weight: bold;">- 131.00</td></tr> <tr><td>CASH</td><td></td><td style="text-align: right;">-150.00</td></tr> <tr><td>CG</td><td></td><td style="text-align: right;">-19.00</td></tr> </table> </div>	ST		-131.00	TL		- 131.00	CASH		-150.00	CG		-19.00
ST		-131.00											
TL		- 131.00											
CASH		-150.00											
CG		-19.00											

PRINTOUT
(by optional slip printer)

	MC #01
REG C01	31-10-2004 01:40 PM 001058
CHECK No. 1234	#000033
1 PLU001	-10.00
1 PLU001	-10.00
1 PLU002	-20.00
1 PLU002	-20.00
1 PLU003	-30.00
+	-0.50
#11 SRVC TL	-90.50
1 PLU001	-30.00
1 PLU002	-10.00
+	-0.50
#15 SRVC TL	-131.00
TL	-131.00
CASH	-150.00
CG	-19.00

New/old check key operation

When the <NEW/OLD> is pressed, check number pop-up window is opened. If the check number you want to use exists in the window, just press the icon and continue the registration.

Example: The check number exists in the window

Just press the icon instead of entering the check number, and continue the registration.

OPERATION **PRINTOUT**
(by optional remote printer)

Press the check 3456 icon.

1	0	00	PLU 001
2	0	00	PLU 002
			NB

	MC #01
REG C01	31-10-2004 01:50 PM 001060
CHECK No. 3456	
ST	-10.00
1 PLU001	-10.00
1 PLU002	-20.00
+	-0.50
SRVC TL	-40.50

Example: The check number does not exist in the window

If there is no appropriate check number in the window, enter the appropriate check number and press the <NEW/OLD> key. In this operation, the <NEW/OLD> key is treated as <NEW> key.

OPERATION **PRINTOUT**
(by optional remote printer)

3 3 3 3 NEW/OLD

Input a check number and press <NEW/OLD>.

1	0	00	PLU 001
2	0	00	PLU 002
			NB

	MC #01
REG C01	31-10-2004 01:56 PM 001061
CHECK No. 3333	
1 PLU001	-10.00
1 PLU002	-20.00
+	-0.50
SRVC TL	-30.50

Advanced Operations

Add check

This operation lets you combine the amounts of more than one check into a single check.

Example

Registration for check number 1234

Original check

Check#	1234	
Item 1	Flat 1	\$10.00
	Quantity	1
Item 2	Flat 2	\$20.00
	Quantity	1

OPERATION

1 2 3 4 NEW/OLD

3 3 TABLE #

1 0 00 PLU 001

2 0 00 PLU 002

NB

PRINTOUT (by optional remote printer)

REG	C01	31-10-2004 02:00 PM	001062	MC #01
CHECK No.	1234		#00033	
1	PLU001			.10.00
1	PLU002			.20.00
	+			.0.50
	SRVC TL			- 30.50

Registration for check number 3456

Added check

Check#	3456	
Item	Flat 1	\$30.00
	Quantity	1

OPERATION

3 4 5 6 NEW/OLD

3 0 00 PLU 001

NB

PRINTOUT (by optional remote printer)

REG	C01	31-10-2004 02:05 PM	001063	MC #01
CHECK No.	3456			
1	PLU001			.30.00
	+			.0.50
	SRVC TL			- 30.50

Registration for check number 1234

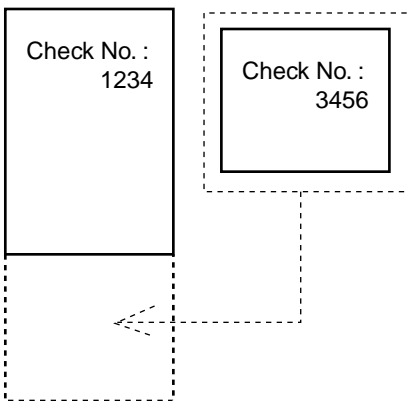

OPERATION

NEW/OLD

Press the check 1234 icon.

3 4 5 6 ADD CHECK

NB

PRINTOUT (by optional remote printer)

REG	C01	31-10-2004 02:10 PM	001064	MC #01
CHECK No.	1234		#0033	
	ST			.30.50
	ADD CHK			3456
	ST			.30.50
	+			.0.50
	SRVC TL			- 61.50

These lines are not printed on receipt.

Separate check

This operation makes it possible to split a single check into separate checks.

Example

Check# 1234		
Item 1	Flat 1	\$10.00
	Quantity	1
Item 2	Flat 2	\$20.00
	Quantity	1
Item 3	Flat 3	\$30.00
	Quantity	2
Item 4	Flat 4	\$40.00
	Quantity	1

Check# 3456		
Item 1	Flat 1	\$10.00
	Quantity	1
Item 2	Flat 3	\$30.00
	Quantity	1
Payment	Cash	\$40.00

OPERATION



Check pop-up window is opened.

Press the check 1234 icon.

Separate check window is opened.

Touch the item1 and item 3 of the original check.

Item 1 and 3 are moved from the original check to separated check.

Press <OK>.



DISPLAY

1	PLU001	*10.00
1	PLU002	*20.00
2	PLU003	*60.00
1	PLU004	*40.00
		*130.00

		*0.00
--	--	-------

1	PLU002	*20.00
1	PLU003	*30.00
1	PLU004	*40.00
		*90.00

1	PLU001	*10.00
1	PLU003	*30.00
		*40.00

PRINTOUT (by optional remote printer)

		MC #01
REG	C01	31-10-2004 02:15 PM 001065
		CHECK No. 3456
1	PLU001	.10.00
1	PLU003	.30.00
ST		.40.00
CASH		.40.00
CG		.0.00

Advanced Operations

Clerk transfer

This operation lets you change the clerk who is in charge of a specific open check number.

Example

To change the clerk for check number 1234 from clerk 1 to clerk 4.

OPERATION	PRINTOUT (by optional remote printer)												
<p style="text-align: right; margin-bottom: 0;"> CLK# </p> <p>Press this key if you do not want the clerk No. or clerk secret No. to appear on the display.</p> <p style="text-align: right; margin-bottom: 0;"> 1 CLK TRANS </p> <p>Input the clerk No. of the clerk who is currently in charge of check No. 1234 (target check).</p> <p style="text-align: right; margin-bottom: 0;"> 4 OPE # </p> <p>Input the clerk No. of the clerk who will take over check No. 1234 (target check).</p> <p style="text-align: center; margin-bottom: 0;"> 1 2 3 4 NEW CHECK </p> <p>Input the target check No. that is transferred from clerk 1 to 4. You can use either <OLD CHK>, <NEW/OLD>.</p> <p>Note that if you skip this step, all check Nos currently assigned to clerk 1 are transferred to clerk 4.</p> <p style="text-align: right; margin-top: 10px;"> CLK TRANS </p>	<div style="border: 1px solid black; padding: 5px; width: fit-content;"> <p style="text-align: right; margin: 0;">MC #01</p> <p>REG C01 31-10-2004 02:20 PM 001067</p> <p>CLK TRANS</p> <table style="width: 100%; border-collapse: collapse;"> <tr> <td style="width: 10%; border-bottom: 1px solid black;">C01</td> <td style="width: 40%; border-bottom: 1px solid black;">C04</td> <td style="width: 10%; border-bottom: 1px solid black;">·60.50</td> <td style="width: 40%;"></td> </tr> <tr> <td style="border-bottom: 1px solid black;">1234</td> <td style="border-bottom: 1px solid black;"></td> <td style="border-bottom: 1px solid black;"></td> <td style="border-bottom: 1px solid black;"></td> </tr> <tr> <td style="border-bottom: 1px solid black;">TL</td> <td style="border-bottom: 1px solid black;"></td> <td style="border-bottom: 1px solid black;">·60.50</td> <td style="border-bottom: 1px solid black;"></td> </tr> </table> </div> <p style="margin-left: 20px;">Check No./NB amount</p>	C01	C04	·60.50		1234				TL		·60.50	
C01	C04	·60.50											
1234													
TL		·60.50											

Table transfer

With this operation, you can change the number of a check.

Example 1

To change the check number 1234 to 1111 (which is newly opened).

OPERATION	PRINTOUT (by optional remote printer)																				
<div style="border: 1px solid black; padding: 5px; width: fit-content; margin-bottom: 10px;"> Check No: 1234 </div> <p>1111 <TBL TRN></p> <div style="display: flex; justify-content: space-around; align-items: center;"> <div style="border: 1px dashed black; padding: 5px; width: 40px; text-align: center;"> Check No: 1234 </div> <div style="border: 1px solid black; padding: 5px; width: 40px; text-align: center;"> Check No: 1111 </div> </div> <p style="text-align: center; margin-top: 10px;">Input the new check No.</p> <p style="text-align: right; margin-bottom: 0;"> 1 2 3 4 NEW CHECK 1 0 0 0 PLU 001 1 1 1 1 TABLE TRANS </p>	<div style="border: 1px solid black; padding: 5px; width: fit-content;"> <p style="text-align: right; margin: 0;">MC #01</p> <p>REG C01 31-10-2004 02:25 PM 001066</p> <p>CHECK No. 1234</p> <table style="width: 100%; border-collapse: collapse;"> <tr> <td style="width: 10%;">1</td> <td style="width: 40%;">PLU001</td> <td style="width: 10%;">·10.00</td> <td style="width: 40%;"></td> </tr> <tr> <td></td> <td>Check No.</td> <td></td> <td>1234</td> </tr> <tr> <td></td> <td>ST</td> <td>·10.00</td> <td></td> </tr> <tr> <td></td> <td>TBL TRANS</td> <td></td> <td>1111</td> </tr> <tr> <td></td> <td>SRVC TL</td> <td>- 10.00</td> <td></td> </tr> </table> </div>	1	PLU001	·10.00			Check No.		1234		ST	·10.00			TBL TRANS		1111		SRVC TL	- 10.00	
1	PLU001	·10.00																			
	Check No.		1234																		
	ST	·10.00																			
	TBL TRANS		1111																		
	SRVC TL	- 10.00																			

Example 2

To change the check number 3456 to 2222 (which has already been opened).

OPERATION	PRINTOUT (by optional remote printer)																								
<div style="display: flex; justify-content: space-around; align-items: center; margin-bottom: 10px;"> <div style="border: 1px solid black; padding: 5px; width: 40px; text-align: center;"> Check No: 3456 </div> <div style="border: 1px solid black; padding: 5px; width: 40px; text-align: center;"> Check No: 2222 </div> </div> <p>2222 <TBL TRN></p> <div style="display: flex; justify-content: space-around; align-items: center;"> <div style="border: 1px dashed black; padding: 5px; width: 40px; text-align: center;"> Check No: 3456 </div> <div style="border: 1px solid black; padding: 5px; width: 40px; text-align: center;"> Check No: 2222 </div> </div> <div style="border: 1px solid black; padding: 5px; width: 40px; text-align: center; margin-left: auto;"> Added </div> <p style="text-align: center; margin-top: 10px;"> 3 4 5 6 OLD CHECK 1 0 0 0 PLU 001 2 2 2 2 TABLE TRANS </p>	<div style="border: 1px solid black; padding: 5px; width: fit-content;"> <p style="text-align: right; margin: 0;">MC #01</p> <p>REG C01 31-10-2004 02:30 PM 001069</p> <p>CHECK No. 3456</p> <table style="width: 100%; border-collapse: collapse;"> <tr> <td style="width: 10%;"></td> <td style="width: 40%;">ST</td> <td style="width: 10%;">·10.00</td> <td style="width: 40%;"></td> </tr> <tr> <td>1</td> <td>PLU001</td> <td>·10.00</td> <td></td> </tr> <tr> <td></td> <td>Check No.</td> <td></td> <td>3456</td> </tr> <tr> <td></td> <td>ST</td> <td>·20.00</td> <td></td> </tr> <tr> <td></td> <td>TBL TRANS</td> <td></td> <td>2222</td> </tr> <tr> <td></td> <td>SRVC TL</td> <td>- 30.00</td> <td></td> </tr> </table> </div>		ST	·10.00		1	PLU001	·10.00			Check No.		3456		ST	·20.00			TBL TRANS		2222		SRVC TL	- 30.00	
	ST	·10.00																							
1	PLU001	·10.00																							
	Check No.		3456																						
	ST	·20.00																							
	TBL TRANS		2222																						
	SRVC TL	- 30.00																							

Condiment/preparation PLUs

You can force entering condiment or preparation PLU after the main PLU registration by programming.

Example (condiment PLU)

OPERATION			PRINTOUT (by optional remote printer)
	Flat 1	\$10.00	<div style="text-align: right; margin-bottom: 5px;">PLU 001</div> Registering main PLU. In case of condiment compulsory, no condiment registration occurs an error condition. <div style="margin-top: 10px;"> 1 2 PLU 1 3 PLU CA/AMT /TEND </div>
Condiment	Flat 3	\$0.10	
	PLU 12	\$0.20	
	PLU 13	\$0.30	
Payment	Cash	\$10.60	
			<pre> MC #01 REG C01 31-10-2004 02:50 PM 001080 1 PLU001 -10.00 1 PLU003 -0.10 1 PLU012 -0.20 1 PLU013 -0.30 TL -10.60 CASH -10.60 </pre>

Example (preparation PLU)

OPERATION			PRINTOUT (by optional remote printer)
	Flat 2	\$20.00	<div style="text-align: right; margin-bottom: 5px;">PLU 002</div> Registering main PLU. <div style="margin-top: 10px;"> 2 2 PLU 2 3 PLU CA/AMT /TEND </div>
Preparation	Flat 4	\$0.00	
	PLU 22	\$0.00	
	PLU 23	\$0.00	
Payment	Cash	\$20.00	
			<pre> MC #01 REG C01 31-10-2004 02:55 PM 001081 1 PLU002 -20.00 1 PLU004 1 PLU022 1 PLU023 TL -20.00 CASH -20.00 </pre>

Text recall

This procedure is used to recall text by inputting the address where the text is stored. The recalled text is printed on the receipt and journal. You can also choose recall texts by text recall sub window, which is shown by pressing <TEXT RECALL> directly.

Example

OPERATION			PRINTOUT (by optional remote printer)
	Flat 1	\$46.00	<div style="text-align: right; margin-bottom: 5px;">PLU 001</div> <div style="text-align: right; margin-bottom: 5px;">TEXT RECALL</div> <div style="text-align: right; margin-bottom: 5px;">PLU 002</div> <div style="text-align: right; margin-bottom: 5px;">TEXT RECALL</div> <div style="text-align: right; margin-bottom: 5px;">SUB TOTAL</div> <div style="text-align: right; margin-bottom: 5px;">CA/AMT /TEND</div>
Item 1	Quantity	1	
	Flat 2	\$10.00	
Item 2	Quantity	1	
	Payment	Cash	
Text 1	MEDIUM SIZE		
Text 2	SMALL SIZE		
			<pre> MC #01 REG C01 31-10-2004 03:00 PM 001082 1 PLU001 -46.00 MEDIUM SIZE 1 PLU002 -10.00 SMALL SIZE TL -56.00 CASH -56.00 </pre>

Advanced Operations

Deposit registrations

Use the following procedures to register deposits.

Deposit from customer

OPERATION

Deposit	Cash	\$50.00
---------	------	---------

5 0 00 DEPOSIT -

CA/AMT /TEND

PRINTOUT (by optional remote printer)

		MC #01
REG C01	31-10-2004 03:05 PM	001083
DEPO-		.50.00
TL		- 50.00
CASH		.50.00

Deposit from customer during sales transaction

OPERATION

Items	Flat 1	\$10.00
	Flat 2	\$20.00
Deposit		\$20.00
Payment	Cash	\$10.00

1 0 00 PLU 001

2 0 00 PLU 002

2 0 00 DEPOSIT +

CA/AMT /TEND

PRINTOUT (by optional remote printer)

		MC #01
REG C01	31-10-2004 03:10 PM	001084
1 PLU001		.10.00
1 PLU002		.20.00
DEPO+		-20.00
TL		- 10.00
CASH		.10.00

- You can select "DEPO+" or "DEPO-" by programming.

List-# registrations

By using <LIST-#>, you can register the item by selecting items in the "LIST" pop-up window.

Example

OPERATION

List-10	
1. PLU0010	\$1.00
2. PLU0012	\$2.00
3. PLU0015	\$5.00
4. PLU0100	\$1.25
5. PLU0111	\$12.98

1 0 LIST#

Touch the appropriate item in the "LIST" pop-up window.

CA/AMT /TEND

DISPLAY

See page 18 of this manual.

Item	PLU0015	\$5.00
	Quantity	1
Payment	Cash	\$5.00

PRINTOUT (by optional remote printer)

		MC #01
REG C01	31-10-2004 03:15 PM	001085
1 PLU015		.5.00
TL		- 5.00
CASH		.5.00

Bill copy

Example

To issue a copy of a bill dated September 30, 2004 in the amount of \$35.00 cash.

OPERATION	PRINTOUT (by optional remote printer)
<div style="display: flex; justify-content: space-around; align-items: center;"> <div style="display: flex; gap: 5px;"> <div style="border: 1px solid black; padding: 2px 5px;">3</div> <div style="border: 1px solid black; padding: 2px 5px;">0</div> <div style="border: 1px solid black; padding: 2px 5px;">0</div> <div style="border: 1px solid black; padding: 2px 5px;">9</div> <div style="border: 1px solid black; padding: 2px 5px;">0</div> <div style="border: 1px solid black; padding: 2px 5px;">4</div> </div> <div style="border: 1px solid black; padding: 2px 5px; font-size: 8px;">BILL COPY</div> </div> <p style="text-align: center; margin-top: 5px;">Enter date by date order.</p> <div style="display: flex; justify-content: space-around; align-items: center; margin-top: 10px;"> <div style="display: flex; gap: 5px;"> <div style="border: 1px solid black; padding: 2px 5px;">3</div> <div style="border: 1px solid black; padding: 2px 5px;">5</div> <div style="border: 1px solid black; padding: 2px 5px;">00</div> </div> <div style="border: 1px solid black; padding: 2px 5px; font-size: 8px;">CA/AMT /TEND</div> </div>	<pre> ***** BILL TOP MESSAGE 1 ***** ***** BILL TOP MESSAGE 2 ***** ***** BILL TOP MESSAGE 3 ***** ***** BILL TOP MESSAGE 4 ***** </pre> <p style="text-align: right; margin-right: 10px;">Bill top message *1</p> <pre> REG C01 30-09-2004 MC #01 ***** BILL COPY MESSAGE 1 ***** ***** BILL COPY MESSAGE 2 ***** ***** BILL COPY MESSAGE 3 ***** ***** BILL COPY MESSAGE 4 ***** </pre> <p style="text-align: right; margin-right: 10px;">Bill copy message *1</p> <pre> TA1 .35.00 TX1 .3.50 TL -38.50 CASH .38.50 </pre> <p style="text-align: right; margin-right: 10px;">Add-on tax amount</p> <pre> ***** BILL BTM MESSAGE 1 ***** ***** BILL BTM MESSAGE 2 ***** ***** BILL BTM MESSAGE 3 ***** ***** BILL BTM MESSAGE 4 ***** </pre> <p style="text-align: right; margin-right: 10px;">Bill bottom message *1</p>

*1 Programmable option

Note that you can finalize this operation using the cash amount tendered key.

Tray total

Multiple item totalling function

This function accumulates all items registered from the first item registered up to point that <TRAY TOTAL> is pressed two times, or all items between two presses of <TRAY TOTAL> . Pressing <TRAY TOTAL> two times displays the total amount with the tax included and prints it on the receipt and journal (printing on receipt and journal is programmable.)

Example

			OPERATION	PRINTOUT (by optional remote printer)																														
CustomerA	Flat 1	\$1.00	1 00 PLU 001	<table border="1"> <tr> <td colspan="2"></td> <td style="text-align: right;">MC #01</td> </tr> <tr> <td>REG</td> <td>C01</td> <td>31-10-2004 03:20 PM 001086</td> </tr> <tr> <td>1</td> <td>PLU001</td> <td style="text-align: right;">.1.00</td> </tr> <tr> <td>1</td> <td>PLU003</td> <td style="text-align: right;">.2.00</td> </tr> <tr> <td></td> <td>TRAY TL</td> <td style="text-align: right;">-3.00</td> </tr> <tr> <td>1</td> <td>PLU003</td> <td style="text-align: right;">.3.00</td> </tr> <tr> <td>1</td> <td>PLU004</td> <td style="text-align: right;">.4.00</td> </tr> <tr> <td></td> <td>TRAY TL</td> <td style="text-align: right;">-7.00</td> </tr> <tr> <td></td> <td>TL</td> <td style="text-align: right;">-10.00</td> </tr> <tr> <td></td> <td>CASH</td> <td style="text-align: right;">.10.00</td> </tr> </table>			MC #01	REG	C01	31-10-2004 03:20 PM 001086	1	PLU001	.1.00	1	PLU003	.2.00		TRAY TL	-3.00	1	PLU003	.3.00	1	PLU004	.4.00		TRAY TL	-7.00		TL	-10.00		CASH	.10.00
			MC #01																															
REG	C01	31-10-2004 03:20 PM 001086																																
1	PLU001	.1.00																																
1	PLU003	.2.00																																
	TRAY TL	-3.00																																
1	PLU003	.3.00																																
1	PLU004	.4.00																																
	TRAY TL	-7.00																																
	TL	-10.00																																
	CASH	.10.00																																
	Flat 3	\$2.00	2 00 PLU 003																															
			TRAY TOTAL TRAY TOTAL																															
CustomerB	Flat 3	\$3.00	3 00 PLU 003																															
	Flat 4	\$4.00	4 00 PLU 004																															
			TRAY TOTAL TRAY TOTAL																															
Payment	Cash	\$10.00	CA/AMT TEND																															

Set menu

When you register a set menu, the unit price of the parent PLU is used. The price of each set menu item is also added to each respective PLU totalizer and counter.

Example

Set menu	Flat 4	\$5.00
Item 1	PLU 31	\$2.00
Item 2	PLU 32	\$2.00
Item 3	PLU 33	\$1.00
Item 4	PLU 34	\$1.00
Payment	Cash	\$5.00

OPERATION

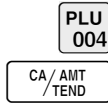

PRINTOUT (by optional remote printer)

```

MC #01
REG C01 31-10-2004 03:25 PM 001087
1 PLU004 -5.00
  PLU031
  PLU032
  PLU033
  PLU034
TL -5.00
CASH -5.00
  
```

Tips

Example

Item 1	Flat 1	\$3.00
	Quantity	1
Item 2	Flat 2	\$5.00
	Quantity	1
Tip	Amount	\$0.80
Payment	Cash	\$10.00

OPERATION

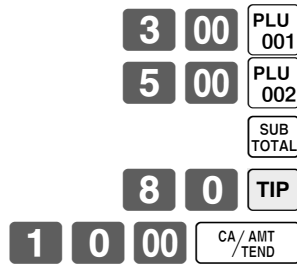

PRINTOUT (by optional remote printer)

```

MC #01
REG C01 31-10-2004 03:30 PM 001088
1 PLU001 -3.00
1 PLU002 -5.00
TIP -0.80
TL -8.80
CASH -10.00
CG -1.20
  
```

Stock check

Each PLU has an actual stock totalizer that you can program with a minimum stock quantity. The terminal checks actual stock quantities against the programmed minimum stock quantities. Stock operations are performed only for PLUs programmed with minimum stock quantities.

Stock warnings

When the minimum stock value of an item is set, the terminal subtracts its stock quantity from the registered quantity (or registered quantity × unit stock).

The following warning indicates stock problem to the operator.

- **Negative stock:**
This indicates that the actual stock quantity is negative. The terminal to treat this condition as an error.
- **Under minimum stock:**
This indicates that the actual stock quantity is less than the minimum stock quantity. The terminal sounds buzzer when the actual stock quantity is less than the minimum stock quantity.

Notes

- None of the warning indicators appear unless the terminal is specifically programmed for the stock check operation.
- Stock operations can be performed for registrations in the REF mode or those performed with <REFUND> (the refund key).
- An error correct, void, or cancel operation restores the original value of items back in stock value. (You can change the stock calculation formula of REF mode, <REFUND> or <VOID> by programming.)

Actual stock quantity inquiry

With this operation, you can recall the actual stock quantity for PLUs and show it on the display of the terminal.

Example

To inquire the actual stock quantity of flat-PLU 001.

OPERATION

DISPLAY

STOCK
INQ
PLU
001

The terminal display shows the following information:

REG C01	31-10-04 03:30 PM 001580
PLU001	10.05

Actual stock quantity

Single item cash sales

A department key, subdepartment or PLU programmed with single item sale status finalizes the transaction as soon as it is registered.

The single item sales function cannot work properly if the keyboard does not include <CASH> (the cash key). The single item sales function can only be used for cash sales.

Example 1

	OPERATION	PRINTOUT (by optional remote printer)												
<table border="1" style="width: 100%; border-collapse: collapse;"> <tr> <td style="width: 15%;"></td> <td style="width: 30%;">Flat 1</td> <td style="width: 15%; text-align: right;">\$1.00</td> </tr> <tr> <td style="text-align: center;">Item</td> <td style="text-align: center;">Quantity</td> <td style="text-align: center;">1</td> </tr> <tr> <td></td> <td style="text-align: center;">Status</td> <td style="text-align: center;">S.I.S</td> </tr> <tr> <td style="text-align: center;">Payment</td> <td style="text-align: center;">Cash</td> <td style="text-align: right;">\$1.00</td> </tr> </table>		Flat 1	\$1.00	Item	Quantity	1		Status	S.I.S	Payment	Cash	\$1.00	<div style="display: flex; justify-content: center; gap: 10px; align-items: center;"> <div style="border: 1px solid black; padding: 2px 5px; font-weight: bold; font-size: 1.2em;">1</div> <div style="border: 1px solid black; padding: 2px 5px; font-weight: bold; font-size: 1.2em;">00</div> <div style="border: 1px solid black; padding: 2px 5px; font-weight: bold; font-size: 0.8em;">PLU 001</div> </div> <p>The transaction is immediately finalized.</p>	<div style="border: 1px solid black; padding: 5px; font-family: monospace; font-size: 0.8em;"> <div style="text-align: right; margin-bottom: 5px;">MC #01</div> REG C01 31-10-2004 03:35 PM 001089 1 PLU001 .1.00 TL - 1.00 CASH .1.00 </div>
	Flat 1	\$1.00												
Item	Quantity	1												
	Status	S.I.S												
Payment	Cash	\$1.00												

Example 2

	OPERATION	PRINTOUT (by optional remote printer)												
<table border="1" style="width: 100%; border-collapse: collapse;"> <tr> <td style="width: 15%;"></td> <td style="width: 30%;">Flat 1</td> <td style="width: 15%; text-align: right;">(\$1.00)</td> </tr> <tr> <td style="text-align: center;">Item</td> <td style="text-align: center;">Quantity</td> <td style="text-align: center;">3</td> </tr> <tr> <td></td> <td style="text-align: center;">Status</td> <td style="text-align: center;">S.I.S</td> </tr> <tr> <td style="text-align: center;">Payment</td> <td style="text-align: center;">Cash</td> <td style="text-align: right;">\$3.00</td> </tr> </table>		Flat 1	(\$1.00)	Item	Quantity	3		Status	S.I.S	Payment	Cash	\$3.00	<div style="display: flex; justify-content: center; gap: 10px; align-items: center;"> <div style="border: 1px solid black; padding: 2px 5px; font-weight: bold; font-size: 1.2em;">3</div> <div style="border: 1px solid black; padding: 2px 5px; font-weight: bold; font-size: 1.2em;">X</div> <div style="border: 1px solid black; padding: 2px 5px; font-weight: bold; font-size: 0.8em;">PLU 001</div> </div> <p>The transaction is immediately finalized.</p>	<div style="border: 1px solid black; padding: 5px; font-family: monospace; font-size: 0.8em;"> <div style="text-align: right; margin-bottom: 5px;">MC #01</div> REG C01 31-10-2004 03:40 PM 001090 3 PLU001 .3.00 TL - 3.00 CASH .3.00 </div>
	Flat 1	(\$1.00)												
Item	Quantity	3												
	Status	S.I.S												
Payment	Cash	\$3.00												

Example 3

	OPERATION	PRINTOUT (by optional remote printer)																					
<table border="1" style="width: 100%; border-collapse: collapse;"> <tr> <td style="width: 15%;"></td> <td style="width: 30%;">Flat 4</td> <td style="width: 15%; text-align: right;">\$2.00</td> </tr> <tr> <td style="text-align: center;">Item 1</td> <td style="text-align: center;">Quantity</td> <td style="text-align: center;">1</td> </tr> <tr> <td></td> <td style="text-align: center;">Status</td> <td style="text-align: center;">Normal</td> </tr> <tr> <td style="text-align: center;">Item 2</td> <td style="text-align: center;">Flat 1</td> <td style="text-align: right;">\$1.00</td> </tr> <tr> <td></td> <td style="text-align: center;">Quantity</td> <td style="text-align: center;">1</td> </tr> <tr> <td></td> <td style="text-align: center;">Status</td> <td style="text-align: center;">S.I.S</td> </tr> <tr> <td style="text-align: center;">Payment</td> <td style="text-align: center;">Cash</td> <td style="text-align: right;">\$3.00</td> </tr> </table>		Flat 4	\$2.00	Item 1	Quantity	1		Status	Normal	Item 2	Flat 1	\$1.00		Quantity	1		Status	S.I.S	Payment	Cash	\$3.00	<div style="display: flex; justify-content: center; gap: 10px; align-items: center;"> <div style="border: 1px solid black; padding: 2px 5px; font-weight: bold; font-size: 1.2em;">2</div> <div style="border: 1px solid black; padding: 2px 5px; font-weight: bold; font-size: 1.2em;">00</div> <div style="border: 1px solid black; padding: 2px 5px; font-weight: bold; font-size: 0.8em;">PLU 004</div> <div style="border: 1px solid black; padding: 2px 5px; font-weight: bold; font-size: 0.8em;">PLU 001</div> </div> <p>The transaction is not finalized. Because another item is registered before the single item sales.</p> <div style="border: 1px solid black; padding: 2px 5px; font-size: 0.8em; margin-top: 10px;">CA/AMT /TEND</div>	<div style="border: 1px solid black; padding: 5px; font-family: monospace; font-size: 0.8em;"> <div style="text-align: right; margin-bottom: 5px;">MC #01</div> REG C01 31-10-2004 03:40 PM 001090 1 PLU004 .2.00 1 PLU001 .1.00 TL - 3.00 CASH .3.00 </div>
	Flat 4	\$2.00																					
Item 1	Quantity	1																					
	Status	Normal																					
Item 2	Flat 1	\$1.00																					
	Quantity	1																					
	Status	S.I.S																					
Payment	Cash	\$3.00																					

Advanced Operations

Addition

Addition (plus)

Example

Item 1	Flat 1	\$1.00
	Quantity	1
	Addition	\$0.10
Item 2	Flat 1	\$2.00
	Quantity	3
	Addition	3 × (\$0.20)
Payment	Cash	\$7.70

OPERATION

1 **00** **PLU 001**
1 **0** **+**
3 **X**
2 **00** **PLU 001**
3 **X**
+
CA/AMT TEND

PRINTOUT (by optional remote printer)

```

MC #01
REG C01 31-10-2004 03:50 PM 001100
1 PLU001 .1.00
+ .0.10
3 PLU001 .6.00
+ .0.60
TL -7.70
CASH -7.70
    
```

Premium (%+)

Example

Item 1	Flat 1	\$1.00
	Quantity	1
	Premium	10%
Item 2	Flat 1	\$2.00
	Quantity	3
Subtotal	Premium	(15%)
Payment	Cash	\$8.17

OPERATION

1 **00** **PLU 001**
1 **0** **%+**
3 **X**
2 **00** **PLU 001**
SUB TOTAL
%+
CA/AMT TEND

PRINTOUT (by optional remote printer)

```

MC #01
REG C01 31-10-2004 03:50 PM 001101
1 PLU001 .1.00
10%
%+ .0.10
3 PLU001 .6.00
ST .7.10
15%
%+ .1.07
TL -8.17
CASH -8.17
    
```

Coupon transactions

Note that error occurs when the result of the coupon (not coupon 2) registration is negative, if the terminal is programmed to prohibit credit balances.

Coupon registration using <COUPON> (coupon key)

Example

Item 1	Flat 1	\$3.00
	Quantity	2
	Coupon	\$0.50 × 2
Item 2	Flat 3	\$4.00
	Quantity	1
	Coupon	(\$1.00)
Payment	Cash	\$8.00

OPERATION

2 X

3 00 PLU 001

2 X

5 0 CPN

4 00 PLU 003

CPN

CA/AMT TEND

PRINTOUT
(by optional remote printer)

```

MC #01
REG C01 31-10-2004 04:00 PM 001110
2 PLU001          -6.00
  COUPON          -1.00
1 PLU003          -4.00
  COUPON          -1.00
  TL              - 8.00
  CASH            -8.00
    
```

Coupon registration using <CPN2> (coupon 2 key)

Example

Item 1	Flat 1	\$15.00
	Quantity	1
	Coupon 2 Flat 1	\$1.50
Item 2	Flat 2	\$5.00
	Quantity	1
	Coupon 2 Flat 2	(\$0.50)
Payment	Cash	\$18.00

OPERATION

CPN2 1 5 00 PLU 001

CPN2 1 5 0 PLU 001

5 00 PLU 002

CPN2 5 0 PLU 002

CA/AMT TEND

PRINTOUT
(by optional remote printer)

```

MC #01
REG C01 31-10-2004 04:05 PM 001111
1 PLU001          -15.00
  CPN2            .....
1 PLU001          -1.50
1 PLU002          -5.00
  CPN2            .....
1 PLU002          -0.50
  TL              -18.00
  CASH            -18.00
    
```

Registering the second unit price

Second unit prices along with quantity modifiers can be programmed to PLUs. Pressing <1st@> (1st unit price key)/<2nd@> (2nd unit price key) calls up the first/second unit price, quantity modifier, and descriptor.

Totalizers and inventory are adjusted by multiplying the number of items being registered by the quantity modifier programmed to the PLU being registered.

- <1st@> or <2nd@> must be pressed before each registration of a PLU.
- Second unit price registration is not available with open PLUs when unit price is not preset.
- Second unit prices and quantity modifiers are assigned to PLUs using programming procedures described in the programming manual.

Example 1

	OPERATION	PRINTOUT (by optional remote printer)																																																								
<table border="1" style="width: 100%; border-collapse: collapse;"> <tr> <td rowspan="3" style="text-align: center;">Item 1</td> <td style="text-align: center;">Flat 1_{2nd@}</td> <td style="text-align: center;">(\$10.00)</td> </tr> <tr> <td style="text-align: center;">Quantity</td> <td style="text-align: center;">1</td> </tr> <tr> <td style="text-align: center;">2nd Q'ty</td> <td style="text-align: center;">1</td> </tr> <tr> <td rowspan="3" style="text-align: center;">Item 2</td> <td style="text-align: center;">PLU 10_{2nd@}</td> <td style="text-align: center;">(\$5.00)</td> </tr> <tr> <td style="text-align: center;">Quantity</td> <td style="text-align: center;">1</td> </tr> <tr> <td style="text-align: center;">2nd Q'ty</td> <td style="text-align: center;">1</td> </tr> <tr> <td style="text-align: center;">Payment</td> <td style="text-align: center;">Cash</td> <td style="text-align: center;">\$15.00</td> </tr> </table>	Item 1	Flat 1 _{2nd@}	(\$10.00)	Quantity	1	2nd Q'ty	1	Item 2	PLU 10 _{2nd@}	(\$5.00)	Quantity	1	2nd Q'ty	1	Payment	Cash	\$15.00	<div style="text-align: center;"> 2nd@ PLU 001 </div> <p>The operation declares that the next input is a second unit price.</p> <div style="text-align: center;"> 2nd@ 1 0 PLU </div> <div style="text-align: center; margin-top: 10px;"> SUB TOTAL </div> <div style="text-align: center; margin-top: 10px;"> CA / AMT / TEND </div>	<table border="1" style="width: 100%; border-collapse: collapse;"> <tr> <td style="width: 15%;"></td> <td style="width: 15%;"></td> <td style="width: 15%;"></td> <td style="width: 15%;"></td> <td style="width: 15%;"></td> <td style="width: 15%;"></td> </tr> <tr> <td></td> <td></td> <td></td> <td></td> <td style="text-align: right;">MC #01</td> <td></td> </tr> <tr> <td>REG</td> <td>C01</td> <td>31-10-2004</td> <td>04:10 PM</td> <td>001112</td> <td></td> </tr> <tr> <td>1</td> <td>PLU001</td> <td></td> <td></td> <td style="text-align: right;">·10.00</td> <td rowspan="4" style="vertical-align: middle; padding-left: 10px;">2nd@ descriptor/ amount</td> </tr> <tr> <td>1</td> <td>PLU010</td> <td></td> <td></td> <td style="text-align: right;">·5.00</td> </tr> <tr> <td></td> <td>TL</td> <td></td> <td></td> <td style="text-align: right;">- 15.00</td> </tr> <tr> <td></td> <td>CASH</td> <td></td> <td></td> <td style="text-align: right;">·15.00</td> </tr> </table>											MC #01		REG	C01	31-10-2004	04:10 PM	001112		1	PLU001			·10.00	2nd@ descriptor/ amount	1	PLU010			·5.00		TL			- 15.00		CASH			·15.00
Item 1		Flat 1 _{2nd@}	(\$10.00)																																																							
		Quantity	1																																																							
	2nd Q'ty	1																																																								
Item 2	PLU 10 _{2nd@}	(\$5.00)																																																								
	Quantity	1																																																								
	2nd Q'ty	1																																																								
Payment	Cash	\$15.00																																																								
				MC #01																																																						
REG	C01	31-10-2004	04:10 PM	001112																																																						
1	PLU001			·10.00	2nd@ descriptor/ amount																																																					
1	PLU010			·5.00																																																						
	TL			- 15.00																																																						
	CASH			·15.00																																																						

Example 2

	OPERATION	PRINTOUT (by optional remote printer)																																																	
<table border="1" style="width: 100%; border-collapse: collapse;"> <tr> <td rowspan="3" style="text-align: center;">Item</td> <td style="text-align: center;">Flat 2_{2nd@}</td> <td style="text-align: center;">(\$10.00)</td> </tr> <tr> <td style="text-align: center;">Quantity</td> <td style="text-align: center;">5</td> </tr> <tr> <td style="text-align: center;">2nd Q'ty</td> <td style="text-align: center;">3</td> </tr> <tr> <td style="text-align: center;">Payment</td> <td style="text-align: center;">Cash</td> <td style="text-align: center;">\$50.00</td> </tr> </table>	Item	Flat 2 _{2nd@}	(\$10.00)	Quantity	5	2nd Q'ty	3	Payment	Cash	\$50.00	<div style="text-align: center;"> 5 X </div> <div style="text-align: center; margin-top: 10px;"> 2nd@ PLU 002 </div> <div style="text-align: center; margin-top: 10px;"> 5 0 00 CA / AMT / TEND </div>	<table border="1" style="width: 100%; border-collapse: collapse;"> <tr> <td style="width: 15%;"></td> <td style="width: 15%;"></td> <td style="width: 15%;"></td> <td style="width: 15%;"></td> <td style="width: 15%;"></td> <td style="width: 15%;"></td> </tr> <tr> <td></td> <td></td> <td></td> <td></td> <td style="text-align: right;">MC #01</td> <td></td> </tr> <tr> <td>REG</td> <td>C01</td> <td>31-10-2004</td> <td>04:15 PM</td> <td>001113</td> <td></td> </tr> <tr> <td>5</td> <td>PLU002</td> <td></td> <td></td> <td style="text-align: right;">·50.00</td> <td rowspan="4"></td> </tr> <tr> <td></td> <td>TL</td> <td></td> <td></td> <td style="text-align: right;">- 50.00</td> </tr> <tr> <td></td> <td>CASH</td> <td></td> <td></td> <td style="text-align: right;">·50.00</td> </tr> <tr> <td></td> <td>CG</td> <td></td> <td></td> <td style="text-align: right;">·0.00</td> </tr> </table>											MC #01		REG	C01	31-10-2004	04:15 PM	001113		5	PLU002			·50.00			TL			- 50.00		CASH			·50.00		CG			·0.00
Item		Flat 2 _{2nd@}	(\$10.00)																																																
		Quantity	5																																																
	2nd Q'ty	3																																																	
Payment	Cash	\$50.00																																																	
				MC #01																																															
REG	C01	31-10-2004	04:15 PM	001113																																															
5	PLU002			·50.00																																															
	TL			- 50.00																																															
	CASH			·50.00																																															
	CG			·0.00																																															

Example 3

The procedure shown on the previous page applies when the terminal is programmed not to maintain the 1st/2nd price shift. When the terminal is programmed to maintain the 1st/2nd price shift, the procedure below applies.

OPERATION PRINTOUT (by optional remote printer)

Item 1	Flat 1 _{2nd@}	(\$10.00)
	Quantity	1
	2nd Q'ty	1
Item 2	Flat 2 _{2nd@}	(\$5.00)
	Quantity	1
	2nd Q'ty	1
Item 3	Flat 1	(\$1.00)
	Quantity	1
	2nd Q'ty	1
Payment	Cash	\$16.00

2nd@ PLU
001
 This operation shifts to registration of second unit price.

PLU
002
1st@ PLU
001
 This operation shifts to registration of normal (first) unit price.

		MC #01
REG	C01	31-10-2004 04:20 PM 001114
1	PLU001	.10.00
1	PLU002	.5.00
1	PLU001	.1.00
	TL	- 16.00
	CASH	.16.00
	CG	.0.00

1 6 00 CA/AMT
/TEND

Preset tender amount

An amount up to six digits long can be programmed to <CASH> (cash/amount tendered key). Then, when <CASH> is pressed without inputting a value, the programmed value is automatically registered and the transaction is finalized. When an amount is programmed to <CASH>, attempting to manually input an amount results in an error.

Example 1

Item	Flat 1	\$8.00
	Quantity	1
Payment	Cash	(\$10.00)

OPERATION

8 00 PLU 001

CA/AMT
TEND

The preset amount is tendered.

PRINTOUT (by optional remote printer)

```

MC #01
REG C01 31-10-2004 04:30 PM 001120
1 PLU001          .8.00
  TL              -8.00
  CASH            -10.00
  CG              -2.00
    
```

Example 2

Item	Flat 1	\$15.00
	Quantity	1
Payment	Check	\$5.00
	Cash	(\$10.00)

OPERATION

1 5 00 PLU 001
1 0 00 CA/AMT
TEND

An error occurs by manual input

(C)

5 00 CHK/
TEND

CA/AMT
TEND

PRINTOUT (by optional remote printer)

```

MC #01
REG C01 31-10-2004 04:35 PM 001121
1 PLU001          -15.00
  TL              -15.00
  CHECK           -5.00
  CASH            -10.00
  CG              -0.00
    
```

Arrangement key registrations

Key (job/command) operations can be assigned to an <ARRANGE> (arrangement key). Then, simply pressing <ARRANGE> performs all of the key functions assigned to it.

Example

OPERATION **PRINTOUT**
(by optional remote printer)

Arrangement 1		
Item 1	PLU 10	(\$8.00)
	Quantity	1
Item 2	PLU 20	(\$5.00)
	Quantity	1
Payment	Cash	\$13.00

ARR

		MC #01
REG	C01	31-10-2004 04:45 PM 001130
1	PLU010	.8.00
1	PLU020	.5.00
	TL	- 13.00
	CASH	.13.00



Currency exchange function

When <CE> (currency exchange key) and <ST> are pressed, a current subtotal including tax is converted into foreign currency and the result is displayed.

Before using the currency exchange function, it is necessary to program the conversion rate and foreign currency amount symbol.

Registering foreign currency

Full amount tender in a foreign currency

* Pre-programmed exchange rate: ¥ 100 = \$0.9524

Important!

Tenders in a foreign currency can be registered using the **CA/AMT/TEND** and **CHK/TEND** only. Other finalize keys cannot be used.

OPERATION

1 0 00 **PLU 001** ← Enter the unit price and press the applicable flat-PLU key.

2 0 00 **PLU 002** ← Enter the next unit price and press the applicable flat-PLU key.

CE **SUB TOTAL** ← Press **CE** and **SUB TOTAL** without entering a numeric value. This operation converts the subtotal (including tax) dollar value into yen by applying a pre-programmed exchange rate. The result is shown on the display and printed on the receipt/journal by programming.

CE **5 0 00** ← Press **CE** and enter the amount tendered in yen. This operation converts the entered yen amount into dollars by applying a pre-programmed exchange rate. The result is shown on the display.
(¥5,000)

CA/AMT/TEND ← Press to finalize the transaction. Note that you do not need to reenter the dollar amount. The terminal automatically calculates the change amount due in dollars and shows it on the display, receipts and journal.

DISPLAY

REG	C01	31-10-04	05:00 PM	001150
1	PLU001			· 10.00
1	PLU002			· 20.00
	TL			· 30.00
	CE			
	CASH			¥5,000
	CASH			· 47.62
	CG			· 17.62
CG				· 17.62

PRINTOUT

(by optional remote printer)

REG	C01	31-10-2004	05:00 PM	001150	MC #01
1	PLU001				· 10.00
2	PLU002				· 20.00
	TL				· 30.00
	CE				
	CASH				¥5,000
	CASH				· 47.62
	CG				· 17.62

Partial tender in a foreign currency

* Pre-programmed exchange rate: ¥ 100 = \$0.9524

Important!

Tender in a foreign currency can be registered using **CA/AMT/TEND** and **CHK/TEND** only. Other finalization keys cannot be used, but the remaining tender in local currency can be finalized using any finalize key.

OPERATION

1 0 00 **PLU 001** ← Enter the unit price and press the applicable flat-PLU key.

2 0 00 **PLU 002** ← Enter the next unit price and press the applicable flat-PLU key.

CE **SUB TOTAL** ← Press **CE** and **SUB TOTAL** without entering a numeric value. This operation converts the subtotal (including tax) dollar value into yen by applying a pre-programmed exchange rate. The result is shown on the display and printed on the receipt/journal by programming.

CE **2 0 00** ← Press **CE** and enter the partial amount tendered in yen.
(¥2,000)

This operation converts the entered yen amount into dollars by applying a pre-programmed exchange rate. The result is shown on the display.

CA/AMT/TEND ← Press **CA/AMT/TEND** to specify cash tender for the yen partial tender. Note that you do not need to reenter the dollar amount.

The terminal automatically deducts the dollar equivalent of the yen amount tendered from the total amount due and shows the rest amount on the display.

CHK/TEND ← Press to finalize the transaction.

DISPLAY

REG	C01	31-10-04 05:05 PM 001151
1	PLU001	· 10.00
1	PLU002	· 20.00
	TL	· 30.00
	CE	
	CASH	¥2,000
	CASH	· 19.05
	CHECK	· 10.95
CHK		· 10.95

PRINTOUT (by optional remote printer)

		MC #01
REG	C01	31-10-2004 05:05 PM 001151
1	PLU001	· 10.00
1	PLU002	· 20.00
	TL	· 30.00
	CE	
	CASH	¥2,000
	CASH	· 19.05
	CHECK	· 10.95

Temporarily releasing compulsion

<OPEN> (open key) can release HDL (High Digit Limitation)/LDL (Low Digit Limitation) and can be programmed to release HAL (High Amount Limit).

<OPEN 2> (open 2 key) can be programmed to release specific compulsion.

Example 1

Item	Flat 1	\$10.00
	HAL	\$1.00
Payment	Cash	\$10.00

OPERATION

1 0 00

ERROR occur

*

1 0 00

PRINTOUT (by optional remote printer)

```

MC #01
REG C01 31-10-2004 05:15 PM 001160
1 PLU001          -10.00
  TL              - 10.00
  CASH            -10.00
    
```

* In this case, should be programmed to “release high amount limit”.

Example 2

Input check No. compulsory		
Item	Flat 1	\$10.00
	Quantity	1
Payment	Check	\$10.00

OPERATION

1 0 00

ERROR occur

Input check No. compulsory

Compulsory is temporarily released.

1 0 00

1 0 00

PRINTOUT (by optional remote printer)

```

MC #01
REG C01 31-10-2004 05:20 PM 001161
1 PLU001          -10.00
  TL              - 10.00
  CHECK           -10.00
  CG               -0.00
    
```

VAT breakdown printing

You can force printing of the VAT breakdown at the finalize stage, regardless of whether the terminal is programmed to print or skip printing of the VAT breakdown. Every time you want to have VAT breakdown, press <VAT>.

Example

OPERATION			PRINTOUT (by optional remote printer)																						
Item 1	Flat 1	\$1.00	1 00	PLU 001	<table style="width: 100%; border-collapse: collapse;"> <tr> <td colspan="2" style="text-align: right;">MC #01</td> </tr> <tr> <td>REG C01</td> <td style="text-align: right;">31-10-2004 05:20 PM 001161</td> </tr> <tr> <td>1 PLU001</td> <td style="text-align: right;">.1.00 T1</td> </tr> <tr> <td>1 PLU002</td> <td style="text-align: right;">.2.00 T2</td> </tr> <tr> <td>TA1</td> <td style="text-align: right;">.0.90</td> </tr> <tr> <td>TX1</td> <td style="text-align: right;">.0.10</td> </tr> <tr> <td>TA2</td> <td style="text-align: right;">.1.90</td> </tr> <tr> <td>TX2</td> <td style="text-align: right;">.0.10</td> </tr> <tr> <td>TL</td> <td style="text-align: right;">.3.00</td> </tr> <tr> <td>CASH</td> <td style="text-align: right;">.3.00</td> </tr> </table>	MC #01		REG C01	31-10-2004 05:20 PM 001161	1 PLU001	.1.00 T1	1 PLU002	.2.00 T2	TA1	.0.90	TX1	.0.10	TA2	.1.90	TX2	.0.10	TL	.3.00	CASH	.3.00
	MC #01																								
REG C01	31-10-2004 05:20 PM 001161																								
1 PLU001	.1.00 T1																								
1 PLU002	.2.00 T2																								
TA1	.0.90																								
TX1	.0.10																								
TA2	.1.90																								
TX2	.0.10																								
TL	.3.00																								
CASH	.3.00																								
Taxable	1	2 00	PLU 002																						
Item 2	Flat 2			\$2.00	VAT																				
Taxable	2	CA / AMT TEND																							
Payment	Cash		\$3.00																						

Advanced Operations

Registering loan amounts

Use this procedure to register loan or bank received from the office.

	OPERATION	PRINTOUT (by optional remote printer)												
<table border="1" style="width: 100%; border-collapse: collapse;"> <tr> <td rowspan="4" style="text-align: center; vertical-align: middle;">Item</td> <td>Note</td> <td style="text-align: right;">\$1.00</td> </tr> <tr> <td>Quantity</td> <td style="text-align: center;">10</td> </tr> <tr> <td>Note</td> <td style="text-align: right;">\$5.00</td> </tr> <tr> <td>Quantity</td> <td style="text-align: center;">5</td> </tr> <tr> <td>Media</td> <td>Cash</td> <td style="text-align: right;">\$35.00</td> </tr> </table>	Item	Note	\$1.00	Quantity	10	Note	\$5.00	Quantity	5	Media	Cash	\$35.00	<div style="display: flex; flex-direction: column; align-items: center; gap: 5px;"> <div style="display: flex; gap: 5px;"> 1 0 X </div> <div style="display: flex; gap: 5px;"> 1 00 LOAN </div> <div style="display: flex; gap: 5px;"> 5 X </div> <div style="display: flex; gap: 5px;"> 5 00 LOAN </div> <div style="border: 1px solid black; padding: 2px 5px; margin-top: 5px;">CA/AMT TEND</div> </div>	<div style="border: 1px solid black; padding: 5px; width: fit-content; margin: auto;"> <p style="text-align: right; margin: 0;">MC #01</p> <p>REG C01 31-10-2004 05:30 PM 001180</p> <p style="margin-top: 10px;">LOAN -10.00</p> <p>LOAN -25.00</p> <p>CASH -35.00</p> </div>
Item		Note	\$1.00											
		Quantity	10											
		Note	\$5.00											
	Quantity	5												
Media	Cash	\$35.00												

Registering pick up amounts

Use this procedure to register pick up money from cash drawer.

	OPERATION	PRINTOUT (by optional remote printer)												
<table border="1" style="width: 100%; border-collapse: collapse;"> <tr> <td rowspan="4" style="text-align: center; vertical-align: middle;">Item</td> <td>Coin</td> <td style="text-align: right;">\$0.50</td> </tr> <tr> <td>Quantity</td> <td style="text-align: center;">10</td> </tr> <tr> <td>Coin</td> <td style="text-align: right;">\$0.10</td> </tr> <tr> <td>Quantity</td> <td style="text-align: center;">5</td> </tr> <tr> <td>Media</td> <td>Cash</td> <td style="text-align: right;">\$5.50</td> </tr> </table>	Item	Coin	\$0.50	Quantity	10	Coin	\$0.10	Quantity	5	Media	Cash	\$5.50	<div style="display: flex; flex-direction: column; align-items: center; gap: 5px;"> <div style="display: flex; gap: 5px;"> 1 0 X </div> <div style="display: flex; gap: 5px;"> 5 0 PICK UP </div> <div style="display: flex; gap: 5px;"> 5 X </div> <div style="display: flex; gap: 5px;"> 1 0 PICK UP </div> <div style="border: 1px solid black; padding: 2px 5px; margin-top: 5px;">CA/AMT TEND</div> </div>	<div style="border: 1px solid black; padding: 5px; width: fit-content; margin: auto;"> <p style="text-align: right; margin: 0;">MC #01</p> <p>REG C01 31-10-2004 05:35 PM 001181</p> <p style="margin-top: 10px;">P. UP -5.00</p> <p>P. UP -0.50</p> <p>CASH -5.50</p> </div>
Item		Coin	\$0.50											
		Quantity	10											
		Coin	\$0.10											
	Quantity	5												
Media	Cash	\$5.50												

Changing media in drawer

Use this procedure to change media in drawer.

	OPERATION	PRINTOUT (by optional remote printer)							
<table border="1" style="width: 100%; border-collapse: collapse;"> <tr> <td rowspan="3" style="text-align: center; vertical-align: middle;">Media</td> <td>Check</td> <td style="text-align: right;">-10.00</td> </tr> <tr> <td>Cash</td> <td style="text-align: right;">\$8.00</td> </tr> <tr> <td>Charge</td> <td style="text-align: right;">\$2.00</td> </tr> </table> <p style="margin-top: 10px; text-align: center;">Enter the amount to be changed.</p>	Media	Check	-10.00	Cash	\$8.00	Charge	\$2.00	<div style="display: flex; flex-direction: column; align-items: center; gap: 5px;"> <div style="display: flex; gap: 5px;"> 1 0 00 MEDIA CHANGE </div> <div style="display: flex; gap: 5px;"> 8 00 CHK/ TEND </div> <div style="border: 1px solid black; padding: 2px 5px; margin-top: 5px;">CA/AMT TEND</div> <div style="display: flex; gap: 5px;"> 2 00 CH </div> </div>	<div style="border: 1px solid black; padding: 5px; width: fit-content; margin: auto;"> <p style="text-align: right; margin: 0;">MC #01</p> <p>REG C01 31-10-2004 05:40 PM 001182</p> <p style="margin-top: 10px;">MEDIA CHG </p> <p>CHECK -10.00</p> <p>CASH -8.00</p> <p>CHARGE -2.00</p> </div>
Media		Check	-10.00						
		Cash	\$8.00						
	Charge	\$2.00							

Scanning PLU

Product barcodes are read by scanning with hand-held scanner, and are filed in the scanning PLU link file. The unit price, item descriptor, programming status, link department, totalizer and counter, the terminal are filed in the PLU link file.

When a barcode is entered by scanning, or from the keyboard by using <OBR> (OBR key), the terminal searches its scanning PLU link file and finds the preset unit price to accumulate to the PLU file.

Scanning PLUs include UPC-A/EAN-13/EAN-8, source marking, in-store marking code.

Item registration

By scanner/code input

Item 1 (scan)	Scan-PLU	(\$2.35)
	PLU code	49012347
Item 2 (code)	Scan-PLU	(\$2.00)
	PLU code	123456
Payment	Cash	\$5.00

OPERATION

“Scanning”

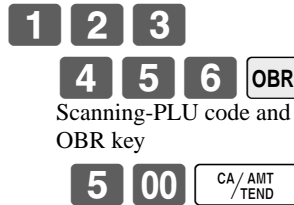

PRINTOUT (by optional remote printer)

		MC #01
REG	C01	31-10-2004 05:45 PM 001182
1	PLU100	.2.35
1	PLU101	.2.00
	TL	- 4.35
	CASH	.5.00
	CG	-.0.65

Unit price inquiry

Use this operation to recall the unit prices of departments, subdepartments, PLUs, second unit price of PLUs, or scanning PLUs.

The unit prices appear on the display of the terminal when recalled.

Example

To check the unit price of flat-PLU 001.

OPERATION

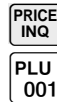

DISPLAY

REG	C01	31-10-04 05:30 PM 001162
1	PLU004	.10.00
1	PLU002	.20.00
PLU001		.10.00

Programming to clerk

You can program up to 4-digit clerk number (secret number), trainee status of clerk (i.e. training cashier) and clerk name (up to 16 characters) etc. for each clerk.

Programming procedure

- Step 1. Press **MODE** and <PGM3> icon to turn “PGM-3”, select “2.Clerk” **YES**, select “1.Clerk Feature” **YES**.
 Step 2. Select the appropriate clerk and press **YES**.

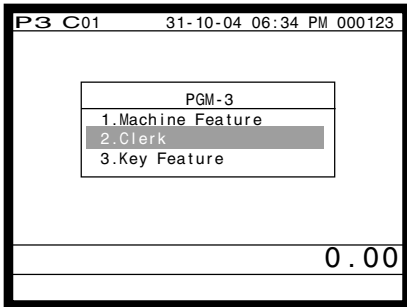

Step 1. screen

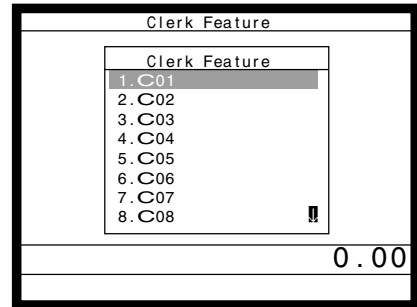

Step 2. screen

Step 3. Clerk descriptor programming:

Select “Descriptor” line, press **YES**, enter clerk name within 16 characters and **ENTER**.

Secret number programming:

Select “Secret number” line, and press **YES**, enter clerk secret number within 4 digits and **YES**.

Training status programming:

Select “Treat as Trainee” line, and select **YES** or **NO**.

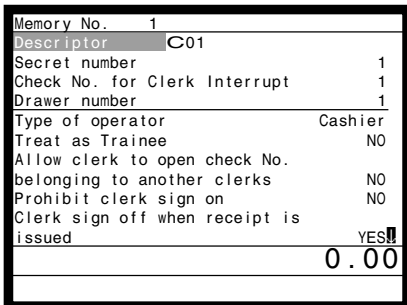

Step 3-1. screen

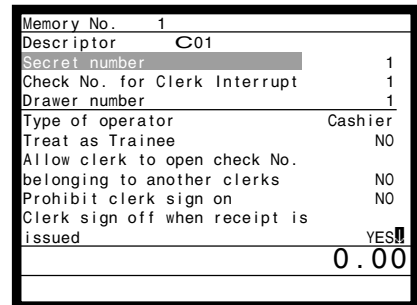

Step 3-2. screen

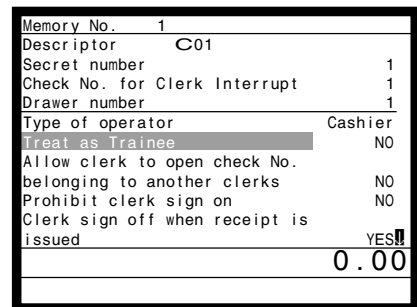

Step 3-3. screen

Step 4. Repeat the step 3., if you program the next record.

Press **ESC/SKIP** and repeat the step 2 and 3., if you program to the other record.

Step 5. Press **ESC/SKIP** repeatedly to return to the “Step 1. screen”.

Programming descriptors and messages

Programming item descriptor (flat-PLU) procedure

Step 1. Press **MODE** and <PGM2> icon to turn “PGM-2”, select “1.Item Descriptor” and press **YES**.

Step 2. Select “1.PLU” and press **YES**.

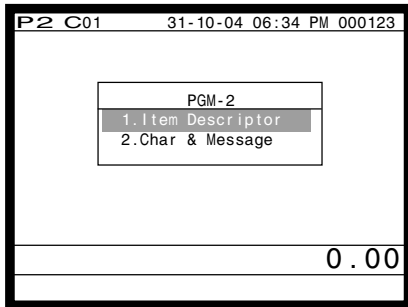

Step 1. screen

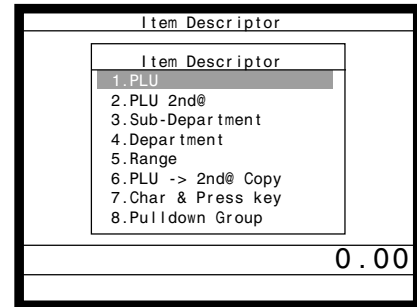

Step 2. screen

Step 3. Select the PLU record you want to program by pressing the flat-PLU key directly, by entering PLU record No. and **YES**, or by entering random PLU code and **PLU**.

Step 4. Enter characters and **ENTER**.

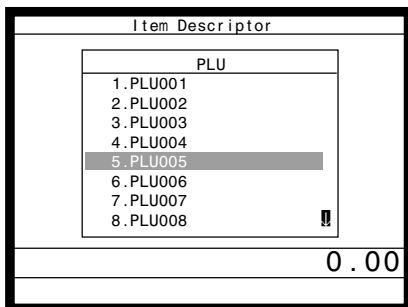

Step 3. screen

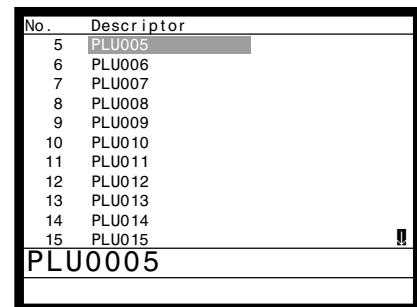

Step 4. screen

Step 5. Repeat the step 4., if you program the next record.

Press **ESC/SKIP** and repeat the step 3. and 4., if you program to the other record.

Step 6. Press **ESC/SKIP** repeatedly to return to the “Step 1. screen”.

Advanced Operations

Programming function key character procedure

Step 1. Press **MODE** and <PGM2> icon to turn “PGM-2”, select “1.Item Descriptor” and press **YES**.

Step 2. Select “7.Char & Press key” and press **YES**.

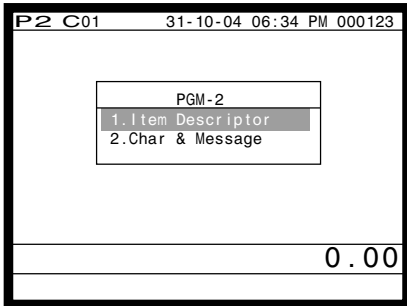

Step 1. screen

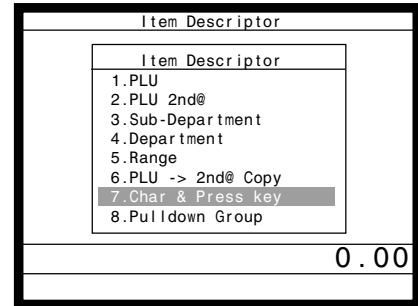

Step 2. screen

Step 3. Enter key characters, press **ENTER**, and press the corresponding key.

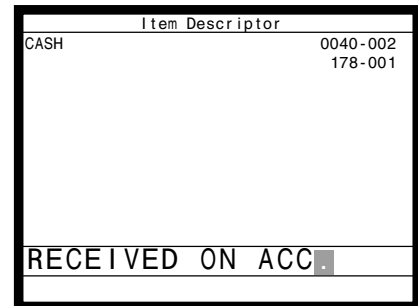

Step 3. screen

Step 4. Repeat the step 3., if you have other keys to program.

Step 5. Press **ESC/SKIP** repeatedly to return to the “Step 1. screen”.

The initial characters of function keys

Function	Code	Initial character	Function	Code	Initial character
Cash amount tendered	001	CASH	Non-add/No sale	041	#/NS
Charge	002	CHARGE	Customer number	043	CT
Check tender	003	CHECK	PLU	048	PLU#
Credit	004	CREDIT	Price	049	PRC
New balance	006	NB	Menu shift	064	MENU
Table transfer	014	TBL TRANS	Open	067	OPEN
Received on account	020	RC	Subtotal	075	SUBTOTAL
Paid out	021	PD	Multiplication	082	X
Minus	027	-	New/Old check	093	NEW/OLD
Discount	028	%-	Media change	118	MEDIA CHG
Refund	033	RF	List number	137	LIST#
Error correct/Void	034	VOID	Cancel	236	CANCEL
Receipt	038	RCT			

Programming receipt/slip message procedure

Step 1. Press **MODE** and <PGM2> icon to turn “PGM-2”, select “2.Char & Message” and press **YES**.

Step 2. Select “1.Receipt/SLIP Msg” and press **YES**.

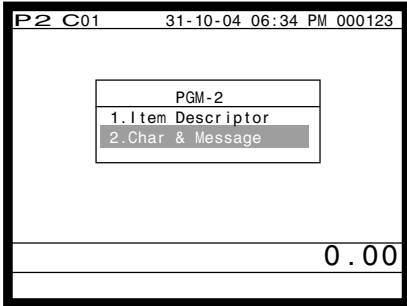

Step 1. screen

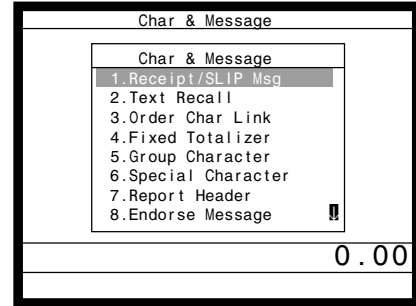

Step 2. screen

Step 3. Select the appropriate record, press **YES** and enter characters and press **ENTER**.

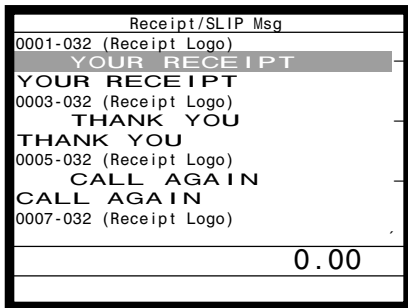

Step 3. screen

Select these upper (odd number) record

Select these upper (odd number) record

Select these upper (odd number) record

Rec No.	Message
1 ~ 8	Receipt logo message
9 ~ 16	Receipt commercial message
17 ~ 24	Receipt bottom message
25 ~ 32	Bill top message
33 ~ 40	Bill copy message
41 ~ 48	Bill bottom message
49 ~ 56	Slip logo message
57 ~ 64	Slip intermediate message
65 ~ 72	Slip bottom message
73 ~ 74	Post receipt (not used)
75 ~ 94	Guest bottom message
95 ~ 96	E-journal copy receipt message

Even records are not used.

Step 4. Repeat the step 3., if you have other records to program.

Step 5. Press **ESC/SKIP** repeatedly to return to the “Step 1. screen”.

Entering characters

In this section, the method to enter descriptors or messages (characters) to the terminal during programming is described. Characters are specified by character keyboard.

Entering characters

SHIFT1-case

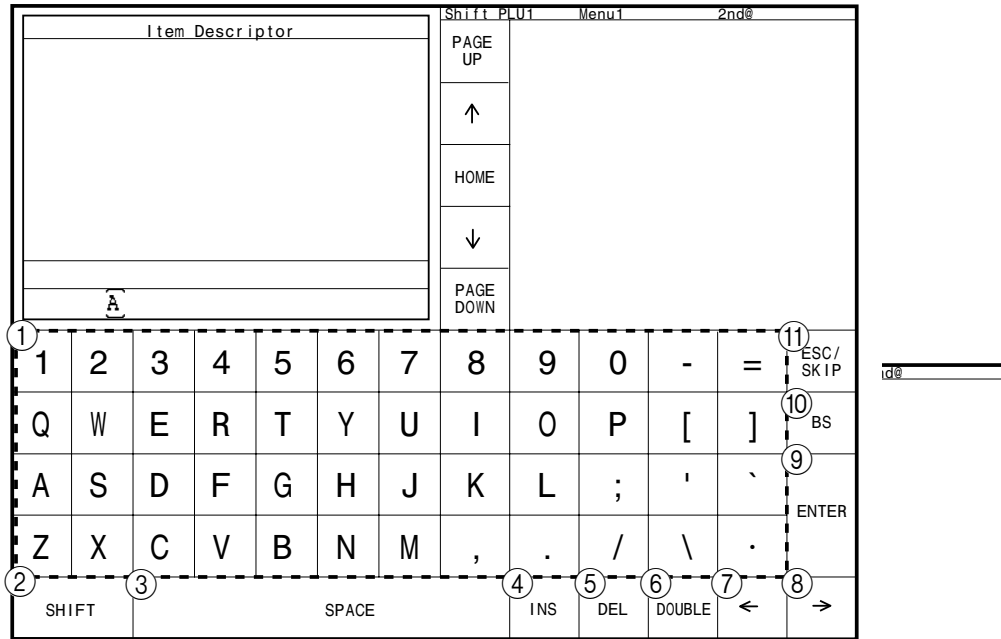

SHIFT2-case

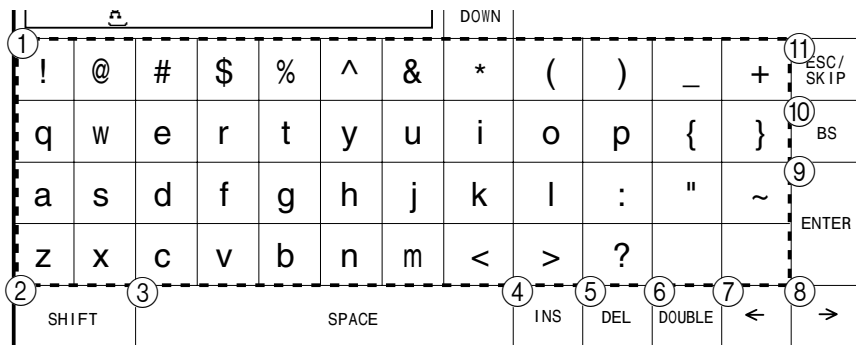

① Alphabet keys

Press these keys to input characters.

② Shift key

Press this key to shift the following characters from SHIFT1-case, SHIFT2-case, SHIFT3-case, SHIFT-4-case and returns to the SHIFT1-case letter in sequence.

③ Space key

Press this key to set a space.

④ Insert key

Press this key to put one space between the original characters.

⑤ Delete key

Press this key to clear the designated character.

⑥ Double size letter key

Press this key to specify that the next character you input to a double size character.

⑦ Left cursor key

Press this key to shift the character setting position to the left one by one. This key is used to correct already entered characters.

⑧ Right cursor key

Press this key to shift the character setting position to the right one by one. This key is used to correct already entered characters.

Example:

Input “ **A** p p l e J u i c e ”,
 enter DBL A SHIFT DBL p p l e SPACE SHIFT SHIFT SHIFT J SHIFT u i c e ENTER

SHIFT3-case

Item Descriptor										Shift PLU1	Menu1	2nd®	
										PAGE UP			
										↑			
										HOME			
										↓			
										PAGE DOWN			
A													
1	Â	Ô	Û	Î	Ê	Ç	Þ	Ø	£	×	f	¿	11
	Á	Ó	Ú	Í	É	Å	Ã		ä	ö		i	10
	À	Ò	Ù	Ì	È	Æ	Ý		ð	Ð	ß	±	9
	Ä	Ö	Ü	Ï	Ë	Ñ	Õ	«	»	€			ENTER
2	3		SPACE					4	5	6	7	8	
	SHIFT						INS	DEL	DOUBLE		←	→	

SHIFT4-case



A										DOWN			
1	â	ô	û	î	ê	ç	þ	ø					11
	á	ó	ú	í	é	å	ã	ÿ					10
	à	ò	ù	ì	è	æ	ý		¬	½	¼		9
	ä	ö	ü	ï	ë	ñ	õ	ç	α	'	-		ENTER
2	3		SPACE					4	5	6	7	8	
	SHIFT						INS	DEL	DOUBLE		←	→	

- ⑨ **Enter key**
 Press this key when the alphabetic entry for a descriptor, name or message has been completed. This key is also used for editing the programmed characters.
- ⑩ **Backspace key**
 Press this key to move the character placed behind.
- ⑪ **ESC/SKIP key**
 Press this key to terminate the character programming.



Advanced Operations





Editing characters





Correcting a character just entered

	OPERATION	DISPLAY
“L” “E” “N” “O” “N”	↵ Enter LENON, instead of LEMON.	LENON
  	↵ Press left arrow key three times.	LENON
“M”	↵ Enter “M”.	LEMON

Correcting and adding/deleting an item descriptor already set

	OPERATION	DISPLAY
Designate the item.		APPLE
 	↵ Press right arrow key two times.	APLE
	↵ Press <INS> (insert) key.	AP LE
“p”	↵ Enter “p”.	APPLE

	OPERATION	DISPLAY
Designate the item.		MOULSE
  	↵ Press right arrow key three times.	MOULSE
	↵ Press (delete) key.	MOUSE

	OPERATION	DISPLAY
Designate the item.		MOULE
  	↵ Press right arrow key three times.	MOULE
	↵ Press <BS> (backspace) key.	MOLE

Printing read/reset reports

• Read (X) report

You can display or print read reports at any time during the business day without affecting the data stored in the terminal.

• Reset (Z) report

After issuing a reset report, the totals stored in the terminal are reset. So, you should not print reset reports during the business day.

Important!

- The reset operation issues a report and also clears all sales data from the terminal's memory.
- Be sure to perform the reset operations at the end of each business day. Otherwise, you will not be able to distinguish between the sales data for different dates.

The tree of X/Z menu window

You can issue these kinds of report by tracing this tree.

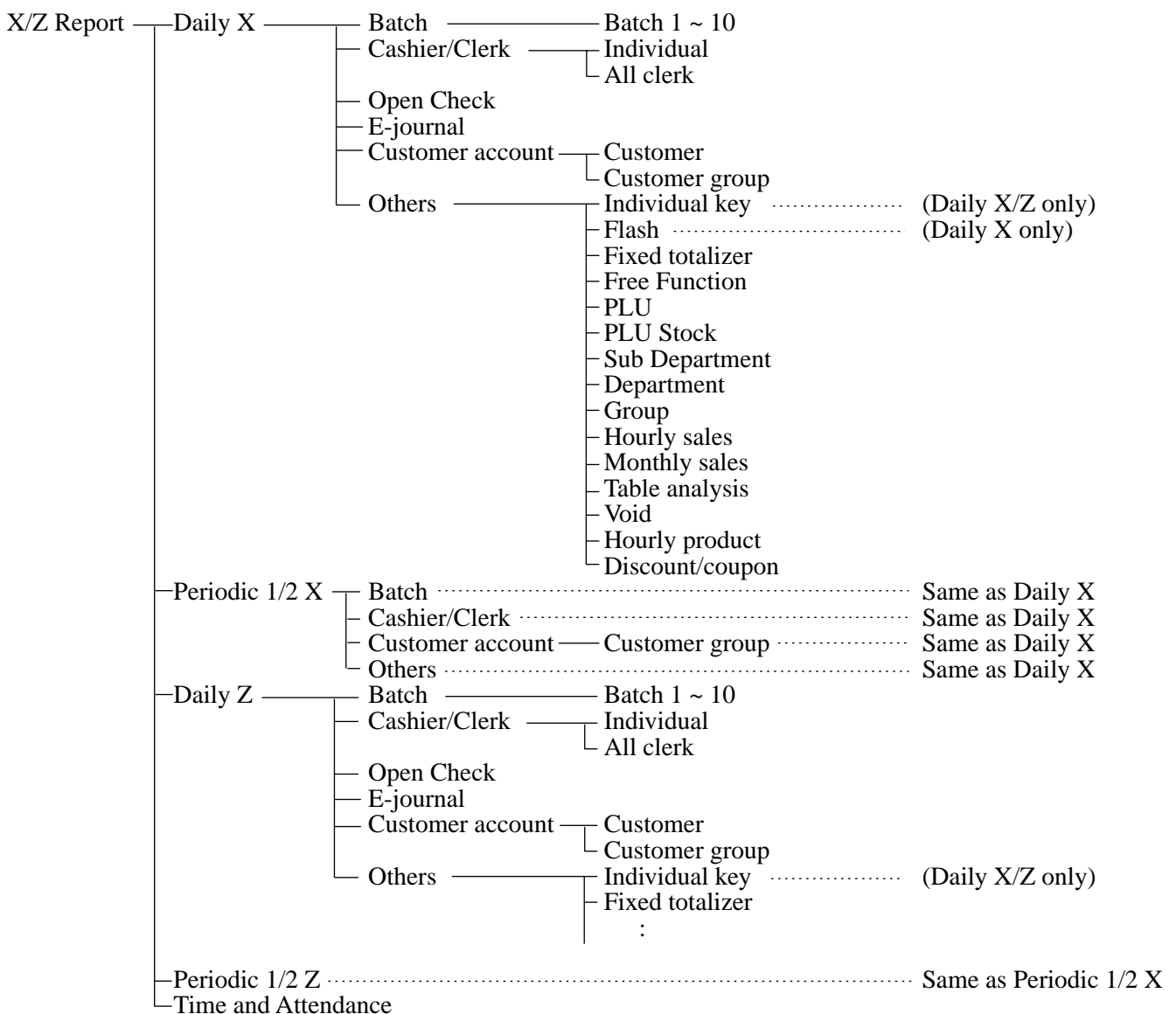

Advanced Operations

To print the individual key (department, subdepartment, PLU/flat-PLU, function) read report

This report shows sales for specific keys.

Procedure

Step 1. Press **MODE** and **<X/Z>** icon to turn "X/Z Report".

Step 2. Select "1.Daily X" and press **YES**.

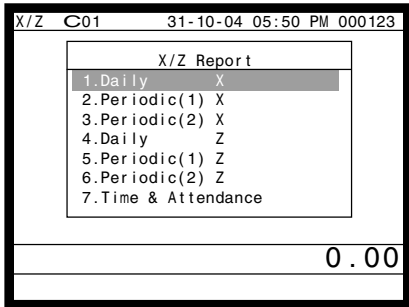

Step 1. screen

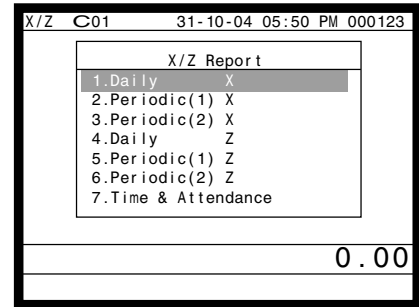

Step 2. screen

Step 3. Select "6.Others" and press **YES**.

Step 4. Select "1.Individual Key" and press **YES**.

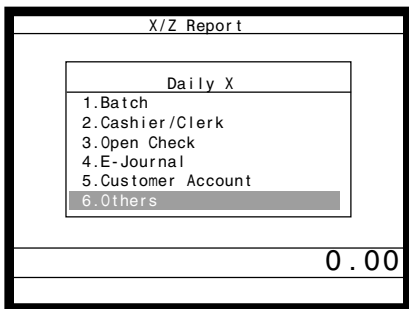

Step 3. screen

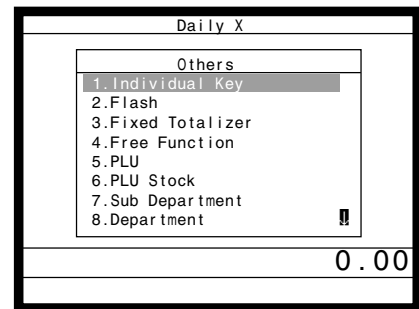

Step 4. screen

Step 5. Select keys you want to read. (The display shows totalizer/counter of the key.)

Step 6. After you finish to select keys, press **ESC/SKIP** to terminate this procedure – a report is issued.

Report (by optional remote printer)

X	0001095			Read symbol/Report code
PLU0001		17	.17.00	PLU name/No. of items/Amount
DISCOUNT			.2.50	Discount amount
#000001	0.53%			PLU code/Sales ratio
DEPT01		38	.257.53	Department name/No. of items/Amount
	8.13%			Sales ratio
DISCOUNT			.5.80	Discount amount
<hr/>				
CASH	No	11	.128.03	Key descriptor/Key count/Key total
%-	No	2	.10.29	
<hr/>				
TL		88	.516.10	Total No. of items/Total amount
DISCOUNT			.9.50	Discount amount total
	10.83%			Sales ratio

To print the financial read report

This report shows net sales, cash, charge, check and credit in drawer.

Procedure

Step 1. Press **MODE** and **<X/Z>** icon to turn “X/Z Report”.

Step 2. Select “1.Daily X” and press **YES**.

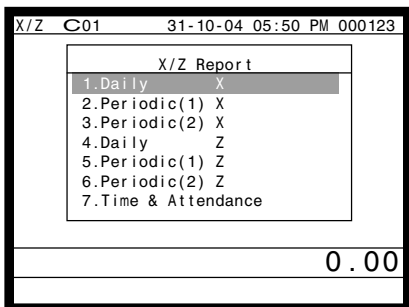

Step 1. screen

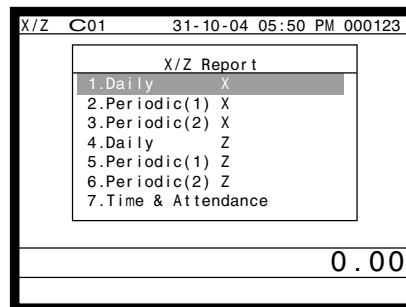

Step 2. screen

Step 3. Select “6.Others” and press **YES**.

Step 4. Select “2.Flash” and press **YES**. The declared drawer amount by **<#>** or **<#/NS>** should be entered before this step.

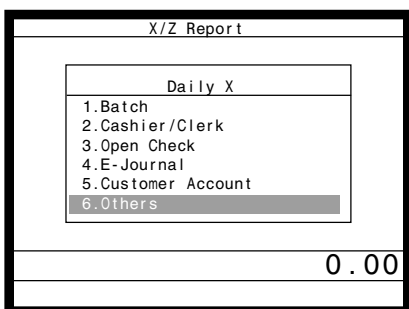

Step 3. screen

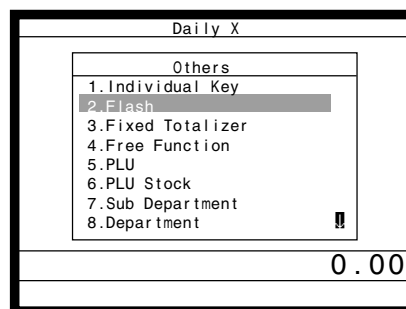

Step 4. screen

Step 5. Press **ESC/SKIP** repeatedly to return to the “Step 1. screen”.

Report (by optional remote printer)

X	0000071	FLASH		Read symbol/Report code/Report title
#			·6,919.04	Declared cash in drawer*1
			·0.00	Difference (= declared - accumulated) *1
NET	No	120	·7,263.20	No. of net sales/Net amount
CAID			·6,919.04	Cash in drawer
CHID			·178.60	Charge in drawer
CKID			·172.85	Check in drawer
CRID			·6.00	Credit in drawer

*1 Money declaration:

Count how much cash is in the drawer and input this amount (up to 10 digits).

The terminal will automatically compare the input with the cash in drawer in the memory and print the difference between these two amounts.

Note that if money declaration is required by programming, you cannot skip this procedure.

Advanced Operations

To print the individual clerk read/reset report

This report shows individual clerk totals.

Procedure

Step 1. Press **MODE** and **<X/Z>** icon to turn "X/Z Report", select "1.Daily X" or "4.Daily Z" and press **YES**.

Step 2. Select "2.Cashier/Clerk" and press **YES**.

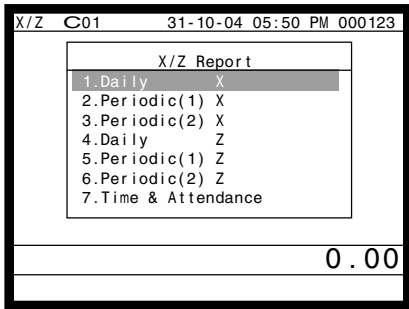

Step 1. screen

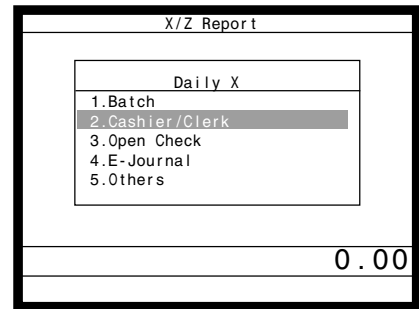

Step 2. screen

Step 3. Select "1.Individual" and press **YES**.

Step 4. Enter clerk No., press **YES** twice. The declared drawer amount by **<#>** or **<#/NS>** should be entered before this step.

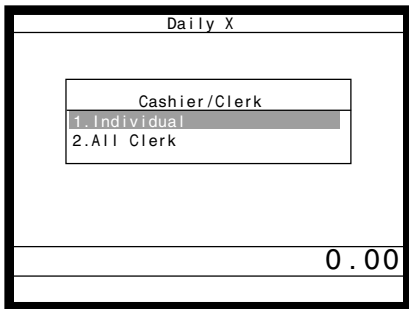

Step 3. screen

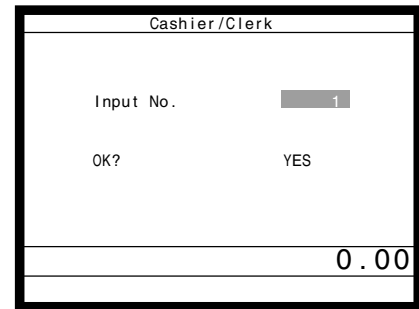

Step 4. screen

Step 5. Repeat the step 4., if you have other clerks to read.

Step 6. After you finish to select keys, press **ESC/SKIP** to terminate this procedure.

Report (by optional remote printer)

X	0020017	CASHIER/CLERK		Read symbol/Report code/Report title
#			-6,919.04	Declared cash in drawer of main currency *1
			.00	Difference (= declared - accumulated) *1
C01	1		Clerk name/drawer No.
GROSS		1485	-7,543.48	Gross total
NET	No	120	-7,263.20	Net total
CAID			-6,919.04	Cash in drawer
CHID			.178.60	Charge in drawer
CKID			-172.85	Check in drawer
CRID			-6.00	Credit in drawer

*1 Money declaration:

Count how much cash is in the drawer and input this amount (up to 10 digits).

The terminal will automatically compare the input with the cash in drawer in the memory and print the difference between these two amounts.

Note that if money declaration is required by programming, you cannot skip this procedure.

To print the daily sales read/reset report

Please refer to “Printing the daily sales reset report” section on page 42 of this manual.

To print the periodic 1/2 sales read/reset reports

These reports show breakdowns of sales by any two kinds of period you want.

Procedure

Step 1. Press **MODE** and **<X/Z>** icon to turn “X/Z Report”.

Step 2. Select “2.Periodic(1) X”, “3.Periodic(2) X”, “5.Periodic(1) Z” or “6.Periodic(2) Z” and press **YES**.

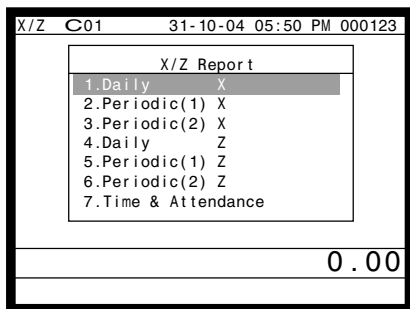

Step 1. screen

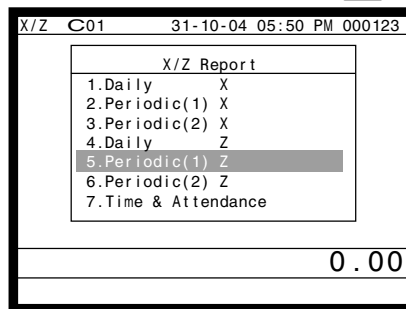

Step 2. screen

Step 3. Select “1.Batch” and press **YES**.

Step 4. Select “1.Batch(1)” and press **YES**.

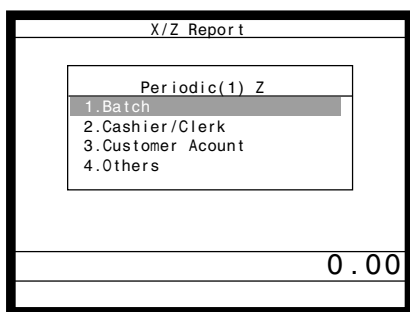

Step 3. screen

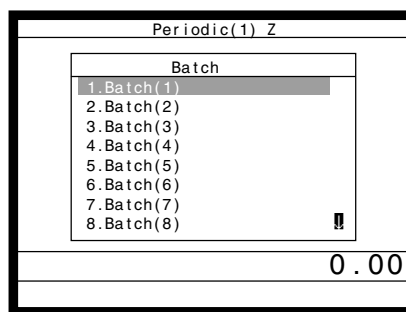

Step 4. screen

Step 5. Press **ESC/SKIP** repeatedly to return to the “Step 1. screen”.

Report (by optional remote printer)

ZZ1	0001011	FIXED TTL	1	Mode*/Report code/title /Reset counter
GROSS		981.250	-6,574.40	Gross total
NET	No	111	-7,057.14	Net total
CAID			-1,919.04	Cash in drawer
CKID			-859.85	Check in drawer
CRID			-709.85	
RF	No	3	-10.22	
DC			-1.22	
CLER			-2.40	
CLEAR	No	85	-0.00	
TX10			-0.00	
EX10	No	0	-0.00	
ZZ1	0001012	FREE FUNCTION	1	Mode*/Report code/title /Reset counter
CASH	No	362	-1,638.04	Function key count/amount
CHECK	No	56	-1,174.85	
RC	No	4	-810.00	
PD	No	5	-520.00	

ZZ1	0001015	DEPT	1	Mode*/Report code/title /Reset counter
DEPT01		203.25	-1,108.54	Department count/amount
DISCOUNT			-10.00	
DEPT02		183	-1,362.26	
DISCOUNT			-0.00	
DISCOUNT		5	-17.22	
DISCOUNT			-0.00	
TL		421.25	-2,872.28	Department total
DISCOUNT			-12.08	
ZZ1	0001017	CASHIER/CLERK	1	Mode*/Report code/title /Reset counter
C01				Clerk name/drawer No.
GROSS		421.254	-2,872.28	
NET	No	111	-1,845.35	
CAID			-1,057.14	
CRID			-0.19	
CKID			-9.02	

* Mode:
 XX1 = Periodic(1) X
 ZZ1 = Periodic(1) Z
 XX2 = Periodic(2) X
 ZZ2 = Periodic(2) Z

Advanced Operations

To print the PLU read/reset report

This report shows sales for PLUs.

Procedure

Step 1. Press **MODE** and **<X/Z>** icon to turn “X/Z Report”.

Step 2. Select “1.Daily X”, “2.Periodic(1) X”, “3.Periodic(2) X”, “4.Daily Z”, “5.Periodic(1) Z”, “6.Periodic(2) Z” and press **YES**.

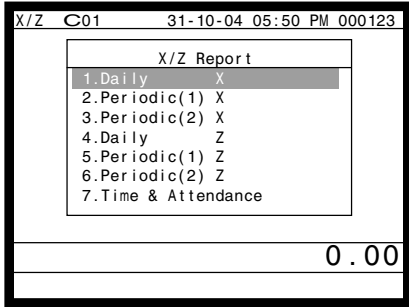

Step 1. screen

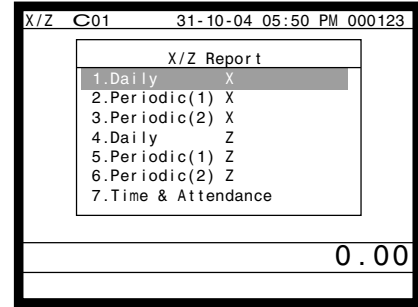

Step 2. screen

Step 3. Select “6.Others” and press **YES**.

Step 4. Select “5.PLU” and press **YES**, then select “1.All” and press **YES**.

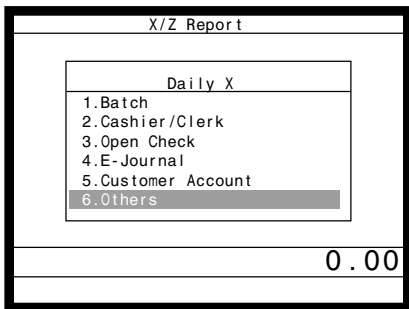

Step 3. screen

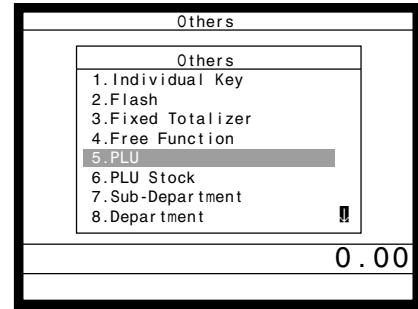

Step 4. screen

Step 5. Press **ESC/SKIP** repeatedly to return to the “Step 1. screen”.

Report (by optional remote printer)

X	000014	PLU		Read symbol/Report code/Report title
PLU0001	17		.17.00	PLU name/No. of items/PLU amount
DISCOUNT			.2.50	Discount amount
HOUSE BON QTY	2			House Bon quantity
#000001	0.53%			PLU code/sales ratio/
PLU0100	42		.69.00	
DISCOUNT			.0.50	
HOUSE BON QTY	0			
#000100	4.03%			
TL	188.61		.516.10	Total No. of items/Total amount
DISCOUNT			.9.50	Discount amount total
HOUSE BON QTY	17			House Bon quantity total
	17.92%			Sales ratio

To print the hourly sales read/reset report

This report shows hourly breakdowns of sales.

Procedure

Step 1. Press **MODE** and **<X/Z>** icon to turn “X/Z Report”.

Step 2. Select “1.Daily X”, “2.Periodic(1) X”, “3.Periodic(2) X”, “4.Daily Z”, “5.Periodic(1) Z”, “6.Periodic(2) Z” and press **YES**.

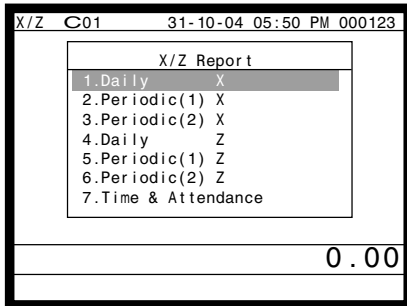

Step 1. screen

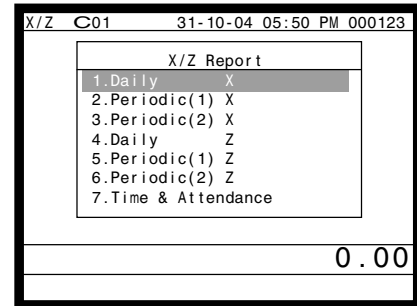

Step 2. screen

Step 3. Select “5.Others” and press **YES**.

Step 4. Select “10.Hourly Sales” and press **YES**.

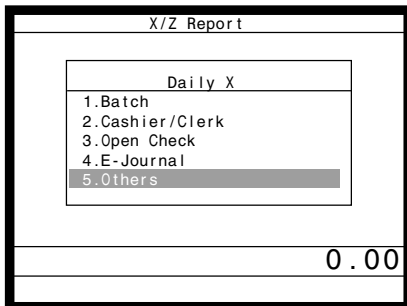

Step 3. screen

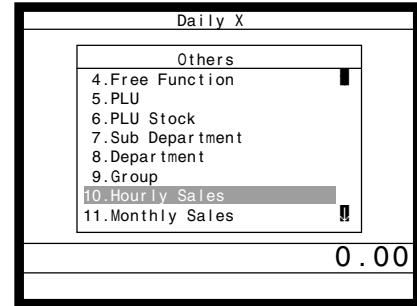

Step 4. screen

Step 5. Press **ESC/SKIP** repeatedly to return to the “Step 1. screen”.

Report (by optional remote printer)

X	0000019	HOURLY		
00:00->01:00		1		-1.20
1.90%	CT	1		-1.20
01:00->02:00		12		-12.00
19.00%				
23:00->00:00		1		-3.59
3.90%	CT	1		-3.59

— Read symbol/Report code/Report title

— Time range/no. of net sales/Net sales amount

— Sales ratio/No. of customers/Sum. of merchandise subtotal

Advanced Operations

To print the monthly sales read/reset report

This report shows monthly breakdowns of sales.

Procedure

Step 1. Press **MODE** and **<X/Z>** icon to turn “X/Z Report”.

Step 2. Select “1.Daily X”, “2.Periodic(1) X”, “3.Periodic(2) X”, “4.Daily Z”, “5.Periodic(1) Z”, “6.Periodic(2) Z” and press **YES**.

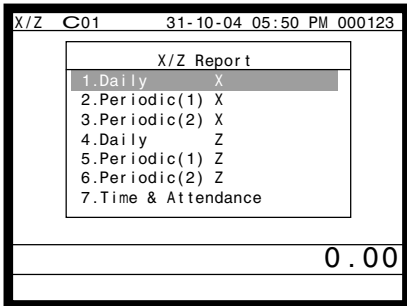

Step 1. screen

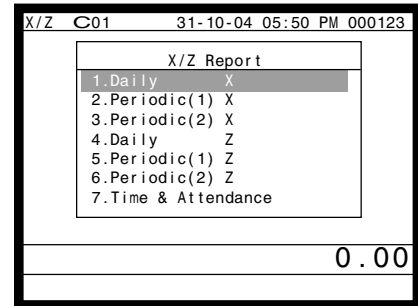

Step 2. screen

Step 3. Select “5.Others” and press **YES**.

Step 4. Select “11.Monthly Sales” and press **YES**.

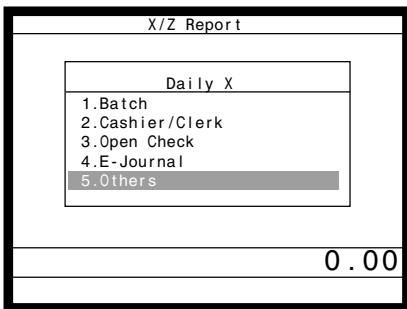

Step 3. screen

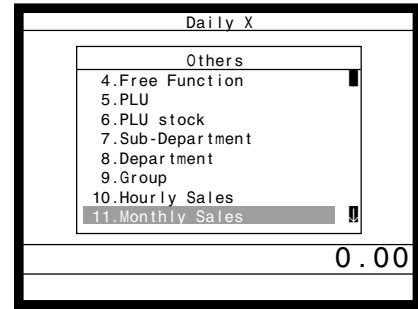

Step 4. screen

Step 5. Press **ESC/SKIP** repeatedly to return to the “Step 1. screen”.

Report (by optional remote printer)

X	000020	MONTHLY		Read symbol/Report code/Report title
1.....				Date of a month
GROSS		1236.76	·12,202.57	Gross symbol/No. of items/Gross sales amount
NET	No	214	·12,202.57	Net symbol/No. of net sales/Net sales amount
<hr/>				
31.....				Total symbol
GROSS		2132	·14,187.57	Gross symbol/No. of items/Gross sales amount
NET	No	205	·13,398.76	Average daily gross sales
<hr/>				
TL				Total symbol
GROSS		9746.63	·161,022.49	Gross symbol/No. of items/Gross sales amount
			·16.52	Average daily gross sales
NET	No	2351	·161,022.49	Net symbol/No. of net sales/Net sales amount
			·68.49	Average daily net sales

Reading the terminal's program

The tree of P6 (program read) menu window

You can issue these kinds of report by tracing this tree.

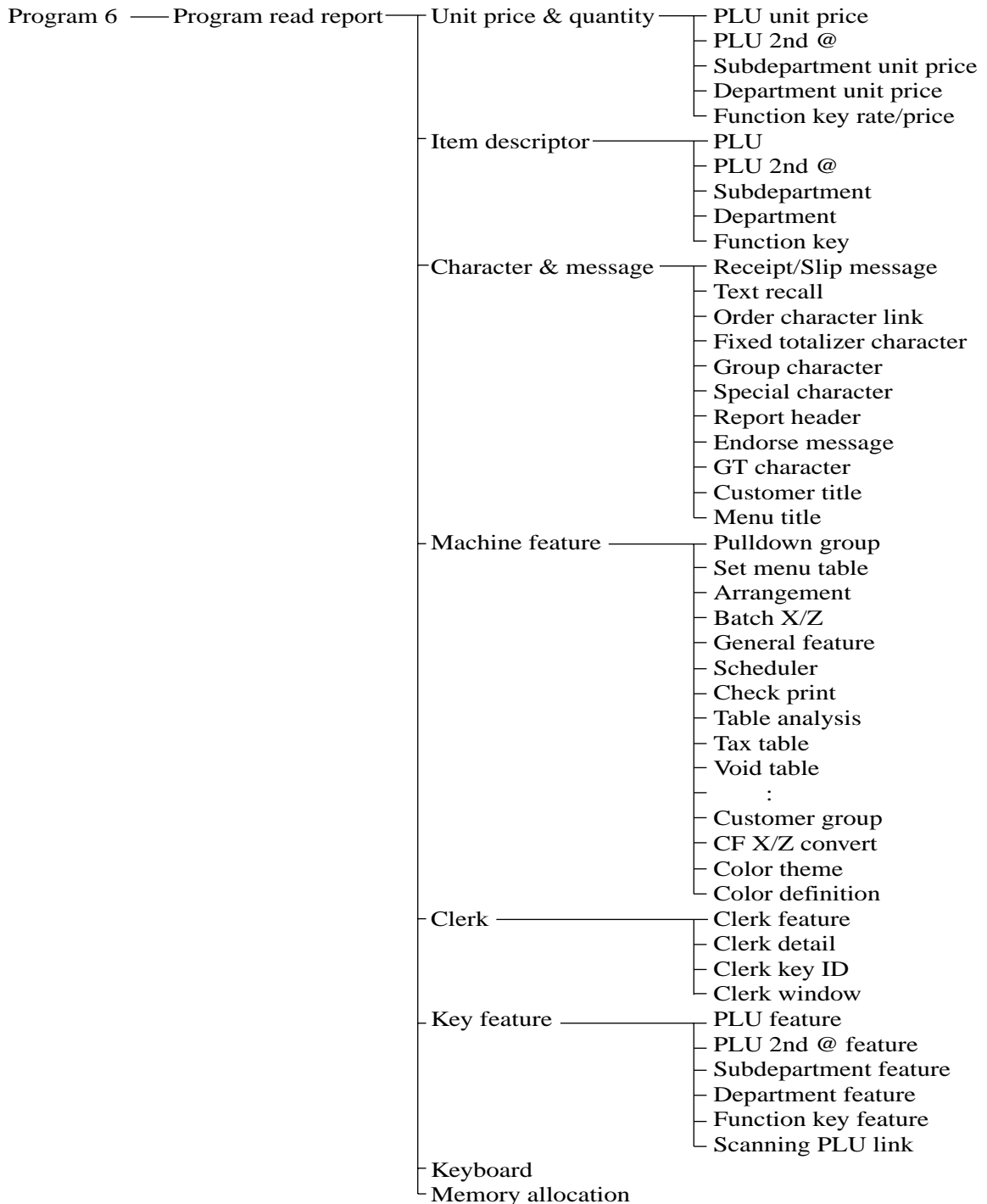

Advanced Operations

Procedure

Step 1. Press **MODE** and <PGM-6> icon to turn Program 6 mode and press **YES**.

Step 2. Select an appropriate job and press **YES**.

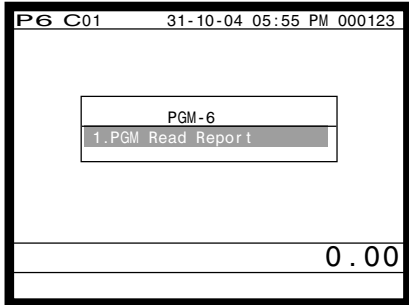

Step 1. screen

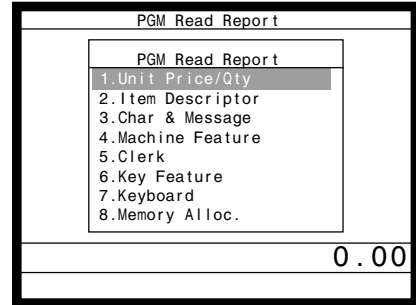

Step 2. screen

Step 3. Select an appropriate job and press **YES**. If the job requires range destination, Step 4 screen will appear.

Step 4. Enter the start/end range and press **YES**.

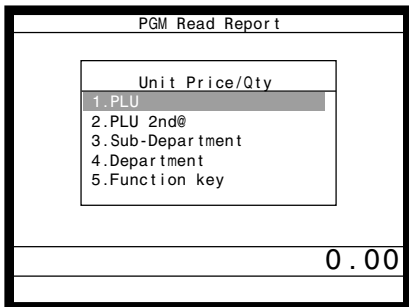

Step 3. screen

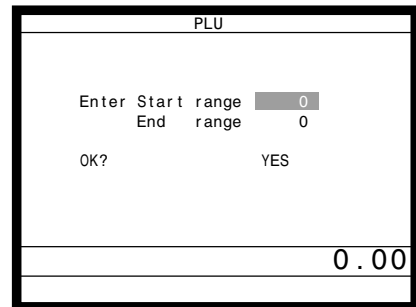

Step 4. screen

Step 5. Press **ESC/SKIP** repeatedly to return to the "Step 1. screen".

Report example (It is necessary to connect optional remote printer to print out these reports.)

Unit price and quantity

PLU unit price

PLU001	0001-004	PLU descriptor/Record No./File No.
	@12.34	Unit Price
	0001-055	Record No./File No.(Shift PLU)
	@2.00	Shift 2 PLU unit price
	:	
	@8.00	
PLU002	0002-004	
	@1.00	

PLU 2nd @

PLU001	2	0001-054	PLU 2nd descriptor/Record No./File No.
		@23.45	Unit quantity/2nd unit Price
PLU002		0002-054	
	1	@10.00	
PLU003		0003-054	
	0	@2.00	

Subdepartment unit price

SUBDEPT01	0001-003	Subdepartment descriptor/Record No./File No.
	@1.00	Unit Price
SUBDEPT02	0002-003	
	@2.00	
SUBDEPT03	0003-003	
	@3.34	

Department unit price

DEPT01	0001-005	Department descriptor/Record No./File No.
	@12.34	Unit Price
DEPT02	0002-005	
	@2.34	
DEPT03	0003-005	
	@1.34	

Function key rate/price

%-	0013-002	Function key descriptor/Record No./File No.
	0%	Unit Price, percent rate or conversion rate
-	0018-002	
	@0.00	
CASH	0035-002	
	@0.00	

Item descriptor

PLU

PLU001	0001-004	PLU descriptor/Record No./File No.
PLU002	0002-004	

PLU 2nd unit price

PLU001	0001-054	PLU 2nd descriptor/Record No./File No.
PLU002	0002-054	

Subdepartment

SUBDEPT01	0001-003	Subdepartment descriptor/Record No./File No.
SUBDEPT02	0002-003	
SUBDEPT03	0003-003	

Department descriptor

DEPT01	0001-005	Department descriptor/Record No./File No.
DEPT02	0002-005	
DEPT03	0003-005	

Function key descriptor

RCT	0001-002	Function key descriptor/Record No./File No.
NEW/OLD	0002-002	
RC	0003-002	
DISP ON/OFF	0004-002	
CLK#1	0005-002	

Advanced Operations

Character and Message

Receipt/Slip message

0001-032	YOUR RECEIPT	Record No./File No.
0002-032	THANK YOU	Receipt message
0003-032		

Clerk

Clerk feature

C01	001-007	Clerk name/Record No./File No.
	0001	Clerk secret code
	00	Drawer No.
	000111	
01-067	0000040000	Other program data
02-067	000000000000	
03-067	0000000000	
04-067	000000000000	
05-067	000000000000	
06-067	000000000000	
07-067	000000000000	
08-067	000000000000	
09-067	000000000000	
10-067	000000000000	
11-067	000000000000	
068	00000000	
069	000000000000	
C02	002-007	
	0002	

Key feature

PLU feature

PLU001	0001-004	PLU descriptor/Record No./File No.
	000000000000	Elementary program
11-066	000000	Other program data
12-066	000000	
13-066	0000	
14-066	0	
	0	
15-066	@0.00	
16-066	00	
17-066	00	
20-066	0000	
21-066	000000000000	
22-066	000000	
PLU002		

PLU 2nd unit price feature

PLU001	0001-054	PLU 2nd @ descriptor/Record No./File No.
	000000000000	Elementary program
11-066	000000	Other program data
12-066	000000	Other program data
14-066	0	Other program data
PLU002	0002-054	
	000000000000	
11-066	000000	
12-066	000000	
14-066	0	
PLU003	0003-054	

Subdepartment feature

SUBDEPT01	0001-003	Subdepartment descriptor/Record No./File No.
	000000000000	Elementary program
11-066	000000	Other program
15-066	@0.00	
16-066	00	
17-066	00	
20-066	0000	
21-066	00000000	
22-066	00	
SUBDEPT02	0002-003	

Department feature

DEPT01	0001-005	Department descriptor/Record No./File No.
	000000000000	Elementary program
11-066	000000	Other program
15-066	@0.00	
16-066	00	
17-066	00	
20-066	0000	
21-066	00000000	
22-066	00	
DEPT02	0002-005	

Function key feature

0001 CASH	000000000000	Record No./Key descriptor/Parameter
0002 CHARGE	000000000000	
0003 CREDIT	000000000000	
0004 %+	000000000000	
0005 CLEAR	000000000000	
0006 PGM MODE	000000000000	

Troubleshooting

This section describes what to do when you have problems with operation.

When an error occurs

Errors are indicated by an error codes. When this happens, you can usually find out what the problem is as illustrated below.

Press **C** and check the appropriate section of this manual for the operation you want to perform.

Prompt message	Meaning	Action
Operator mistake.	Operation error	Perform proper operation.
E001 Wrong mode.	Check tracking (Open mode error)	Return the mode to its original setting.
E003 Wrong operator.	Error clerk/Error clerk in check tracking	Input correct check number or assign the proper clerk.
E005 Insufficient memory.	Memory allocation over	Reallocate memory.
E011 Close the drawer.	Drawer compulsory	Close cash drawer.
E012 Journal paper end.	Journal paper end	Replace journal paper.
E014 Receipt paper end.	Receipt paper end	Replace receipt paper.
E015 Check R/J printer.	Internal R/J printer error	Check the internal R/J printer.
E016 Change back to REG mode.	Prohibit plural operation in REF/REG- mode	Switch to another mode and then back to the REF/REG- mode again.
E017 Enter Check/TBL number.	Check number compulsory	Input a check number.
E018 Enter Table number.	Table number compulsory	Input a table number.
E019 Enter Number of covers.	Cover compulsory	Enter the number of customers.
E020 Enter Seat number.	Seat number compulsory	Input a seat number.
E023 Stock running short.	Alarm when any item drops below its programmed minimum stock quantity during registration.	Perform stock maintenance.
E024 No stock is available.	Error when actual stock value for a registration items is a negative value.	Perform stock maintenance.
E028 Not found PLU or C/D is mismatch.	Scanning PLU is not found or OBR code is mismatched.	Re-enter the PLU code.
E029 No registration is possible while you are in the tender operation.	Attempted registration whilst partial tender operation is being done.	Finalize the transaction.
E031 Press ST key before Finalization.	ST compulsory	Press ST key.
E033 Enter tendered amount.	Amount tender compulsory	Enter tendered amount.
E035 Change amount exceeds the limit.	Change amount exceeds the limit.	Enter amount tendered again.
E036 Remove money from the drawer.	Contents of the drawer exceed the programmed limit — Sentinel function.	Perform pickup operation.
E037 Digit or Amount Limitation Over.	H.D.L., H.A.L., L.D.L. error	Enter correct unit price/amount.
E038 Perform Money Declaration	Money declaration compulsory	Perform money declaration.
E040 Issue Guest Receipt.	Guest receipt compulsory	Issue a guest receipt.
E041 Print Validation.	Validation compulsory	Perform validation operation.
E044 Print Cheque.	Check print compulsory	Perform check print operation.
E045 Print Check-Endorsement.	Check endorsement compulsory	Perform check endorsement operation.
E046 REG Buffer Full. Please Finalize or NB.	Registration buffer full	Finalize the transaction. Allocate sufficient buffer.
E047 Print bill.	Slip compulsory	Perform slip printing operation.
E048 Insert Slip Paper and retry.	Alarm when no paper is inserted in the Slip.	Insert new slip paper.
E049 CHECK memory full.	Check tracking index full/near end	Finalize and close the check number currently used.
E050 Detail memory full.	Check tracking memory full/near end	Finalize and close the check number currently used.
E051 CHK/TBL No. is occupied.	Attempt is made to use the <NEW CHECK> key to open a new check using a number that is already used for an existing check tracking memory.	Finalize and close the check that is currently under the number that you want to use or use a different check number.
E052 CHK/TBL No. is Busy.	Attempt to use the same check number whilst the specified number is being used in the other terminal.	Use another check number or close the check at that terminal.
E053 CHK/TBL No. is not opened.	Check number not found	Use the correct check number (if you want to reopen a check that already exists in the check tracking memory) or use <NEW CHECK> to open a new check.
E054 Out of CHK/TBL No. Range.	Check number range over	Enter correct number.
E056 Store range full.	All check number are occupied in range.	Recall the stored data.
E057 No item exists in detail.	Round repeat cannot be found in detail.	
E058 Enter post entry item.	Post entry item exists in detail.	Enter Post entry item.
E059 Press Eat-in or Take-out key.	Press eat-in or take-out key.	Press Eat-in or Takeout key.
*****	Printer offline. "*****" means ECR logical ID and printer number.	
E060 Printer offline.	Printer offline. "*****" means ECR logical ID and printer number.	
*****	Printer downed. "*****" means ECR logical ID and printer number.	
E061 Printer error.	Printer downed. "*****" means ECR logical ID and printer number.	The contents are printed on the backup printer.

Troubleshooting

Prompt message	Meaning	Action
***** E061 Printer error. YES:Retry to print. NO :Backup to R/J printer. ESC:Discard data.	Printer downed. "*****" means ECR logical ID and printer number.	Follow the prompt message.
***** E062 Printer paper end.	Paper near-end/end "*****" means ECR logical ID and printer number.	The contents are printed on the backup printer.
***** E062 Printer paper end. YES:Retry to print. NO :Backup to R/J printer. ESC:Discard data.	Paper near-end/end "*****" means ECR logical ID and printer number.	Follow the prompt message.
E064 Printer buffer full. YES:Retry to print. NO :Backup to R/J printer. ESC:Discard data.	Print buffer full at sender side	Follow the prompt message.
***** E070 Terminal out of action. Cannot print.	Down at target ECR which has printer "*****" means ECR logical ID and printer number.	
***** E071 Target terminal printer BF full. YES:Retry to print. NO :Backup to R/J printer. ESC:Discard data.	Printer buffer full at target ECR which has printer "*****" means ECR logical ID and printer number.	Follow the prompt message.
***** E072 Target printer terminal is busy.	Busy at target ECR which has printer "*****" means ECR logical ID and printer number.	
***** E073 Your receipt/order may not be issued. YES:Retry to print. NO :Backup to R/J printer. ESC:Discard data.	Time out at ECR which has printer "*****" means ECR logical ID and printer number.	Follow the prompt message.
E075 Negative Balance, cannot be finalized.	Attempted finalization when balance is less than zero.	Register item(s) until the balance becomes positive amount.
E080 Electronic Journal Full Please clear E-Journal.	Electronic journal full	Reset the electronic journal memory.
E082 ***** Illegal Data *****	Illegal Electronic journal data	
E083 Cannot create E-Journal. Check Flash memory.	Electronic journal file cannot be created.	Check flash memory.
***** E105 Check/TBL tracking Master down. Please call Manager!! YES:Retry for connection. NO :Remove it from system.	CHK master down "*****" means ECR logical ID.	Follow the prompt message.
***** E106 Check/TBL tracking Backup master down. Please call Manager!! YES:Retry for connection. NO :Remove it from system.	CHK BM down "*****" means ECR logical ID.	Follow the prompt message.
***** E107 Both Master&Backup master down. CHK/TBL tracking or Clerk interrupt is not available.	CHK M/BM down "*****" means ECR logical ID.	
***** E108 CHK/TBL Master is removed from system.	Master down then take it off from system "*****" means ECR logical ID.	
***** E109 CHK/TBL Backup master is removed from system.	Backup master down then take it off from system "*****" means ECR logical ID.	
E110 CHK data mismatch between Master and Backup master.	Data mismatch has occurred.	
E130 Middle of Pick up or Loan Press Cancel Key.	During picking up	Follow the prompt message.
E131 Middle of <Bill Copy> Press Cancel Key.	During bill copy	Follow the prompt message.
E133 Middle of <Media Change> Press Cancel Key.	During media change	Follow the prompt message.

Troubleshooting

Prompt message	Meaning	Action
E134 Middle of Clerk Transfer Press ESC Key.	During clerk transfer	Follow the prompt message.
E136 Middle of Separate Check Press ESC key.	During separate check	Follow the prompt message.
E139 Not allowed to be negative by Minus/Coupon key.	Credit balance error	Enter proper minus/coupon amount.
E140 Wrong menu.	This sheet holder is prohibited by program.	Set correct sheet holder.
E141 Press <TRAY TTL> twice before finalization.	<TRAY TOTAL> key is not pressed twice before finalization.	Follow the prompt message.
E145 Arrangement syntax error.	Arrangement syntax error	Program the arrangement again.
E150 Incorrect value entry.	Incorrect entry for PGM	Enter proper value again.
E151 Incorrect Key Pressed.	Linking is incorrect.	Enter proper key again.
E152 PGM File or Memory number does not Exist.	No such file, no such record	Enter file/record number again.
E164 Employee No. is not Found in the Employee File.	Employee No. is not set in the Employee File.	Enter employee number again.
E165 Employee No. is not Clocking-in.	Employee has not done CLOCK-IN operation yet.	Perform CLOCK-IN operation.
E166 Employee No. is Occupied.	Employee who has done CLOCK-IN operation attempts to operate CLOCK-IN again.	Enter the proper employee number again.
E167 Incorrect Job code.	Employee attempts to operate CLOCK-IN with incorrect JOB code.	Enter proper job code.
E168 Your Operation is out of Schedule. Please Call Manager.	Employees operate CLOCK-IN/OUT in not allowance time.	Follow the prompt message.
E169 Work Hours Exceeded. Please Call Manager.	Overtime work.	Follow the prompt message.
E170 No Shift Remains in the Schedule. You cannot Clock-in.	There is no available shift left.	
E171 Please Break-out and Retry.	Employee attempts to operate CLOCK-OUT whilst he/she is in a break time.	Follow the prompt message.
E172 Break Hours Exceeded. Please Call Manager.	Break hours are exceeded.	Follow the prompt message.
E173 This employee is at work now.	Employee is at work without break.	
E174 This employee is taking a break now.	Employee who has not done BREAK-OUT operation attempts to operate BREAK-IN.	
E175 Please Clock-in/Break-out before you sign on. or Please Call Manager.	Sign on after you clock-in or break out.	Follow the prompt message.
E176 You cannot Clock-in. Please reset Employee Report.	Employee Report has not been reset.	Follow the prompt message.
E177 Time&Attendance Data Communication Error. Please Call Manager.	Time & Attendance Data communication error.	Follow the prompt message.
E180 IDC FILE (1) memory full. Please clear IDC data.	IDC FILE (1) memory is full of items.	Follow the prompt message.
E181 IDC FILE (2) memory full. Please clear IDC data.	IDC FILE (2) memory is full of items.	Follow the prompt message.
E182 IDC FILE (3) memory full. Please clear IDC data.	IDC FILE (3) memory is full of items.	Follow the prompt message.
E200 Insert CF Card.	CF card is not inserted to the slot.	Insert CF card.
E201 Format error.	CF card data or formats illegal.	Check the CF card.
E203 Insufficient memory.	Insufficient memory is remained in CF card.	Format or use a new CF card.
E205 The file already exists. Do you replace? YES:Replace the file. NO :Input new name.	File name duplication error	Follow the prompt message.
E240 Customer No. is occupied.	Attempt is made to set a customer that already exists in the customer file.	Enter proper customer No.
E241 Customer memory full.	Customer file becomes full.	Delete unnecessary customer No.
E242 Customer not found.	This customer does not exist.	Enter proper customer No.
E243 Illegal Site ID.	The site No. of the file does not coincide with the No. of the card.	Swipe the proper magnetic card.
E244 Credit limit over.	Attempt to transfer when the balance is over than the credit limit	Release credit limit by OPEN2 Make minus, void, or refund operation to decrease the balance under the credit limit. Perform finalization or cancellation.
E251 Magnetic card error.	This card cannot be read. This card format is illegal.	Swipe the magnetic card again. Swipe the proper magnetic card.
E252 Enter customer name.		Follow the prompt message.
E253 Enter address.		Follow the prompt message.
E254 Enter phone number.		Follow the prompt message.

When the terminal does not operate at all

Perform the following check whenever the terminal enter an error condition as soon as you switch it on. The results of this check are required by service personnel, so be sure to perform this check before you contact a CASIO representative for servicing.

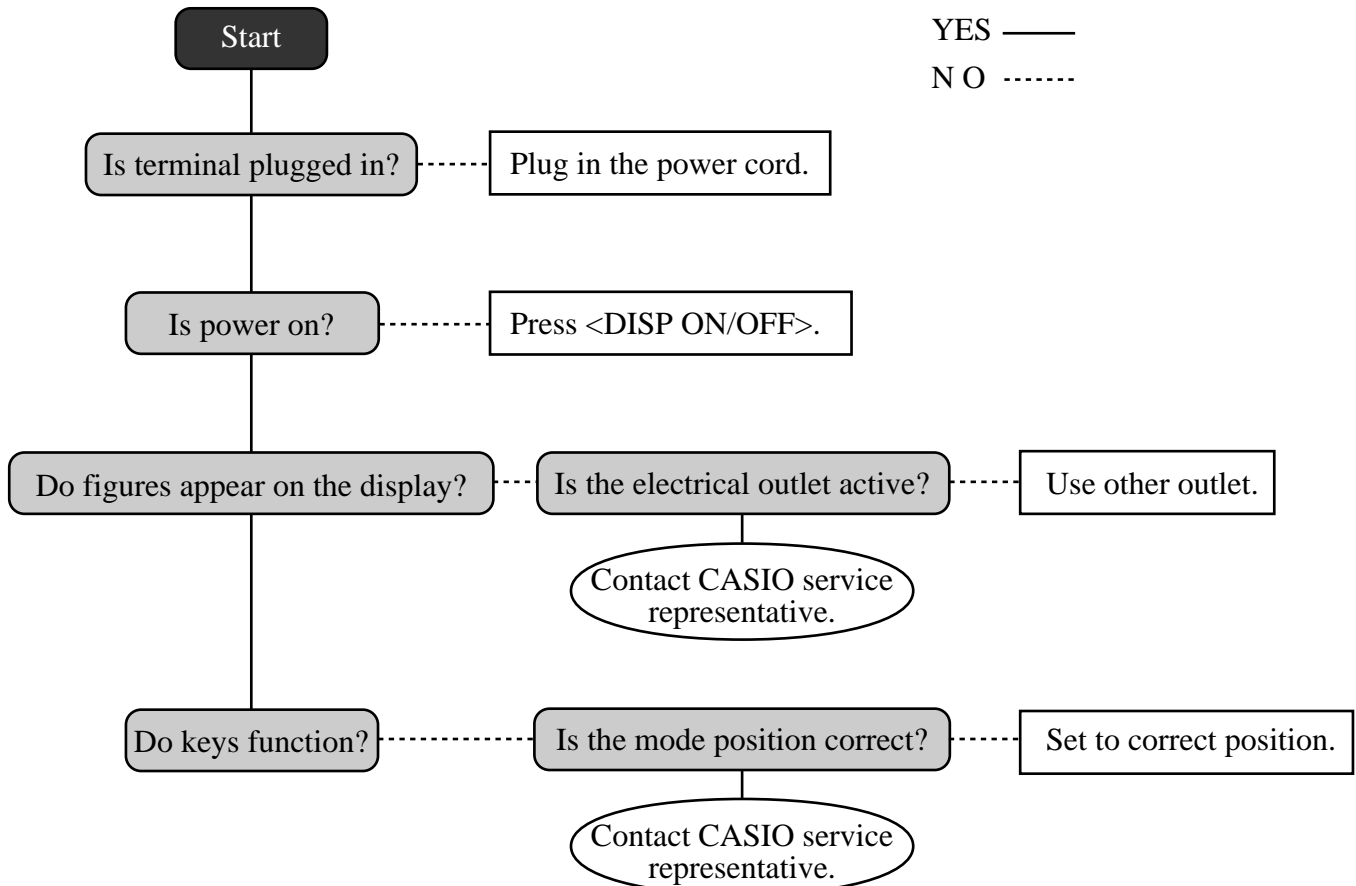

In case of power failure

If the power supply to the terminal is cut by a power failure or any other reason, simply wait for power to be restored. The details of any on-going transaction as well as all sales data in memory are protected by the memory backup batteries.

- Power failure during a registration
The subtotal for items registered up to the power failure is retained in memory. You will be able to continue with the registration when power is restored.
- Power failure during printing a read/reset report
- Power failure during printing of a receipt and the journal
Printing on remote printer will resume after power is restored. A line that was being printed when the power failure occurred is printed in full.

The memory protection battery is constantly charging and discharging as you switch the terminal on and off during normal operations. This causes the capacity of the battery to decrease after approximately five years of use.

Important !

- Remember a weak battery has the potential of losing valuable transaction data.
- A label on the back of the terminal shows the normal service period of the battery installed in the terminal.
- Have the battery replaced by your dealer within the period noted on this label.

Options

Remote customer display: QT-6060D
Hand held scanner: HHS-15
Slip printer: SP-1300
Cable: PRT-CB-8C
Power supply: AD31U or AD31E

Remote printer: UP-360, UP-250
Cable: PRT-CB-8A or PRT-CB-8B
Power supply: PS-180 and AC-170 for UP-250
Cash drawer:
MCR: QT-6046MCR
Interlink cable: PRL-CB-2

Consult with your CASIO dealer for details.

Specifications

Input method

Entry: 10-key system
 Function: Full key system

Display

Main: Color LCD: 12.1 inch 800 × 600 dots with touch screen

Listing capacity

Amount: 9999999
 Quantity: 9999,999
 Tended amount: 9999999999
 Percent: 99.99
 Tax rate: 9999.9999
 Numbers: 999999999999

Chronological data

Date print: Automatic date printout on receipt or journal, automatic calendar
 Time print: Automatic time printout on receipt or journal, 24-hour system/12-hour system

Alarm

Key catch tone, error alarm, sentinel alarm

Memory protection battery

24-hour full charge protects memories for approximately 30 days.
 Battery should be replaced every five years.

Power supply/power consumption

See the rating plate.

Operation temperature

0°C ~ 40°C (32°F ~ 104°F)

Humidity

20 ~ 85%

Dimensions and weight

311 mm (H) max. × 343 mm (W) × 327 mm (D) max. / 5.3 kg ...without drawer
 (12 1/4" (H) max. × 13 1/2" (W) × 12 7/8" (D) max. / 11 lbs. 10 oz)

Totalizers	Contents					
Category	No. of totalizers	Amount (10 digits)	No. of items (6 integer/3 decimal)	Count (4 digits)	No. of customers (6 digits)	Periodic totalizers
Department	Up to 99	✓	✓			✓
PLU	Up to 9999	✓	✓			✓
Clerk	Up to 99	✓	✓	✓	✓	✓
Hourly sales	24 ~ 96	✓		✓	✓	✓
Monthly sales	32	✓	✓	✓	✓	✓
Transaction	Variable with program					✓
Non resettable grand total	3	✓ (16 digits)				
Reset counter				✓		
Consecutive No.	1			✓ (6 digits)		

* Specifications and design are subject to change without notice.

A

AC adaptor 10
accessories 10
add check 19, 52
add-on new number type 18
adding to check 49
alphabet key 78
arrangement 19, 67
arrow key 16
assigning a clerk 23
auto new balance function 48

B

backspace key 79
batch printing 47
bill copy 19, 57
break-in/out key 19

C

cancel 41
cash in drawer 43
cash/amount tendered key 17
change 26
character editing 80
character entering 78
charge 19
check 19, 33
check endorsement 19
check in drawer 43
check number 15
check number method 48
check number pop-up window 18
check print 19
check tracking 15, 48
check/table number window 18
clear key 16
clerk 92
clerk interrupt 46
clerk key 16
clerk number 19
clerk number key 23
clerk programming 74
clerk sign off 23
clerk sign on 23
clerk transfer 19, 54
clock-in/out 19
closing check memory 50
condiment PLU 55
correct not registered item 39
correct previously registered item 41
correct registered item 40
correction 39
coupon 19, 63
coupon 2 19, 63
credit 19, 33
credit in drawer 43
cube 19
currency exchange 19, 68
cursor key 78

customer ID number 19

D

daily sales report 42, 85
date/time key 16
declaration 19
department 19
department descriptor 91
department number 19
deposit 19, 56
descriptor programming 75
discount 30, 31
discount total 43
display mode 19
display on/off key 10, 12
displaying the time and date 25
drawer 12
drawer lock 12
drawer open key 12
dust cover 10
Dutch account 19

E

eat-in 19
electronic journal display 19
error code 94
error correct key 16
ESC/SKIP key 16
escape 21
Euro 34

F

finalization list key 17
financial read report 83
first unit price 19
flat-PLU 26, 75
flat-PLU key 17
function key descriptor 76, 91
function list key 17

G

grand total 43
gross total 43
guest receipt 44, 50

H

hand held scanner 98
high amount limitation 29
home position key 17
hourly sales report 87
house Bon 19

I

i-Button key 12, 23
i-Button key receiver 10
individual clerk report 84
insert key 78
interlink cable 98

item descriptor 15
item quantity 15
item search 19

K

Ketten Bon 20
key descriptor 15
keyboard 16

L

list 20
list number 20, 56
list pop-up window 18
loan 20, 72
local currency 34
location change 20

M

magnetic card reader 98
media change 20, 72
menu level display 14
menu shift 17, 26
merchandise subtotal key 20
message programming 75
mixed tender 33
mode key 16
money declaration 84
monthly sales report 88
multiplication 27
multiplication key 16

N

net total 43
new balance 49
new balance key 17
new check 20, 48
new/old check 48
new/old check key 17
next 21
no key 17
no sale 16, 20, 41
non-add 20
non-add / no sale key 16
normal receipt 20
number of customer 15, 45
number of customer key 17

O

OBR (optical barcode reader) key 20
old check 48
old check key 20
open 20
open 2 20, 70
open check 20, 49
operator number 20, 54
operator X/Z 20
option 98
order character change 20

P

page up key 17
paid out 38
payment 20
pick up 20, 72
PLU 2nd descriptor 90
PLU descriptor 90
PLU number 20
PLU report 86
plus 20, 62
post entry 20
post receipt 17, 44
power failure 98
premium 20, 62
preparation PLU 55
preset amount tender 66
preset price 29
preset tax status 29
previous 21
price inquiry key 20
price key 20
printing slip 47
program reading 89

Q

quantity/for 20

R

read report 81
recall key 20
receipt/slip message programming 77
received on account 20, 38
reduction 30, 32
REF MODE 37
reference No. print 33
refund 20, 36
release HAL 70
release specific compulsion 70
remote customer display 98
remote printer 98
repeat 26
report title 43
reset counter 43
reset report 42, 81
round repeat 20

S

scanning PLU 73
seat number 20
second unit price 20, 64
selective item subtotal key 20
separate check 20, 53
separate check key 17
set menu 59
shift key 78
shift PLU 21
show table layout type 18
single item 61

Index

single item sale 26
slip 47
slip back feed/release key 21, 47
slip feed/release 21, 47
slip print 21
slip printer 98
space key 78
square key 21
stock (negative) 60
stock (under minimum level) 60
stock check 60
stock inquiry 21, 60
store 21
subdepartment 21
subdepartment descriptor 91
subdepartment number key 21
substitution 21
subtotal key 16

T

table number 15, 21, 49
table number method 48
table sharing 21
table transfer 54
table transfer key 17
takeout 21
tax amount 43
tax exempt 21
tax shift 21
tax status 15
taxable amount 43
taxable amount subtotal key 21
ten key pad 16
text print 21
text recall 21, 55
tilt the touch screen panel 11
tip 21
tips 59
touch screen panel 13
tray total 21, 58

U

unit price inquiry 73

V

validation 21
VAT 21
VAT breakdown 71
view 21
void key 16

X

X/Z menu window 81

Y

yes key 17

CASIO®

CASIO COMPUTER CO., LTD.
6-2, Hon-machi 1-chome
Shibuya-ku, Tokyo 151-8543, Japan

QT-6000*E

MO0407-A Printed in Malaysia

Printed on recycled paper