

ELECTRONIC CASH REGISTER

CE-T300

GROCERY

DAIRY

H. B. A.

FROZEN

FOOD



DELICATESSEN

Eu Di U.K.

USER'S MANUAL

CASIO[®]

Introduction & Contents

Introduction

Congratulations on your selection of a CASIO CE-T300 electronic cash register. This ECR is the product of the world's most advanced electronic technology, for outstanding versatility and reliability.

Simplified operation is made possible by a specially designed keyboard layout and a wide selection of automated, programmable functions.

A specially designed keyboard layout and a bright, easy-to-read display help to take the fatigue out of long hours operation.

The main plug on this equipment must be used to disconnect mains power. Please ensure that the socket outlet is installed near the equipment and shall be easily accessible.



Casio Electronics Co., Ltd.
Unit 6, 1000 North Circular Road
London NW2 7JD, U.K.

WARNING: This is a Class A product. In a domestic environment this product may cause radio interference in which case the user may be required to take adequate measures.

Please keep all information for future reference.

Important!

Your new cash register has been carefully tested before shipment to ensure proper operation. Safety devices eliminate worries about breakdowns resulting from operator errors or improper handling. In order to ensure years of trouble-free operation, however, the following points should be noted when handling the cash register.

Do not locate the cash register where it will be subjected to direct sunlight, high humidity, splashing with water or other liquids, or high temperature (such as near a heater).

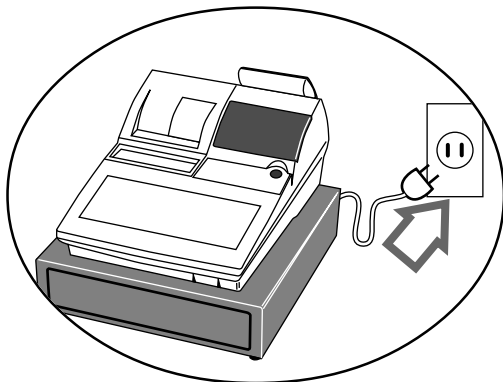
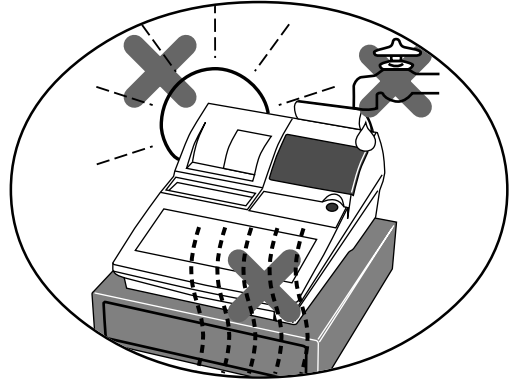

Be sure to check the sticker on the side of the cash register to make sure that its voltage matches that of the power supply in the area.

Never operate the cash register while your hands are wet.

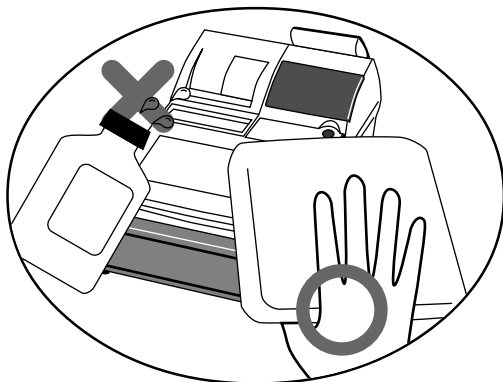
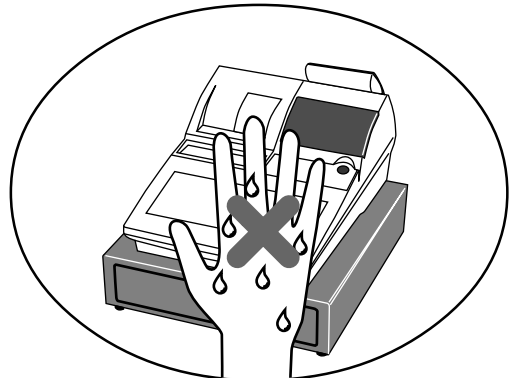

Use a soft, dry cloth to clean the exterior of the cash register. Never use benzene, thinner, or any other volatile agent.

Never try to open the cash register or attempt your own repairs. Take the cash register to your authorized CASIO dealer for repairs.

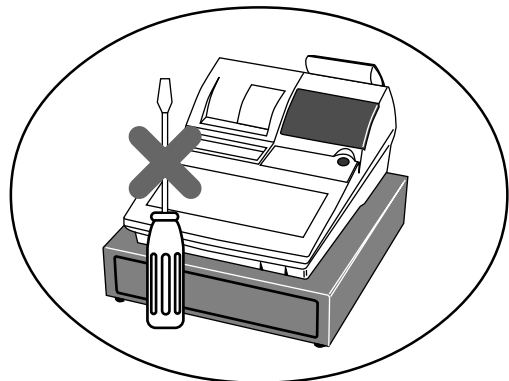

Introduction & Contents

Introduction & Contents	2
Getting Started	8
Remove the cash register from its box.	8
Remove the tape holding parts of the cash register in place.	8
Remove the cash drawer from its box.	8
Connect the drawer.	8
Mount the cash register.	9
Plug the cash register into a wall outlet.	9
Insert the mode key marked "OW" into the mode switch.	9
Install receipt/journal paper.	10
Set the date.	12
Set the time.	12
Tax table programming	13
Introducing CE-T300	16
General guide	16
Display	20
Keyboard	22
Basic Operations and Setups	24
How to read the printouts	24
How to use your cash register	25
Displaying the time and date	26
To display and clear the time	26
To display and clear the date	26
Preparing coins for change	26
Preparing and using department keys	27
Registering department keys	27
Programming department keys	28
To program a unit price for each department	28
To program the tax calculation status for each department	28
To program high amount limit for each department	29
Registering department keys by programming data	29
Preset price	29
Preset tax status	29
Locking out high amount limitation	30
Preparing and using PLUs	30
Programming PLUs	30
To program a unit price for each PLU	30
To program tax calculation status for each PLU	30
Registering PLUs	31
Printing VAT breakdowns	32
Preparing and using discounts	32
Programming discounts	32
Registering discounts	33
Discount for items and subtotals	33
Preparing and using reductions	33
Programming for reductions	33
Registering reductions	34

Registering credit and check payments	35
Check	35
Credit	35
Mixed tender (cash, credit and check)	35
Preparing and registering the Euro	36
Basic programming for the Euro and its exchange rate	36
Registering the Euro	36
Registering returned goods in the REG mode	38
Registering returned goods in the RF mode	38
Normal refund transaction	38
Reduction of amounts paid on refund	39
Registering money received on account	39
Registering money paid out	39
Registering loan amounts	40
Registering pick up amounts	40
Changing media in drawer	40
Making corrections in a registration	41
To correct an item you input but not yet registered	41
To correct an item you input and registered	42
To cancel all items in a transaction	43
No sale registration	43
Printing the daily sales reset report	44
Advanced Operations and Setups	46
Clerk interrupt function	46
Single item cash sales	47
Addition	48
Addition (plus)	48
Premium (%+)	48
Coupon transactions	49
Coupon registration using <COUPON> (coupon key)	49
Coupon registration using <COUPON2> (coupon 2 key)	49
Arrangement key registrations	50
Arrangement programming	50
Currency exchange function	51
Registering foreign currency	51
Full amount tender in foreign currency	51
Partial tender in a foreign currency	52
Currency exchange programming	53
Temporarily releasing compulsion	53
Programming to clerk	54
Programming clerk number	54
Programming trainee status	54
Programming commission rate	54

Introduction & Contents

Programming machine features	55
Programming to general control file	55
Programming department/PLU	62
Batch feature programming to department/PLU	62
Individual feature programming to department/PLU	64
Programming to transaction keys	65
<CASH>, <CHARGE>, <CHECK>	65
<CREDIT>	66
<RECEIVED ON ACCOUNT>, <PAID OUT>	66
<#/NO SALE>	67
<%+>, <%->	67
<+>, <->, <COUPON>	68
<ARRANGEMENT>	69
<CURRENCY EXCHANGE>	69
<POST RECEIPT>	70
<MULTIPLICATION>, <QUANTITY/FOR>, <SQUARE>, <CUBE>	70
Programming descriptors and messages	71
Programming clerk name and messages	71
Programming department/transaction key descriptor	76
Programming PLU descriptor	77
Entering characters	78
Using character keyboard	78
Entering characters by code	79
Character code list	79
Keyboard layout change	80
Configuration of the physical key layout	80
Programming procedure	80
The outline of functions	81
Printing read/reset reports	82
To print the individual department, PLU read report	82
To print the financial read report	83
To print the individual clerk read/reset report	83
To print the daily sales read/reset report	84
To print the PLU read/reset report	86
To print the hourly sales read/reset report	86
To print the monthly sales read/reset report	87
To print the group read/reset report	87
To print the periodic 1/2 sales read/reset reports	88
Reading the cash register's program	90
To print unit price/rate program (except PLU)	90
To print key descriptor, name, message program (except PLU)	91
To print the general control program, compulsory and key program	92
To print the keyboard layout program	93
To print the PLU program	93
Troubleshooting	94
When an error occurs	94
When the register does not operate at all	95
Clearing a machine lock up	96
In case of power failure	96

To replace journal paper	97
To replace receipt paper	98
Options	98
Specifications	99
Index	100

Getting Started

This section outlines how to unpack the cash register and get it ready to operate. You should read this part of the manual even if you have used a cash register before. The following is the basic set up procedure, along with page references where you should look for more details.

- 1. Remove the cash register from its box.**

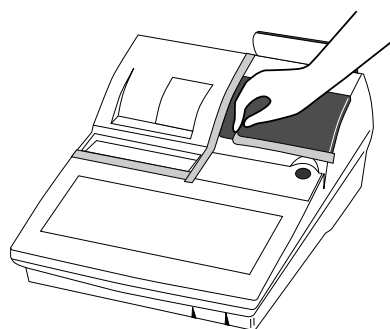
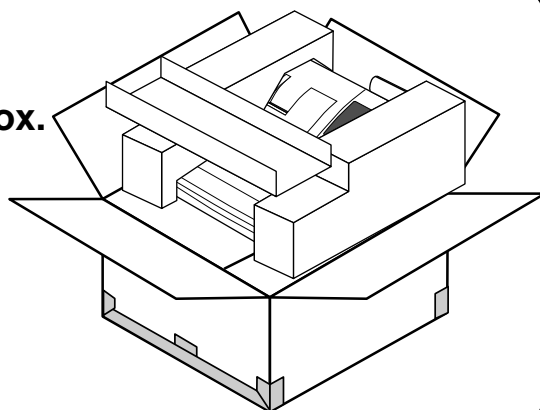

- 2. Remove the tape holding parts of the cash register in place.**

Also remove the small plastic bag taped to the printer cover. Inside you will find the mode keys.

- 3. Remove the cash drawer from its box.**
The cash register and cash drawer are packed separately.

- 4. Connect the drawer.**

1. Connect drawer connector (three color lead on drawer) to the cash register.
2. Connect frame drawer connector (green lead on drawer) to the cash register.

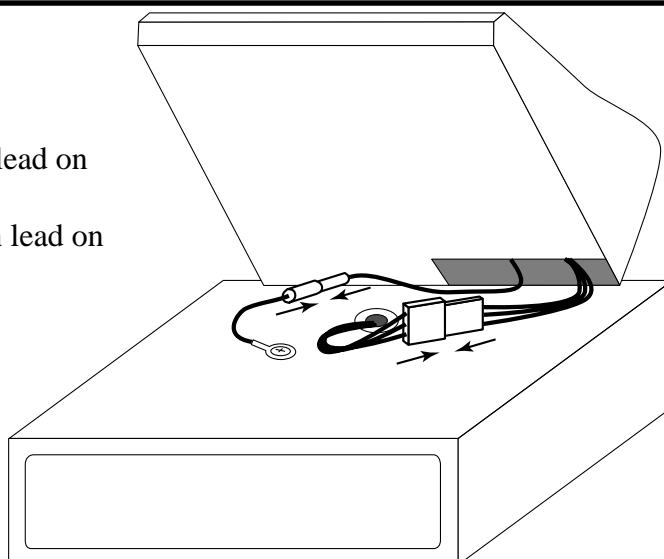

5. Mount the cash register.

1. Screw in 2 fixing screws bottom side of the register.
2. Stick rubber plate on the each corner of the bottom side of the register.
3. Mount the cash register on the top of the drawer, ensuring that the feet on the bottom of the cash register go into the holes on the drawer.

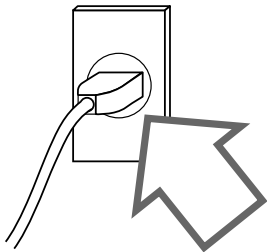
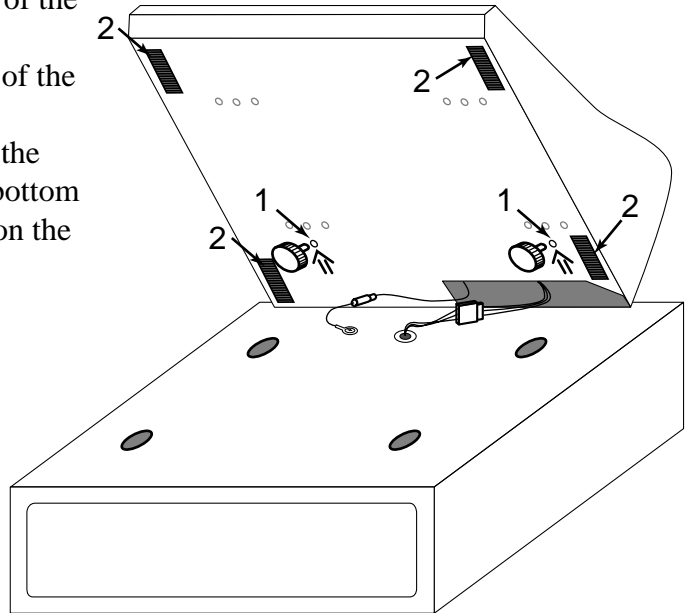

6. Plug the cash register into a wall outlet.

Be sure to check the sticker on the side of the cash register to make sure that its voltage matches that of the power supply in your area. The printer will operate for a few seconds. Please do not pass the power cable under the drawer.

7. Insert the mode key marked "OW" into the mode switch.

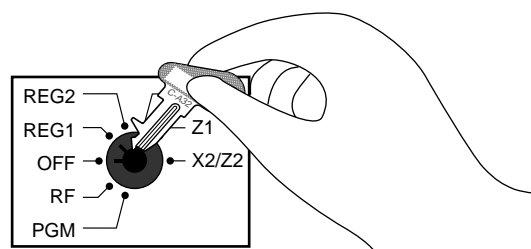

8. Install receipt/journal paper.

Loading journal paper

The same type of paper (58 mm × Max. 83 mm i.d.) is used for receipts and journal. Load the new paper before first operating the cash register or when red paper appears from the printer.

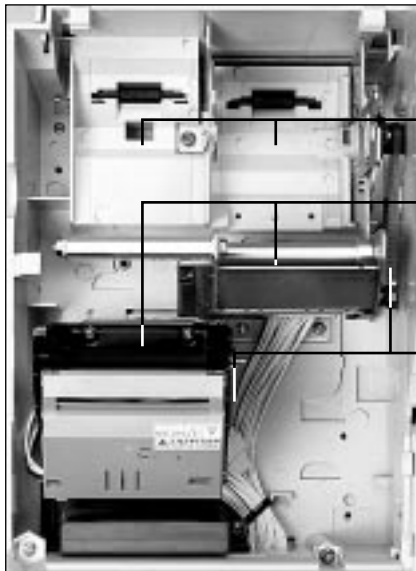

Paper holder

Paper inlet

Head release lever

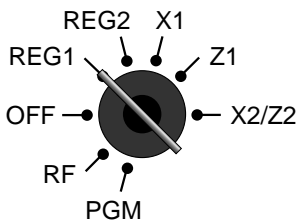

①

Use a mode key to set the mode switch to REG1 position.



④

Ensuring the paper is being fed from the bottom of the roll, lower the roll into the space behind the printer.



②

Open the printer cover.



⑤

Drop the paper roll gently and insert paper to the paper inlet. The paper is fed and loaded automatically.



③

Cut off the leading end of the paper so it is even.



⑥

Press the **JOURNAL FEED** key until about 20 cm to 30 cm of paper is fed from the printer.

Loading receipt paper

Follow steps ① through ③ under “Loading journal paper” on the previous page.



⑦

Slide the leading end of the paper into the groove on the spindle of the take-up reel and wind it onto the reel two or three turns.

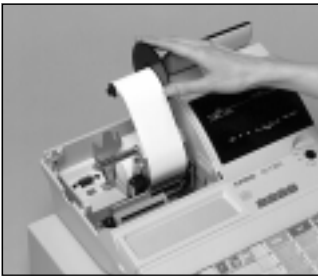

⑧

Place the take-up reel into place behind the printer, above the roll paper.



⑨

Press the **JOURNAL FEED** key to take up any slack in the paper.



⑩

Close the printer cover.



④

Ensuring the paper is being fed from the bottom of the roll, lower the roll into the space behind the printer.



⑤

Drop the paper roll gently and insert paper to the paper inlet.



⑥

The paper is fed and loaded automatically.

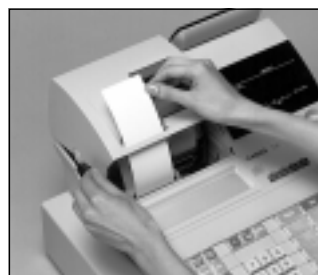

⑦

Set the printer cover.

Important!

The cash register cannot be operated without paper. First of all, paper loading is necessary.

Getting Started

9. Set the date.

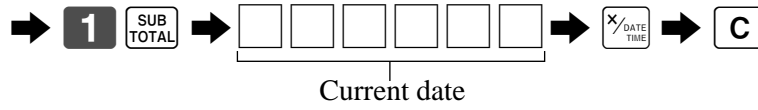
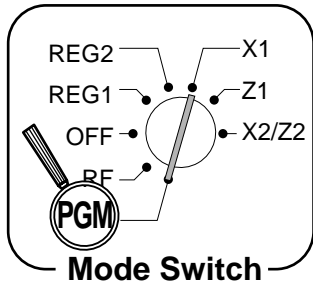

Example:

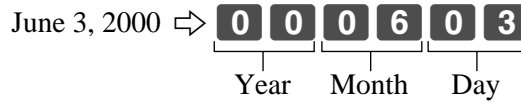

10. Set the time.

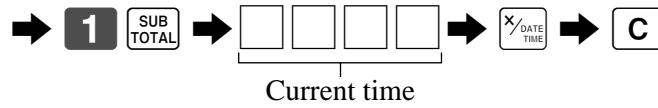
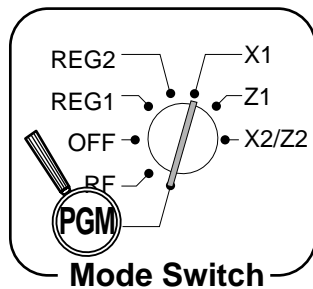

Example:

08:20 AM ⇒ [0][8][2][0]

09:45 PM ⇒ [2][1][4][5]

(24-hour military time)

11. Tax table programming

Programming automatic tax calculation

Important!

After you program the tax tables, you also have to individually specify which departments (page 28) and PLUs (page 30) are to be taxed.

Programming procedure

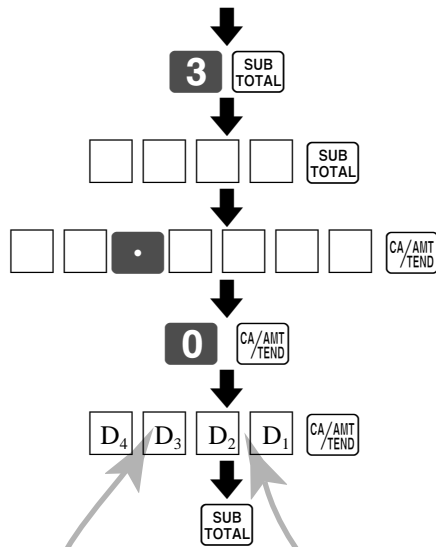
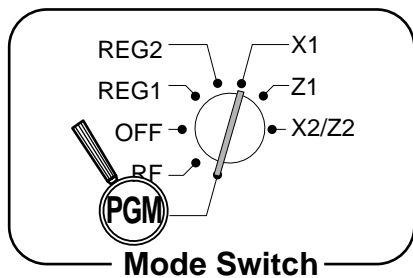

- Tax table 1 = 0 1 2 5
 - Tax table 2 = 0 2 2 5
 - Tax table 3 = 0 3 2 5
 - Tax table 4 = 0 4 2 5
- (for Singapore, tax table 1 ~ 3 can be used.)

Tax rate (4-digit for integer + 4-digit for decimal)

Tax table maximum value ("0" means unlimited).

Rounding/tax table system code ^{*1}

^{*1} Rounding/tax table system code

Rounding code specification

D ₄	D ₃	Rounding
5	0	Rounding off two decimal places
9	0	Rounding up to two decimal places
0	0	Cut off to two decimal places

Tax system code specification

D ₂	Rounding
4	Singapore rounding

Tax system code specification

D ₁	Rounding
2	Add-on tax rate
3	Add-in tax rate (VAT)
4	Tax on tax (Singapore tax)

Getting Started

Tax table programming (continued...)

Example 1, Add-on rate tax:

Programming procedure:

Tax rate (4-digit for integer + 4-digit for decimal) 8.25%
 Rounding/tax table system code 5002 (Round off)

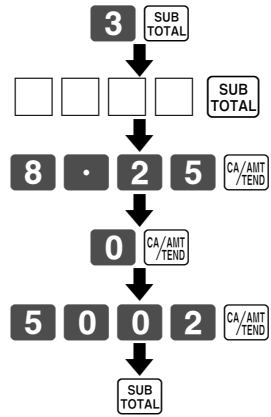
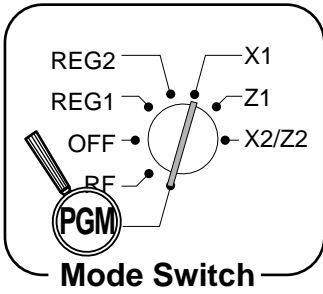

{ Tax table 1 = **0 1 2 5**
 Tax table 2 = **0 2 2 5** } (for Singapore,
 Tax table 3 = **0 3 2 5** } tax 1 ~ 3 can be used.)
 Tax table 4 = **0 4 2 5**

Tax rate (4-digit for integer + 4-digit for decimal)
 Always "0"
 Rounding/tax table system code

Example 2, Add-in rate tax:

Programming procedure:

Tax rate (4-digit for integer + 4-digit for decimal) 10.00%
 Rounding/tax table system code 0003 (Cut off)

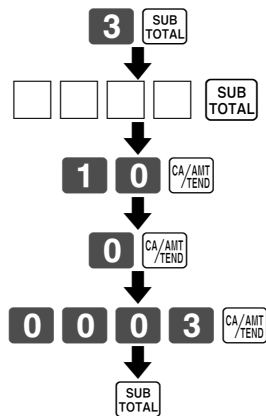
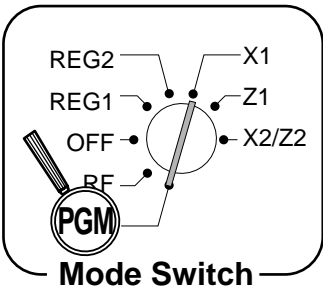

{ Tax table 1 = **0 1 2 5**
 Tax table 2 = **0 2 2 5** } (for Singapore, tax table 1 ~ 3
 Tax table 3 = **0 3 2 5** } can be used.)
 Tax table 4 = **0 4 2 5**

Tax rate (4-digit for integer + 4-digit for decimal)
 Always "0"
 Rounding/tax table system code

Tax table programming (continued...)

Example 3, Singapore tax:

Programming procedure:

Tax table 1	
Country tax	1%
Round off/tax on tax	5044
Tax table 2	
Service charge	10%
Round off/tax on tax	5044
Tax table 3	
GST	3%
Rounding off	5002

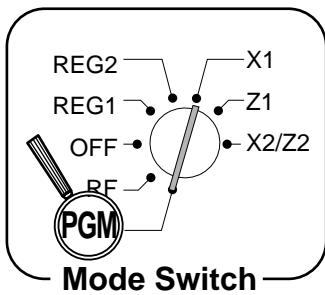

Tax table 1

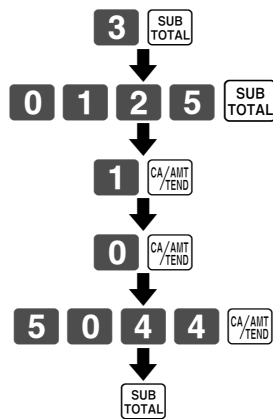

Tax rate (4-digit for integer + 4-digit for decimal)

Always "0"

Rounding/tax table system code

Tax table 2

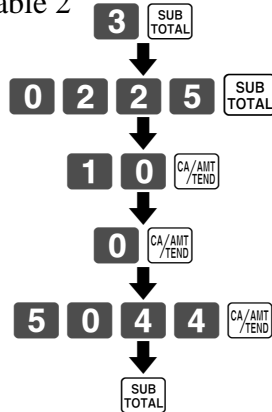

Tax table 3

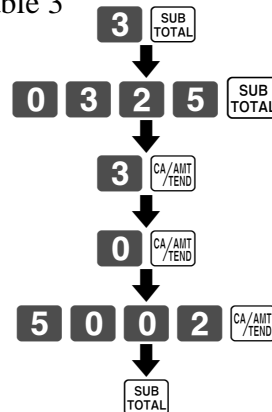

Introducing CE-T300

General guide

This part of the manual introduces you to the cash register and provides a general explanation of its various parts.

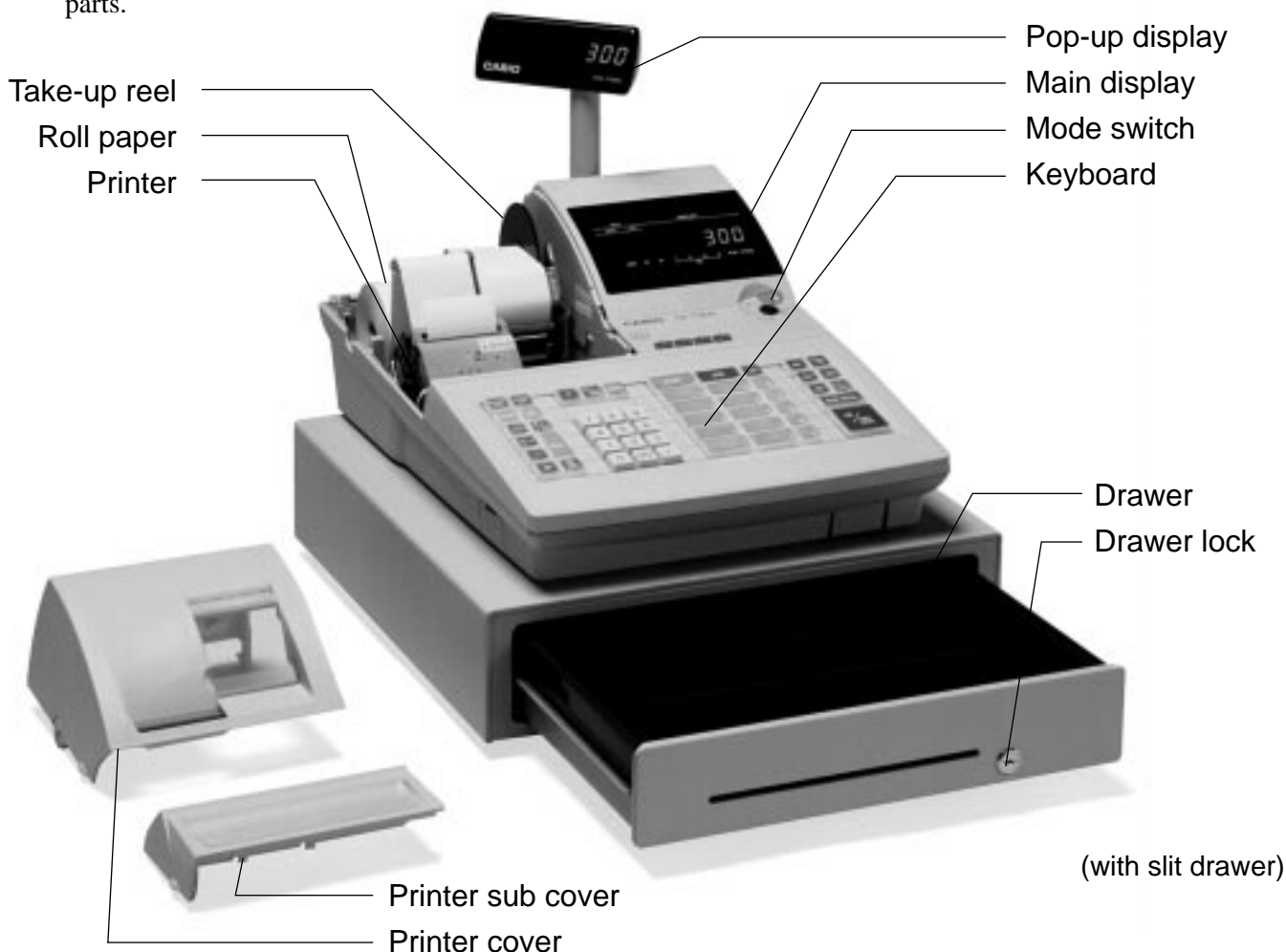

Roll paper

You can use the roll paper to print receipts and a journal (pages 10 ~ 11).

Receipt on/off switch / key

Use the receipt on/off switch/key in REG1, REG2 and RF modes to control issuance of receipts. In other modes, receipts or reports are printed regardless the receipt switch/key setting.

A post-finalization receipt can still be issued after finalization when the switch/key is set to off. The cash register can also be programmed to issue a post-finalization receipt even when the switch/key is set to on.

Receipt on/off switch

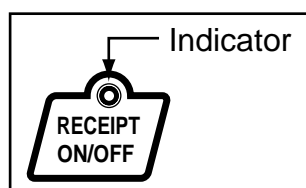

Receipt on/off key

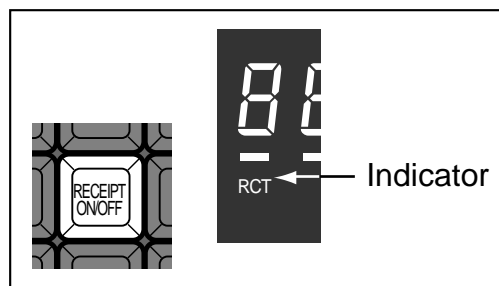

When the register issues receipts, this indicator is lit.

Mode key (only for U.K)

The following four types of mode keys are provided with the unit in the United Kingdom.

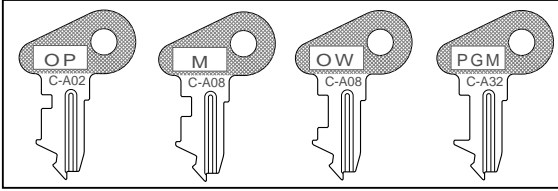

- a. OP (Operator) key
Switches between OFF and REG1.
- b. M (Master) key
Switches between OFF, REG1, REG2, X1 and RF.
- c. OW (Owner) key
Switches between OFF, REG1, REG2, X1, Z1, X2/Z2 and RF.
- d. PGM (Program) key
Switches to any position.

Mode key (for other area)

The following three types of mode keys are provided with the unit in areas outside of the United Kingdom.

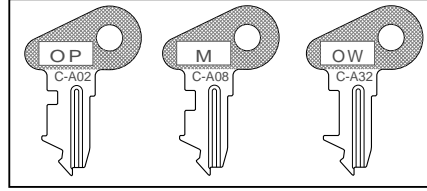

- a. OP (Operator) key
Switches between OFF and REG1.
- b. M (Master) key
Switches between OFF, REG1, REG2, X1 and RF.
- c. OW (Owner) key
Switches to any position.

Mode switch

Use the mode keys to change the position of the mode switch and select the mode you want to use.

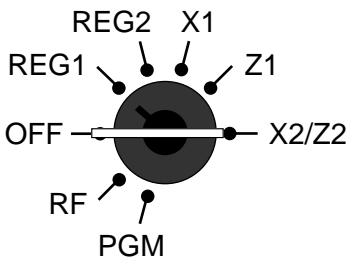

Mode switch	Mode name	Description
OFF	Stand-by	Any of the mode control keys can be inserted and removed from the mode switch in this position.
REG1	Register 1	Used for normal sales transactions. Any of the mode control keys can be inserted and removed from the mode switch in this position.
REG2	Register 2	Used for special operations. Since switching to REG2 requires a special key, such functions as discounts, credit sales, charge sales, check payments, and paid outs can be controlled by programming them as prohibited in REG1 and allowed in REG2.
RF	Refund Reg minus	Used for processing refunds. When the mode switch of the register is in RF position, you can access either the refund mode or the register minus mode.
X1	Daily sales read	Used to obtain daily reports without resetting (clearing) all total data.
Z1	Daily sales reset	Used to obtain daily reports while resetting (clearing) all total data.
X2/Z2	Periodic sale read/reset	Used to obtain periodic sales reports without resetting total data or while resetting all total data.
PGM	Program	Used when programming functions and preset data such as unit prices and tax rates. Also used when reading program data.

Introducing CE-T300

Clerk key/button/lock

In Germany, you can assign clerks by using clerk key or by clerk secret number (clerk key is equipped). In other areas, you can assign clerks by using clerk button or by clerk secret number. The method you are assigning clerk depends on the programming of your cash register.

Clerk secret number key

When the cash register is programmed to use clerk secret numbers for clerk or cashier assignment, the clerk buttons are not functional.

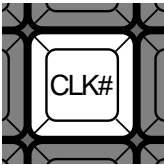

Clerk lock/key

You can assign the clerk or cashier inserting a clerk key into the clerk lock.

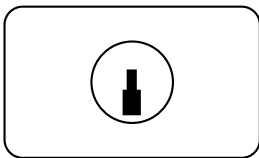

Clerk lock

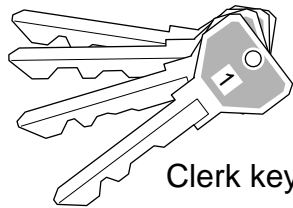

Clerk key

Clerk button

You can assign the clerk or cashier using the four buttons located below the display panel.



Drawer

The drawer opens automatically whenever you finalize a registration and whenever you issue a read or reset report. The drawer will not open if it is locked with the drawer key.

Drawer lock

Use the drawer key to lock and unlock the drawer.

When the cash drawer does not open!

In case of power failure or the machine is in malfunction, the cash drawer does not open automatically. Even in these cases, you can open the cash drawer by pulling drawer release lever (see below).

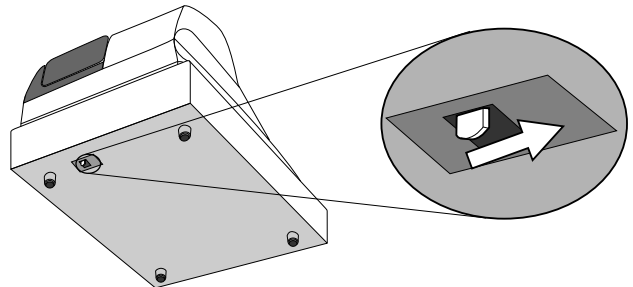

Important!

The drawer will not open, if it is locked with a drawer lock key.



Introducing CE-T300

Display

Main display except for Germany

Main display for Germany

Department registration

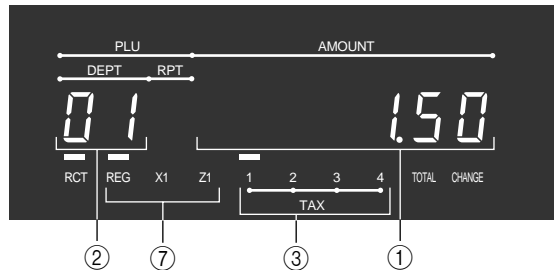
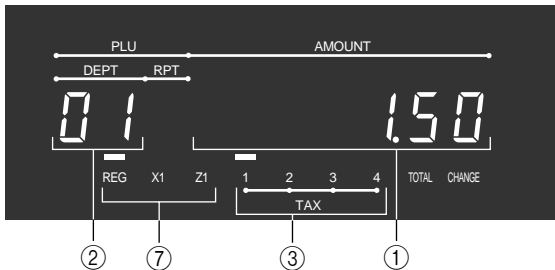

PLU registration

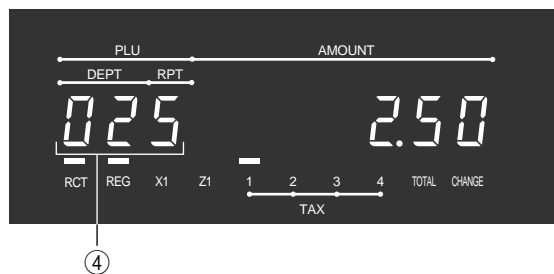
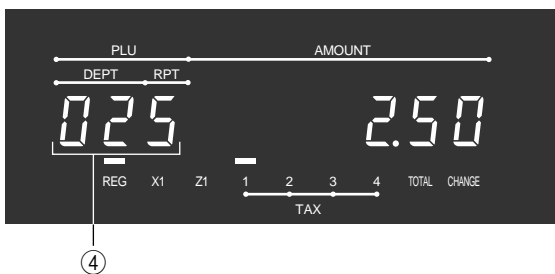

Repeat registration

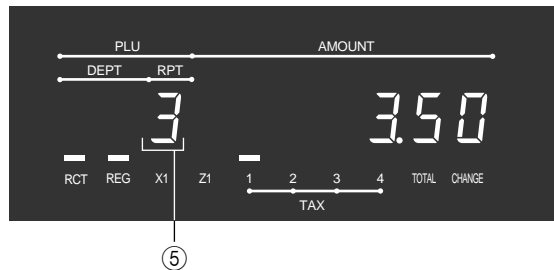
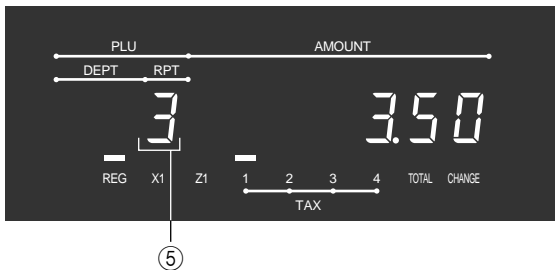

Totalize operation



Customer display for all area



① Amount/Quantity

This part of the display shows monetary amounts. It also can be used to show the current date and time.

② Department number

When you press a department key to register a unit price, the corresponding department number (01 ~ 15) appears here.

③ Taxable sales status indicators

When you register a taxable item, the corresponding indicator is lit.

④ PLU number

When you register a PLU item, the corresponding PLU number appears here.

⑤ Number of repeats

Anytime you perform a repeat registration (page 27), the number of repeats appears here. Note that only one digit is displayed for the number of repeats. This means that a "5" could mean 5, 15 or even 25 repeats.

⑥ Total/Change indicators

When the TOTAL indicator is lit, the displayed value is monetary total or subtotal amount. When the CHANGE indicator is lit, the displayed value is the change due.

⑦ REG, X1, Z1 indicators

REG: Indicates register mode

X1: Indicates daily sales read mode

Z1: Indicates daily sales reset mode

⑧ RCT indicator

When the register issues receipts, this indicator is lit.

Introducing CE-T300

Keyboard

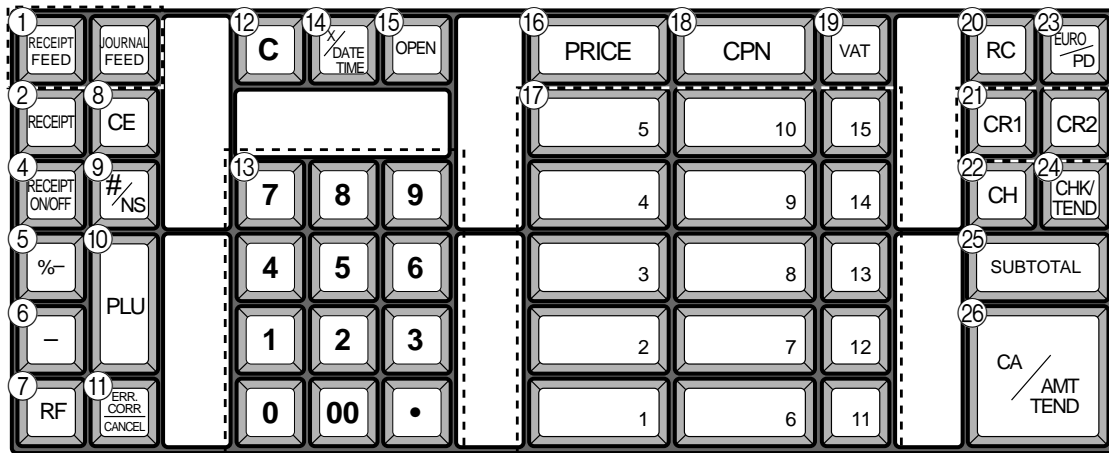

for German

• Register Mode

- ① **Paper feed key** RECEIPT FEED, JOURNAL FEED
Hold this key down to feed paper from the printer.
- ② **Post receipt key** RECEIPT
Use this key to produce a post-finalization receipt.
- ③ **Media change key** MEDIA CHANGE
This key is used to change media in drawer amounts. Pressing this key enters media change operation.
- ④ **Receipt on/off key** RECEIPT ON/OFF
Use this key pressing two times to change the status “receipt issue” or “no receipt.” In case of “receipt issue”, the indicator is lit.
- ⑤ **Discount key** %-
Use this key to register discounts.
- ⑥ **Minus key** -
Use this key to input values for subtraction.
- ⑦ **Refund key** RF
Use this key to input refund amounts and void certain entries.
- ⑧ **Currency exchange key** CE
Use this key to convert foreign currency to local currency or vice versa using the exchange rate preset for the key and displays the result.
- ⑨ **Non-add/No sale key** #/NS
Non-add key: To print reference number (to identify a personal check, credit card, etc.) during a transaction, use this key after some numerical entries.
No sale key: Use this key to open the drawer without registering anything.
- ⑩ **PLU key** PLU
Use this key to input PLU numbers.
- ⑪ **Error correction/Cancellation key** ERR CORR CANCEL
Use this key to correct registration errors and to cancel registration of entire transactions.
- ⑫ **Clear key** C
Use this key to clear an entry that has not yet been registered.
- ⑬ **Ten key pad** 0, 1 ~ 9, 00, .
Use these keys to input numbers.
- ⑭ **Multiplication/Date/Time key** x/DATE TIME
Use this key to input a quantity for a multiplication operation. Between transactions, this key displays the current time and date.

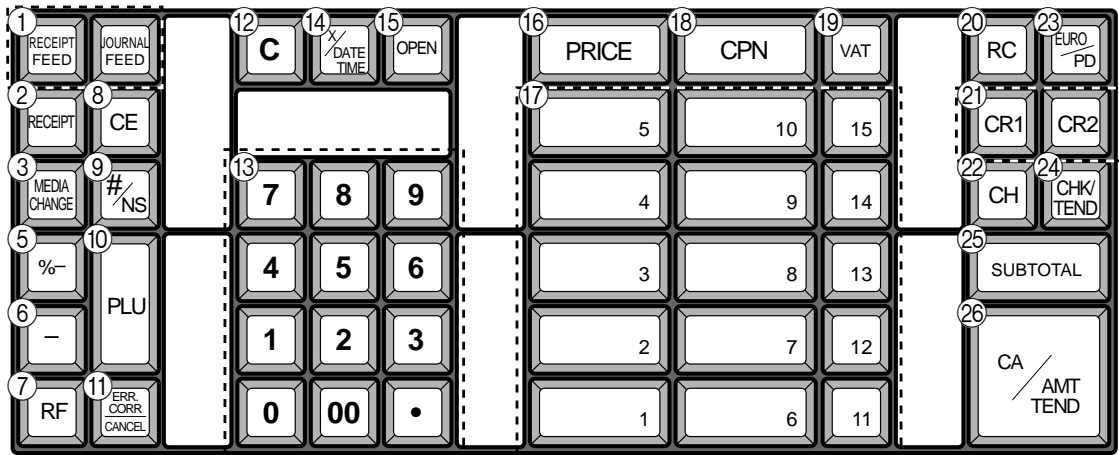

for other area

- ⑮ **Open key** OPEN

This key releases maximum amount limit or low digit limit for an amount which exceeds the limit.
- ⑯ **Price key** PRICE

Use this key to register an amount to an open PLU when a PLU is used as an open PLU.
- ⑰ **Department keys** 1, 2, 3 ~ 15

Use these keys to register items to departments.
- ⑱ **Coupon key** CPN

Use this key to register coupon. The registered coupon amount is deducted from the department, PLU, gross and net totalizers.
- ⑲ **VAT key** VAT

Use this key to print a VAT breakdown.
- ⑳ **Received on account key** RC

Press this key following a numeric entry to register money received for non-sale transactions.
- ㉑ **Credit key** CR1, CR2

Use this key to register a credit sale.
- ㉒ **Charge key** CH

Use this key to register a charge sale.
- ㉓ **Euro/Paid out key** EURO PD

Euro key: Use this key to convert the main currency to the sub currency (the euro/the local money), when registering a subtotal amount. This key is also used for specifying sub currency while entering an amount of payment or declaration in drawers.
Paid out key: Use this key following a numeric entry to register money paid out from the drawer.
- ㉔ **Check key** CHK/TEND

Use this key to register a check tender.
- ㉕ **Subtotal key** SUB TOTAL

Use this key to display and print the current subtotal (includes add-on tax) amount.
- ㉖ **Cash/Amount tendered key** CA/AMT TEND

Use this key to register a cash tender.

Basic Operations and Setups

How to read the printouts

- The journal and receipts are records of all transactions and operations.
- The contents printed on receipts and journal are almost identical.
- To save journal paper, you can choose the character height (standard/half) of journal (page 62).
- You can choose the journal skip function (page 57).

If the journal skip function is selected, the cash register will print the total amount of each transaction, and the details of premium, discount and reduction operations only, without printing department and PLU item registrations on the journal.

- The following items can be skipped on receipts and journal.
 - Consecutive number
 - Taxable status
 - Taxable amount
 - Item counter

Receipt Sample

```

*****
* THANK YOU *
**  CALL AGAIN  **
*****

* COMMERCIAL MESSAGE *
* COMMERCIAL MESSAGE *
* COMMERCIAL MESSAGE *
* COMMERCIAL MESSAGE *

REG 03-06-2000(SAT) 11:58
C01      MC#01      000123

1 DEPT01      T1      -1.00
1 DEPT02      T1      -2.00
5 DEPT03      -5.00

      7 No

TA1          -3.00
TX1          -0.15
TL          - 8.15
CASH        -10.00
CG          -1.85

*** BOTTOM MESSAGE ***
*** BOTTOM MESSAGE ***
*** BOTTOM MESSAGE ***
*** BOTTOM MESSAGE ***
    
```

Logo message/
Logo stamp image

Commercial message

Mode/Date/Time
Clerk/Machine No.
Consecutive No.

Q'ty/Item

Item counter

Bottom message

**Journal Sample
(Standard height character)**

```

REG 03-06-2000(SAT) 11:58
C01      MC#01      000123

1 DEPT01      T1      -1.00
1 DEPT02      T1      -2.00
5 DEPT03      -5.00

      7 No

TA1          -3.00
TX1          -0.15
TL          - 8.15
CASH        -10.00
CG          -1.85

REG 03-06-2000(SAT) 11:59
C01      MC#01      000124

1 DEPT01      T1      -1.00
1 DEPT12      T1      -1.00
5 DEPT03      -6.00

      7 No

TA1          -2.00
TX1          -0.10
TL          - 8.10
CASH        -10.00
CG          -1.90

REG 03-06-2000(SAT) 11:59
C01      MC#01      000124
    
```

**Journal Sample
(Half height character)**

```

REG 03-06-2000(SAT) 11:58
C01      MC#01      000123

1 DEPT01      T1      -1.00
1 DEPT02      T1      -2.00
5 DEPT03      -5.00

      7 No

TA1          -3.00
TX1          -0.15
TL          - 8.15
CASH        -10.00
CG          -1.85

REG 03-06-2000(SAT) 11:59
C01      MC#01      000124

1 DEPT01      T1      -1.00
1 DEPT12      T1      -1.00
5 DEPT03      -6.00

      7 No

TA1          -2.00
TX1          -0.10
TL          - 8.10
CASH        -10.00
CG          -1.90

REG 03-06-2000(SAT) 11:59
C01      MC#01      000125
    
```

In the operation examples contained in this manual, the print samples are what would be produced if the roll paper is being used for receipts. They are not actual size. Actual receipts are 58 mm wide. Also, all sample receipts and journals are printout images.

How to use your cash register

The following describes the general procedure you should use in order to get the most out of your cash register.

BEFORE business hours...

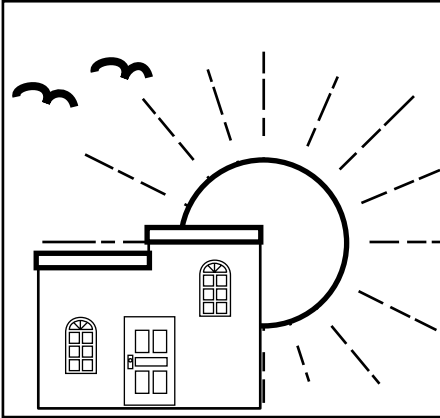

- Check to make sure that the cash register is plugged in securely. Page 9
- Check to make sure there is enough paper left on the roll. Pages 10, 11
- Read the financial totals to confirm that they are all zero. Page 83
- Check the date and time. Page 26

DURING business hours...

- Register transactions. Page 27
- Periodically read totals. Page 82

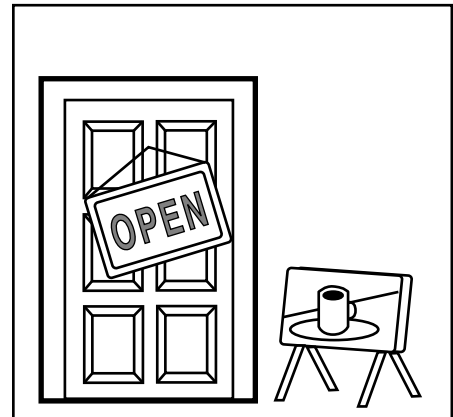

AFTER business hours...

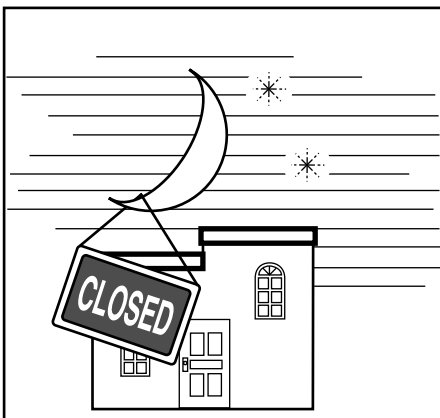

- Reset the daily totals. Page 44
- Remove the journal. Page 98
- Empty the cash drawer and leave it open. Page 18
- Take the cash and journal to the office.



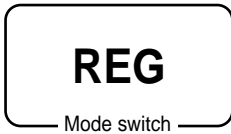

Basic Operations and Setups

Displaying the time and date







You can show the time or date on the display of the cash register whenever there is no registration being made.

To display and clear the time

OPERATION	DISPLAY
 Time appears on the display	 Hour Minutes
 Clears the time display	

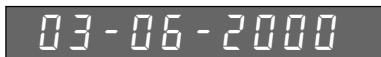
To display and clear the date

OPERATION	DISPLAY
 Time appears on the display	 (Time is displayed first)
 Date appears on the display	 Day Month Year
 Clears the date display	

Preparing coins for change



You can use the following procedure to open the drawer without registering an item. This operation must be performed out of a sale. (You can use the **RC** key instead of the **#/NS** key. See page 43.)

Opening the drawer without a sale

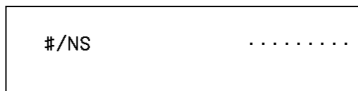
OPERATION	RECEIPT
	

Preparing and using department keys

Registering department keys

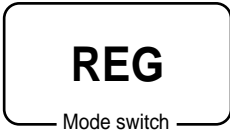

The following examples show how you can use the department keys in various types of registrations.

Single item sale

Example 1

Item	Unit price	\$1.00
	Quantity	1
	Dept.	1
Payment	Cash	\$1.00

OPERATION

1 00

Unit price

1

Department

CA/AMT
/TEND

RECEIPT

1 DEPT01	.1.00	Department No./ unit price
TL	- 1.00	Total amount
CASH	.1.00	

Example 2 (Subtotal registration and change computation)

Item	Unit price	\$12.34
	Quantity	1
	Dept.	1
Payment	Cash	\$20.00

OPERATION

1 2 3 4

Unit price

1

Department

**SUB
TOTAL**

2 0 00 CA/AMT
/TEND

Amount tendered

RECEIPT

1 DEPT01	.12.34	Total amount
TL	- 12.34	Amount tendered
CASH	.20.00	Change
CG	.7.66	

Repeat

Item	Unit price	\$1.50
	Quantity	3
	Dept.	1
Payment	Cash	\$10.00

OPERATION

1 5 0 1

1

1

**SUB
TOTAL**

1 0 00 CA/AMT
/TEND

RECEIPT

3 DEPT01	.4.50	Repeat items are gathered to one line.
TL	- 4.50	
CASH	.10.00	
CG	.5.50	

* Programmable option

Basic Operations and Setups

Multiplication

Item	Unit price	\$1.00
	Quantity	12
	Dept.	1
Payment	Cash	\$20.00

1 2 DATE TIME

Quantity
(4-digit integer/2-digit decimal)

1 00 1

2 0 00 CA/AMT/TEND

12 DEPT01	. 12.00	Quantity/result or *
DEPT01	@1/ 1.00	Quantity/unit q'ty/@
	. 12.00	Result
TL	- 12.00	
CASH	. 20.00	
CG	. 8.00	

* See address 0522 of the general function program.

Programming department keys

To program a unit price for each department

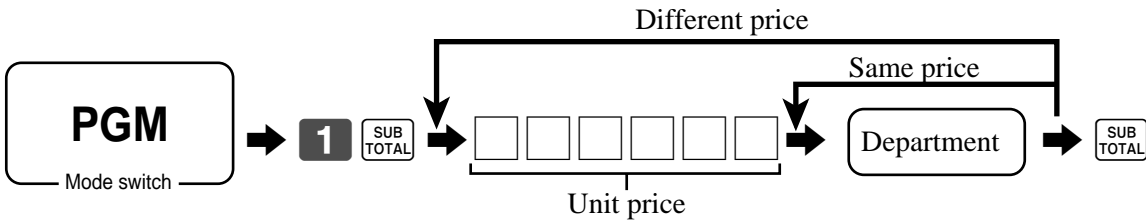

To program the tax calculation status for each department

Tax calculation status

This specification defines which tax table should be used for automatic tax calculation. See page 13 for information on setting up the tax tables.

Programming procedure

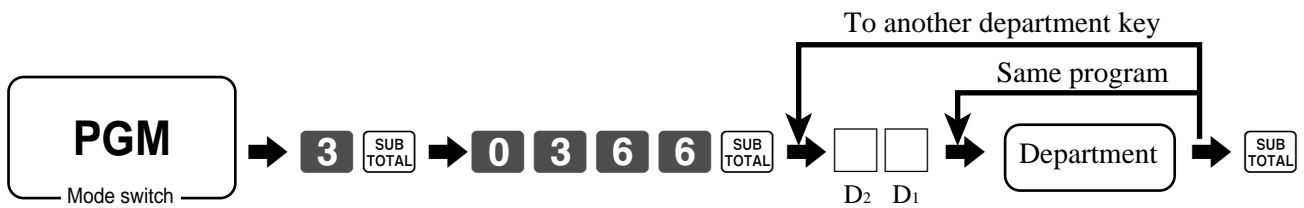

for Singapore				
Always "0"				<input type="checkbox"/> D ₂
Taxable 1 status	a	Yes = 1 No = 0	<input type="checkbox"/> (a+b+c) D ₁	
Taxable 2 status	b	Yes = 2 No = 0		
Taxable 3 status	c	Yes = 4 No = 0		
for other area				
Non tax = 0	Taxable 4 = 4	Taxable 8 = 8	Significant numbers	<input type="checkbox"/> D ₂ D ₁
Taxable 1 = 1	Taxable 5 = 5	Taxable 9 = 9		
Taxable 2 = 2	Taxable 6 = 6	Taxable 10 = 10		
Taxable 3 = 3	Taxable 7 = 7			

To program high amount limit for each department

Programming procedure

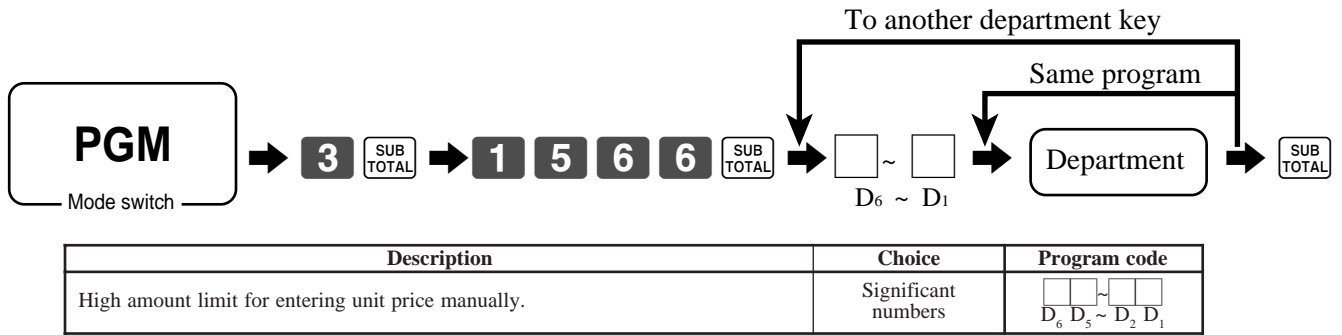

Registering department keys by programming data

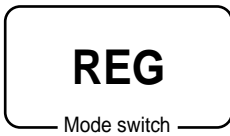

Preset price

OPERATION			RECEIPT			
Item	Unit price	(\$1.00) _{preset}	<div style="border: 1px solid black; padding: 2px; display: inline-block;">2</div> <div style="border: 1px solid black; padding: 2px; display: inline-block;">CA/AMT/TEND</div>	1 DEPT02	.1.00	Department No./ unit price
	Quantity	1		TL	- 1.00	
	Dept.	2		CASH	.1.00	
Payment	Cash	\$1.00				

Preset tax status

OPERATION			RECEIPT			
Item 1	Unit price	(\$2.00) _{preset}	<div style="border: 1px solid black; padding: 2px; display: inline-block;">5</div> <input type="text"/> DATE TIME <div style="border: 1px solid black; padding: 2px; display: inline-block;">3</div> <div style="border: 1px solid black; padding: 2px; display: inline-block;">4</div> <div style="border: 1px solid black; padding: 2px; display: inline-block;">SUB TOTAL</div>	5 DEPT03	T1 .10.00	Tax status
	Quantity	5		1 DEPT04	T2 .2.00	Taxable Amount 1
	Dept.	3		TA1	.10.00	Tax 1
	Taxable	(1) _{preset}		TX1	.0.40	Tax 1
Item 2	Unit price	(\$2.00) _{preset}	<div style="border: 1px solid black; padding: 2px; display: inline-block;">2</div> <div style="border: 1px solid black; padding: 2px; display: inline-block;">0</div> <div style="border: 1px solid black; padding: 2px; display: inline-block;">00</div> <div style="border: 1px solid black; padding: 2px; display: inline-block;">CA/AMT/TEND</div>	TA2	.2.00	Taxable Amount 2
	Quantity	1		TX2	.0.20	Tax 2
	Dept.	4		TL	- 12.60	
	Taxable	(2) _{preset}		CASH	.20.00	
Payment	Cash	\$20.00		CG	.7.40	

Basic Operations and Setups

Locking out high amount limitation

	OPERATION	RECEIPT																											
<table border="1" style="width: 100%; border-collapse: collapse;"> <tr> <td style="width: 15%;">Item</td> <td style="width: 15%;">Unit price</td> <td style="width: 15%;">\$1.05</td> </tr> <tr> <td></td> <td>Quantity</td> <td>1</td> </tr> <tr> <td></td> <td>Dept.</td> <td>3</td> </tr> <tr> <td></td> <td>Max.amount</td> <td>(\$10.00)_{preset}</td> </tr> <tr> <td>Payment</td> <td>Cash</td> <td>\$2.00</td> </tr> </table>	Item	Unit price	\$1.05		Quantity	1		Dept.	3		Max.amount	(\$10.00) _{preset}	Payment	Cash	\$2.00	<div style="font-family: monospace; font-size: 1.2em; margin-bottom: 10px;"> 1 0 5 0 3 </div> <p>ERROR ALARM (E037) (Exceeding high amount)</p> <div style="font-family: monospace; font-size: 1.2em; margin-bottom: 10px;"> 1 0 5 3 </div> <div style="font-family: monospace; font-size: 1.2em; margin-bottom: 10px;"> 2 00 C </div> <div style="font-family: monospace; font-size: 1.2em; margin-bottom: 10px;"> SUB TOTAL </div> <div style="font-family: monospace; font-size: 1.2em;"> CA/AMT /TEND </div>	<table border="1" style="width: 100%; border-collapse: collapse;"> <tr> <td style="width: 60%;">1 DEPT03</td> <td style="width: 5%;"></td> <td style="width: 35%; text-align: right;">· 1.05</td> </tr> <tr> <td>TL</td> <td style="text-align: right;">-</td> <td style="text-align: right;">1.05</td> </tr> <tr> <td>CASH</td> <td></td> <td style="text-align: right;">· 2.00</td> </tr> <tr> <td>C6</td> <td></td> <td style="text-align: right;">· 0.95</td> </tr> </table>	1 DEPT03		· 1.05	TL	-	1.05	CASH		· 2.00	C6		· 0.95
Item	Unit price	\$1.05																											
	Quantity	1																											
	Dept.	3																											
	Max.amount	(\$10.00) _{preset}																											
Payment	Cash	\$2.00																											
1 DEPT03		· 1.05																											
TL	-	1.05																											
CASH		· 2.00																											
C6		· 0.95																											

Preparing and using PLUs

This section describes how to prepare and use PLUs.

CAUTION:

- Before you use PLUs, you must first program the unit price.

Programming PLUs

To program a unit price for each PLU

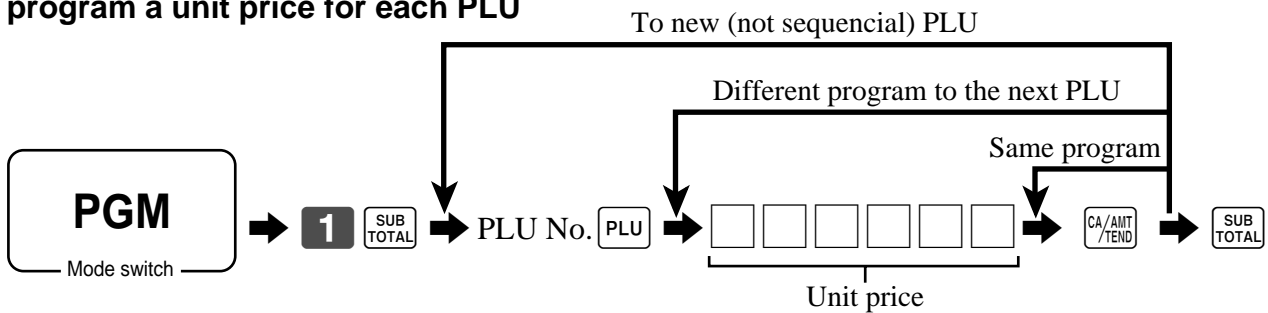

To program tax calculation status for each PLU

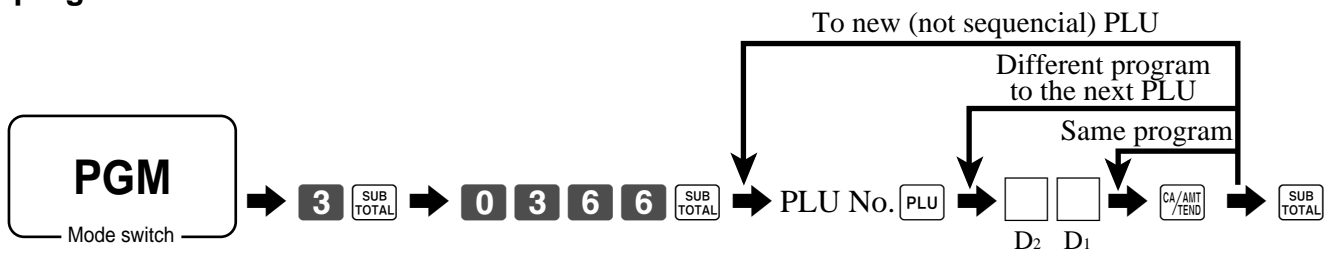

for Singapore				
Always "0"				0 D ₂
Taxable 1 status	a	Yes = 1 No = 0	(a+b+c) D ₁	
Taxable 2 status	b	Yes = 2 No = 0		
Taxable 3 status	c	Yes = 4 No = 0		
for other area				
Non tax = 0	Taxable 4 = 4	Taxable 8 = 8	Significant numbers	D ₂ D ₁
Taxable 1 = 1	Taxable 5 = 5	Taxable 9 = 9		
Taxable 2 = 2	Taxable 6 = 6	Taxable 10 = 10		
Taxable 3 = 3	Taxable 7 = 7			

Registering PLUs



The following examples show how you can use PLUs in various types of registrations.

PLU single item sale

Item	Unit price	(\$2.50) _{preset}
	Quantity	1
	PLU	14
Payment	Cash	\$3.00

OPERATION

1 4
PLU code

PLU

SUB TOTAL

3 00 CA/AMT/TEND

RECEIPT

1 PLU0014	.2.50	PLU No./unit price
TL	- 2.50	
CASH	.3.00	
CG	.0.50	

PLU repeat

Item	Unit price	(\$2.50) _{preset}
	Quantity	3
	PLU	14
Payment	Cash	\$10.00

OPERATION

1 4 **PLU**

PLU

PLU

SUB TOTAL

1 0 00 CA/AMT/TEND

RECEIPT

3 PLU0014	.7.50
TL	- 7.50
CASH	.10.00
CG	.2.50

PLU multiplication

Item	Unit price	(\$2.00) _{preset}
	Quantity	10
	PLU	7
Payment	Cash	\$20.00

OPERATION

1 0 **% DATE TIME**

Quantity
(4-digit integer/2-digit decimal)

7 **PLU**

SUB TOTAL

2 0 00 CA/AMT/TEND

RECEIPT

10 PLU0007	.20.00	Quantity/result or *
10X @1/ 2.00		Quantity/unit q'ty/@
PLU0007	.20.00	Result
TL	- 20.00	
CASH	.20.00	
CG	.0.00	

* See address 0522 of the general function program.

Basic Operations and Setups

Printing VAT breakdowns

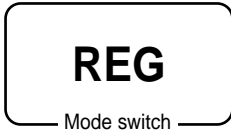

The following example shows how to get VAT breakdown.
Any time you press the **VAT** key in a transaction, VAT breakdown is automatically printed out at the end of the transaction.

Example

Item	Dept. 3	\$10.00
	Quantity	1
	Taxable	(1) _{preset}
Payment	Cash	\$10.00

1 0 00 **1**

SUB TOTAL

VAT

1 0 00 **CA/AMT TEND**

1 DEPT01	T1	·10.00
TA1		·9.62
TX1		·0.38
TL		- 10.00
CASH		·10.00
CG		·0.00

* In case of every receipt needs VAT breakdown lines, select the finalize (**CA/AMT TEND**, **CH**, **CR1**, **CR2**, **CHK/TEND**) key status to "Invoice." Refer to page 65.

Preparing and using discounts

This section describes how to prepare and register discounts.

Programming discounts

To program a rate to the **%-** key

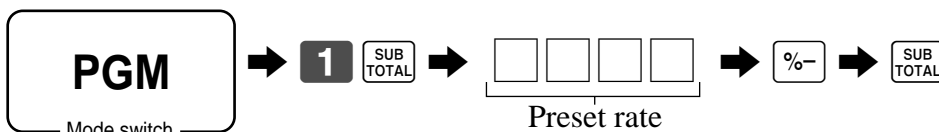

Example:

10% ⇨ **1 0**
 5.5% ⇨ **5 · 5**
 12.34% ⇨ **1 2 · 3 4**

Registering discounts

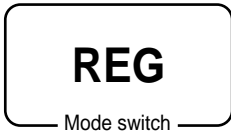

The following example shows how you can use the **%-** key in various types of registration.

Discount for items and subtotals

			OPERATION	RECEIPT																																										
Item 1	Dept. 1	\$5.00	5 00 1	<table border="1" style="width: 100%; border-collapse: collapse;"> <tr><td>1 DEPT01</td><td>T1</td><td>·5.00</td></tr> <tr><td>1 PLU0016</td><td>T2</td><td>·10.00</td></tr> <tr><td>5%</td><td></td><td></td></tr> <tr><td>%-</td><td></td><td>-0.50</td></tr> <tr><td>ST</td><td></td><td>·14.50</td></tr> <tr><td>3.5%</td><td></td><td></td></tr> <tr><td>%-</td><td>T2</td><td>-0.51</td></tr> <tr><td>TA1</td><td></td><td>·5.00</td></tr> <tr><td>TX1</td><td></td><td>·0.20</td></tr> <tr><td>TA2</td><td></td><td>·9.50</td></tr> <tr><td>TX2</td><td></td><td>·0.48</td></tr> <tr><td>TL</td><td></td><td>-14.67</td></tr> <tr><td>CASH</td><td></td><td>·15.00</td></tr> <tr><td>CG</td><td></td><td>·0.33</td></tr> </table>	1 DEPT01	T1	·5.00	1 PLU0016	T2	·10.00	5%			%-		-0.50	ST		·14.50	3.5%			%-	T2	-0.51	TA1		·5.00	TX1		·0.20	TA2		·9.50	TX2		·0.48	TL		-14.67	CASH		·15.00	CG		·0.33
	1 DEPT01	T1	·5.00																																											
	1 PLU0016	T2	·10.00																																											
5%																																														
%-		-0.50																																												
ST		·14.50																																												
3.5%																																														
%-	T2	-0.51																																												
TA1		·5.00																																												
TX1		·0.20																																												
TA2		·9.50																																												
TX2		·0.48																																												
TL		-14.67																																												
CASH		·15.00																																												
CG		·0.33																																												
Quantity	1	1 6 PLU																																												
Taxable	(1) _{preset}	%-																																												
Item 2	PLU 16	(\$10.00) _{preset}	Applies the preset discount rate to the last item registered.																																											
	Quantity	1	SUB TOTAL																																											
	Taxable	(2) _{preset}	3 . 5 %-																																											
Discount	Rate	(5%)_{preset}	The input value takes priority of the preset value.																																											
Subtotal discount	Rate	3.5%	SUB TOTAL																																											
	Taxable	Nontaxable	1 5 00 CA/AMT TEND																																											
Payment	Cash	\$15.00																																												

- You can manually input rates up to 4 digits long (0.01% to 99.99%).

Taxable status of the **%-** key

- Whenever you perform a discount operation on the last item registered, the tax calculation for discount amount is performed in accordance with the tax status programmed for that item.
- Whenever you perform a discount operation on a subtotal amount, the tax calculation for the subtotal amount is performed in accordance with the tax status programmed for the **%-** key (see page 67).

Preparing and using reductions

This section describes how to prepare and register reductions.

Programming for reductions

You can use the **-** key to reduce single item or subtotal amounts.

To program preset reduction amount

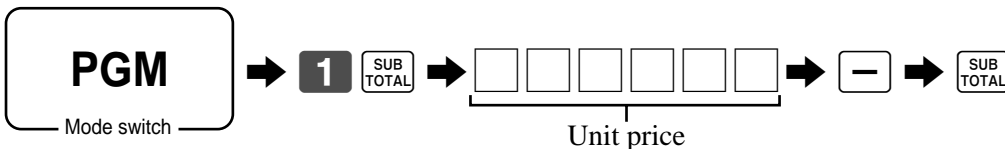







Basic Operations and Setups

Registering reductions



The following examples show how you can use the  key in various types of registration.







Reduction for items

OPERATION				RECEIPT																											
Item 1	Dept. 1	\$5.00	5 00 	<table border="1" style="width: 100%; border-collapse: collapse;"> <tr><td>1 DEPT01</td><td>T1</td><td>·5.00</td></tr> <tr><td>-</td><td>T1</td><td>-0.25</td></tr> <tr><td>1 PLU0045</td><td>T1</td><td>·6.00</td></tr> <tr><td>-</td><td>T1</td><td>-0.50</td></tr> <tr><td>TA1</td><td></td><td>·10.25</td></tr> <tr><td>TX1</td><td></td><td>·0.41</td></tr> <tr><td>TL</td><td></td><td>- 10.66</td></tr> <tr><td>CASH</td><td></td><td>·11.00</td></tr> <tr><td>CG</td><td></td><td>·0.34</td></tr> </table>	1 DEPT01	T1	·5.00	-	T1	-0.25	1 PLU0045	T1	·6.00	-	T1	-0.50	TA1		·10.25	TX1		·0.41	TL		- 10.66	CASH		·11.00	CG		·0.34
	1 DEPT01	T1	·5.00																												
	-	T1	-0.25																												
1 PLU0045	T1	·6.00																													
-	T1	-0.50																													
TA1		·10.25																													
TX1		·0.41																													
TL		- 10.66																													
CASH		·11.00																													
CG		·0.34																													
Quantity	1	2 5 																													
Taxable	(1) _{preset}	4 5 																													
Reduction	Amount	\$0.25																													
Item 2	PLU 45	(\$6.00) _{preset}																													
	Quantity	1																													
	Taxable	(1) _{preset}	1 1 00 																												
Reduction	Amount	(\$0.50)_{preset}																													
Payment	Cash	\$11.00																													

Reduces the last amount registered by the value input.

- You can manually input reduction values up to 7 digits long.
- If you want to subtract the reduction amount from the department or PLU totalizer, program “Net totaling for departments and PLUs” (refer to page 58).

Reduction for subtotal

OPERATION				RECEIPT																														
Item 1	Dept. 1	\$3.00	3 00 	<table border="1" style="width: 100%; border-collapse: collapse;"> <tr><td>1 DEPT01</td><td>T1</td><td>·3.00</td></tr> <tr><td>1 DEPT02</td><td>T2</td><td>·4.00</td></tr> <tr><td>-</td><td></td><td>-0.75</td></tr> <tr><td>TA1</td><td></td><td>·3.00</td></tr> <tr><td>TX1</td><td></td><td>·0.12</td></tr> <tr><td>TA2</td><td></td><td>·4.00</td></tr> <tr><td>TX2</td><td></td><td>·0.20</td></tr> <tr><td>TL</td><td></td><td>- 6.57</td></tr> <tr><td>CASH</td><td></td><td>·7.00</td></tr> <tr><td>CG</td><td></td><td>·0.43</td></tr> </table>	1 DEPT01	T1	·3.00	1 DEPT02	T2	·4.00	-		-0.75	TA1		·3.00	TX1		·0.12	TA2		·4.00	TX2		·0.20	TL		- 6.57	CASH		·7.00	CG		·0.43
	1 DEPT01	T1	·3.00																															
	1 DEPT02	T2	·4.00																															
-		-0.75																																
TA1		·3.00																																
TX1		·0.12																																
TA2		·4.00																																
TX2		·0.20																																
TL		- 6.57																																
CASH		·7.00																																
CG		·0.43																																
Quantity	1	4 00 																																
Taxable	(1) _{preset}																																	
Item 2	Dept. 2	\$4.00	7 5 																															
	Quantity	1																																
	Taxable	(2) _{preset}	7 00 																															
Subtotal	Amount	\$0.75																																
Reduction	Taxable	(No)_{preset}																																
Payment	Cash	\$7.00																																

Reduces the subtotal by the value input here.

Registering credit and check payments

The following examples show how to register credits and payments by check.

REG

Mode switch

Check

OPERATION

RECEIPT

Item	Dept. 1	\$11.00
	Quantity	1
Payment	Check	\$20.00

1 1 00 1
SUB TOTAL
2 0 00 CHK/TEND

1 DEPT01	.11.00
TL	- 11.00
CHECK	.20.00
CG	.9.00

Credit

OPERATION

RECEIPT

Item	Dept. 4	\$15.00
	Quantity	1
Reference	Number	1234
Payment	Credit	\$15.00

1 5 00 4
SUB TOTAL
1 2 3 4 #/NS
CR1

1 DEPT04	.15.00	
#/NS	1234	Reference No.
TL	- 15.00	
CREDIT1	.15.00	

Mixed tender (cash, credit and check)

OPERATION

RECEIPT

Item	Dept. 4	\$55.00
	Quantity	1
Payment	Check	\$30.00
	Cash	\$5.00
	Credit	\$20.00

5 5 00 4
SUB TOTAL
3 0 00 CHK/TEND
5 00 CA/AMT TEND
CR1

1 DEPT04	.55.00
TL	- 55.00
CHECK	.30.00
CASH	.5.00
CREDIT1	.20.00

Basic Operations and Setups

Preparing and registering the Euro

Basic programming for the Euro and its exchange rate

Before registering the Euro, you must define the main currency, and its exchange rate.

If you need to select cash drawer or some rounding specification, please refer to the page 59 for further program (command code "2922" in the general programming).

Description	Choice	Program code
Define the euro as the main currency.	Yes = 0 No = 1	<input type="checkbox"/> D ₁₀
Select rounding option: Round off = 0, Cut off = 1, Round up = 2	Significant number (0 ~ 2)	<input type="checkbox"/> D ₉
Exchange rate (within 6-digits)	Significant numbers	<input type="text"/> <input type="text"/> <input type="text"/> <input type="text"/> <input type="text"/> <input type="text"/> D ₈ D ₇ D ₆ D ₅ D ₄ D ₃
Decimal point position of exchange rate: Integer only = 0 1st decimal place = 1, 2nd decimal place = 2, 3rd decimal place = 3, 4th decimal place = 4, 5th decimal place = 5, 6th decimal place = 6 Example: (D ₈ ~ D ₂) 1Euro = 1.977DM; Set "001977" 1Euro = 1957.77319 Lit; Set "1957772"	Significant number (0 ~ 6)	<input type="checkbox"/> D ₂
Always "0"		<input type="checkbox"/> D ₁



Registering the Euro



The following example shows the basic operation using the currency exchange function.















(1) Case A

Main currency	Local
Payment	Euro
Change	Local
Rate	1 Euro = 0.5 FFr



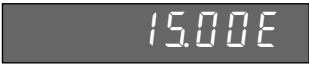







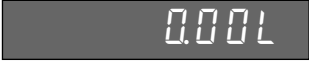
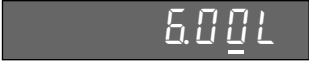

(2) Case B

Main currency	Euro
Payment	Local
Change	Euro
Rate	1 Euro = 0.5 FFr

Case A

OPERATION	DISPLAY
<p>6 0 0 </p> <p> ← Press the  key, which converts the subtotal amount into the sub currency by applying the preset exchange rate.</p> <p> After you press the  key, the result is shown on the display.</p>	<p></p> <p></p>
<p>1 5 00 </p> <p>← Press the  key if you enter the payment in the sub currency.</p>	<p></p> <p></p>
<p> ← Press the  key to finalize the transaction. The change amount is shown in the programmed currency.</p>	<p></p>

Case B

OPERATION	DISPLAY
<p>1 2 00 </p> <p> ← Press the  key, which converts the subtotal amount into the sub currency by applying the preset exchange rate.</p> <p> After you press the  key, the result is shown on the display.</p>	<p></p> <p></p>
<p>6 00 </p> <p>← Press the  key if you enter the payment in the sub currency.</p>	<p></p> <p></p>
<p> ← Press the  key to finalize the transaction. The change amount is shown in the programmed currency.</p>	<p></p>

Printouts

CASE A		CASE B	
1 DEPT01	-6.00	1 DEPT01	€12.00
TL	-6.00	TL	€12.00
	€12.00		-6.00
EURO money		LOCAL money	
CASH	€15.00	CASH	-6.00
CASH	-7.50	CASH	€12.00
CG	-1.50	CG	€0.00

Basic Operations and Setups

Registering returned goods in the REG mode



The following example shows how to use the **[RF]** key in the REG mode to register goods returned by customers.

OPERATION			RECEIPT
Item 1	Dept. 1	\$2.35	<pre> 1 DEPT01 ·2.35 1 DEPT02 ·2.00 1 PLU0001 ·1.20 RF ······ 1 DEPT01 -2.35 RF ······ 1 PLU0001 -1.20 TL - 2.00 CASH ·2.00 </pre>
	Quantity	1	
Item 2	Dept. 2	\$2.00	
	Quantity	1	
Item 3	PLU 1	(\$1.20) _{preset}	
	Quantity	1	
Returned Item 1	Dept. 1	\$2.35	
	Quantity	1	
Returned Item 3	PLU 1	(\$1.20) _{preset}	
	Quantity	1	
Payment	Cash	\$2.00	

2 3 5 1
2 00 2
1 PLU
RF
2 3 5 1
 Press **[RF]** before the item you want to return.
RF
1 PLU
SUB TOTAL
CA / AMT / TEND

Registering returned goods in the RF mode

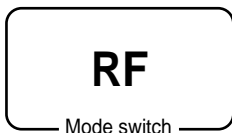

The following examples show how to use the RF mode to register goods returned by customers.

Normal refund transaction

OPERATION			RECEIPT
Returned Item 1	Dept. 1	\$1.50	<pre> RF 03-06-2000(SAT) 11:50 C01 MC#01 000023 2 DEPT01 ·3.00 6 PLU0002 ·7.20 TL - 10.20 CASH ·10.20 </pre>
	Quantity	2	
Returned Item 2	PLU 2	(\$1.20) _{preset}	
	Quantity	6	
Payment	Cash	\$10.20	

1 5 0 1
1
6 X / DATE TIME
2 PLU
CA / AMT / TEND

RF mode symbol

Reduction of amounts paid on refund

OPERATION			RECEIPT		
Returned Item 1	Dept. 3	\$4.00	4 00 3	1 DEPT03	T1 ·4.00
Reduction	Quantity	1	1 5 -	-	T1 -0.15
Returned Item 2	Amount	\$0.15	2 PLU	1 PLU0002	T2 ·1.20
Returned Item 2	PLU 2	(\$1.20) _{preset}	%-	5%	T2 -0.06
Discount	Rate	(5%) _{preset}	SUB TOTAL	TA1	·3.85
Payment	Quantity	1	CA/AMT/TEND	TX1	·0.15
Discount	Rate	(5%) _{preset}		TA2	·1.14
Payment	Cash	\$5.20		TX2	·0.06
				TL	-5.20
				CASH	·5.20

Important!

- To avoid miss registrations in the RF mode, return the mode switch to the former position immediately.

Registering money received on account



The following example shows how to register money received on account. This registration must be performed out of a sale.

OPERATION		RECEIPT	
Received amount	\$700.00	7 00 00 RC	RC ·700.00
Amount can be up to 8 digits.			

Registering money paid out



The following example shows how to register money paid out from the register. This registration must be performed out of a sale.

OPERATION		RECEIPT	
Paid out amount	\$1.50	1 5 0 PD	PD ·1.50
Amount can be up to 8 digits.			

Basic Operations and Setups

Registering loan amounts

REG

Mode switch

Use this procedure to register loan or bank received from the office.

OPERATION

RECEIPT

Item	Note	\$1.00
	Quantity	10
	Note	\$5.00
	Quantity	5
Media	Cash	\$35.00

1 0 DATE TIME
 1 00 LOAN
 5 DATE TIME
 5 00 LOAN
 CA/AMT/TEND

LOAN	· 10.00
LOAN	· 25.00
CASH	· 35.00

Registering pick up amounts

REG

Mode switch

Use this procedure to register pick up money from cash drawer.

OPERATION

RECEIPT

Item	Coin	\$0.50
	Quantity	10
	Coin	\$0.10
	Quantity	5
Media	Cash	\$5.50

1 0 DATE TIME
 5 0 PICK UP
 5 DATE TIME
 1 0 PICK UP
 CA/AMT/TEND

P. UP	· 5.00
P. UP	· 0.50
CASH	· 5.50

Changing media in drawer

REG

Mode switch

Use this procedure to change media in drawer.

OPERATION

RECEIPT

Media	Check	-10.00
	Cash	\$8.00
	Charge	\$2.00

MEDIA CHANGE
 1 0 00 CHK/TEND
 Enter the amount to be changed.
 8 00 CA/AMT/TEND
 2 00 CH

MEDIA CHG	·
CHECK	· 10.00
CASH	· 8.00
CH	· 2.00

Making corrections in a registration

REG

Mode switch

There are three techniques you can use to make corrections in a registration.

- To correct an item that you input but not yet registered.
- To correct the last item you input and registered.
- To cancel all items in a transaction.

To correct an item you input but not yet registered

OPERATION

RECEIPT

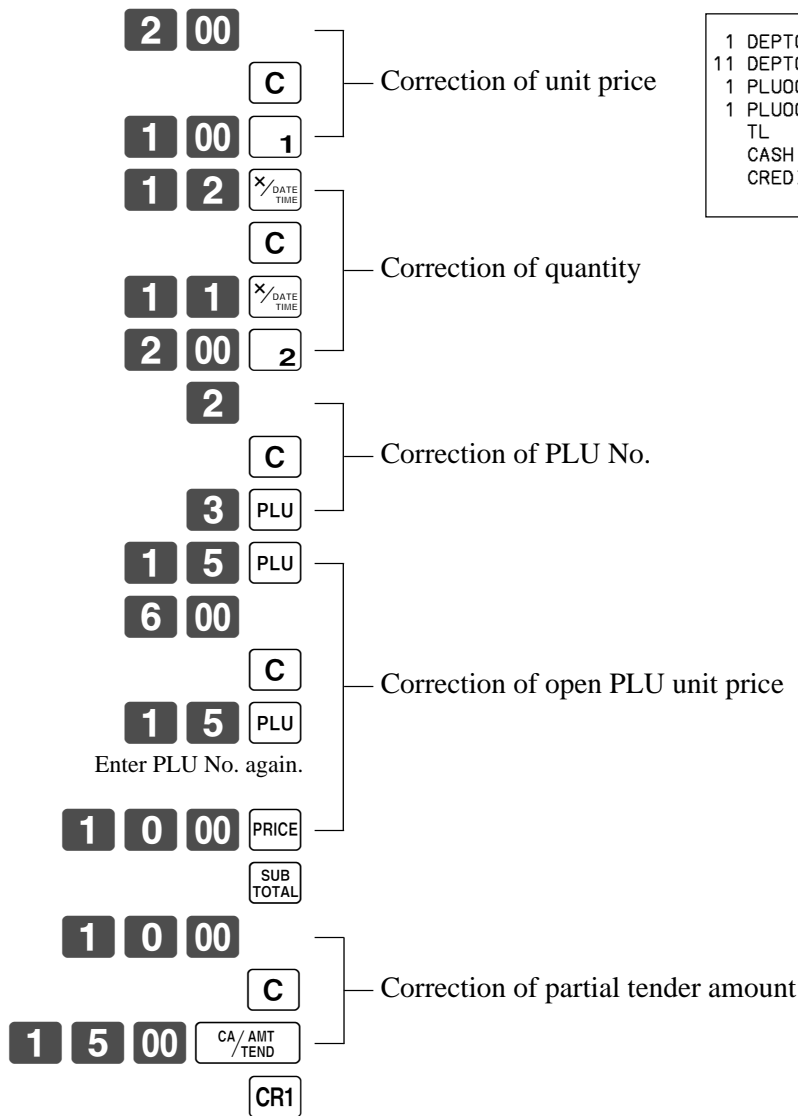

1	DEPT01	-1.00
11	DEPT02	-22.00
1	PLU0003	-1.30
1	PLU0015	-10.00
	TL	-34.30
	CASH	-15.00
	CREDIT1	-19.30

Basic Operations and Setups

To correct an item you input and registered

OPERATION

RECEIPT

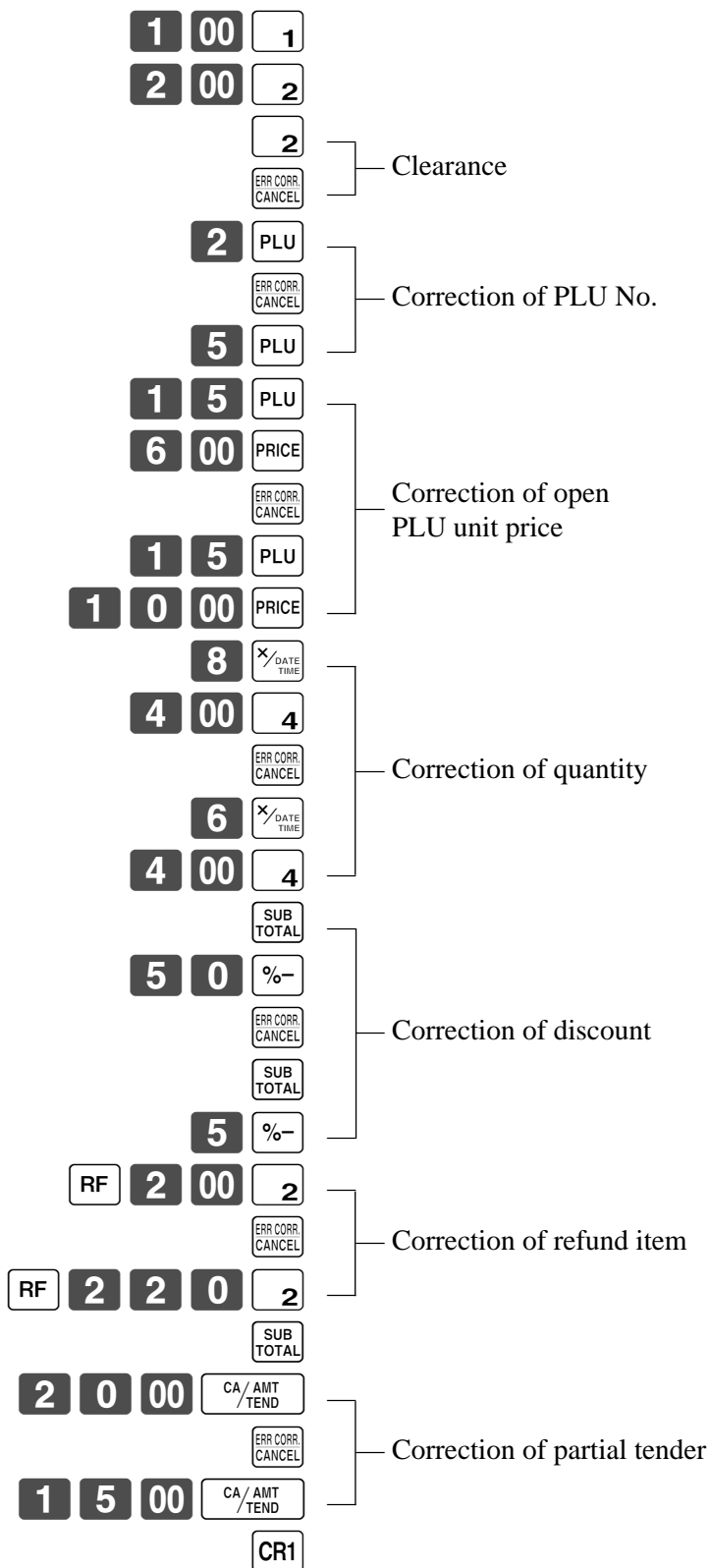

1	DEPT01	-1.00
1	DEPT02	-2.00
1	PLU0005	-1.50
1	PLU0015	-10.00
6	DEPT04	-24.00
	ST	-38.50
	5%	
	%-	-1.93
	RF
1	DEPT02	-2.20
	TL	-34.37
	CASH	15.00
	CREDIT1	19.37

Corrected items are not printed on receipt.

To cancel all items in a transaction

OPERATION	RECEIPT										
<div style="display: flex; justify-content: space-around;"> <div style="border: 1px solid black; padding: 2px;">1</div> <div style="border: 1px solid black; padding: 2px;">00</div> <div style="border: 1px solid black; padding: 2px;">1</div> </div> <div style="display: flex; justify-content: space-around; margin-top: 5px;"> <div style="border: 1px solid black; padding: 2px;">2</div> <div style="border: 1px solid black; padding: 2px;">00</div> <div style="border: 1px solid black; padding: 2px;">2</div> </div> <div style="display: flex; justify-content: space-around; margin-top: 5px;"> <div style="border: 1px solid black; padding: 2px;">3</div> <div style="border: 1px solid black; padding: 2px;">00</div> <div style="border: 1px solid black; padding: 2px;">3</div> </div> <div style="display: flex; justify-content: space-around; margin-top: 5px;"> <div style="border: 1px solid black; padding: 2px;">4</div> <div style="border: 1px solid black; padding: 2px;">00</div> <div style="border: 1px solid black; padding: 2px;">4</div> </div> <div style="margin-top: 5px; text-align: center;"> <div style="border: 1px solid black; padding: 2px; display: inline-block;">SUB TOTAL</div> </div>	<div style="border: 1px solid black; padding: 5px;"> <table style="width: 100%; border-collapse: collapse;"> <tr><td style="width: 80%;">1 DEPT01</td><td style="text-align: right;">-1.00</td></tr> <tr><td>1 DEPT02</td><td style="text-align: right;">-2.00</td></tr> <tr><td>1 DEPT03</td><td style="text-align: right;">-3.00</td></tr> <tr><td>1 DEPT04</td><td style="text-align: right;">-4.00</td></tr> <tr><td>CANCEL</td><td style="text-align: right;">.....</td></tr> </table> </div>	1 DEPT01	-1.00	1 DEPT02	-2.00	1 DEPT03	-3.00	1 DEPT04	-4.00	CANCEL
1 DEPT01	-1.00										
1 DEPT02	-2.00										
1 DEPT03	-3.00										
1 DEPT04	-4.00										
CANCEL										
Pressing <div style="border: 1px solid black; padding: 2px; display: inline-block; font-size: 0.8em;">SUB TOTAL</div> key is necessary to cancel the transaction.											
<div style="border: 1px solid black; padding: 2px; display: inline-block; font-size: 0.8em;">ERR CORR. CANCEL</div>											

No sale registration



You can use the following procedure to open the drawer without registering a sale. This operation must be performed out of a sale.

OPERATION	RECEIPT		
<div style="border: 1px solid black; padding: 2px; display: inline-block; font-size: 0.8em;"># NS</div>	<div style="border: 1px solid black; padding: 5px; display: inline-block;"> <table style="width: 100%; border-collapse: collapse;"> <tr> <td style="width: 80%;">#/NS</td> <td style="text-align: right;">.....</td> </tr> </table> </div>	#/NS
#/NS		

Basic Operations and Setups

Printing the daily sales reset report

This report shows daily sales totals.

OPERATION

REPORT

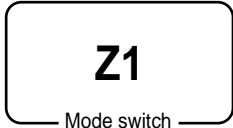

Z	03-06-2000(SAT)	12:45	Date/time
C01	MC#01	000035	Clerk name/mc No./consecutive No.

Z	BATCH	01	Report title

Z	FIX	0001	Fixed total report title/reset counter
		0001011	Report code

GROSS		981.25	Gross total *2
		.6,574.40	
NET	No	111	Net total *2
		.7,057.14	
CAID		.1,919.04	Cash in drawer *2
CHID		.139.04	Charge in drawer *2
CKID		.859.85	Check in drawer *2
CRID(1)		.709.85	Credit in drawer *2

RF	No	3	Refund mode *2
		.10.22	
CUST	CT	111	Number of customer *2

TA1		.2,369.69	Taxable 1 amount *2
TX1		.128.86	Tax 1 amount *2
TA2		.2,172.96	Taxable 2 amount *2
TX2		.217.33	Tax 2 amount *2

GT1		.00000000125478.96	Grand total 1 *2
GT2		.00000000346284.23	Grand total 2 *2
GT3		.00000000123212.75	Grand total 3 *2

Z	TRANS	0001	Function key report title/reset counter
		0001012	Report code

CASH	No	362	Function key count/amount *1
		.1,638.04	
CHARGE	No	56	
		.1,174.85	
RC	No	4	
		.810.00	
PD	No	5	
		.520.00	

CORR	No	14	
		.39.55	
RCT	No	3	
NS	No	5	

Z	DEPT	0001	Department report title/reset counter
		0001015	Report code
DEPT01		203.25	Department count/amount *1
		.1,108.54	
DEPT02		183	
		.1,362.26	
DEPT15		5	Department total count/total amount
		.17.22	
TL		421.25	Department total count/total amount
		.2,872.28	
Z	CASHIER	0001	Clerk report title/reset counter
		0001017	Report code
C01	1	Clerk name/drawer No. *1
GROSS		421.25	Gross total *1
		.2,872.28	
NET	No	111	Net total *1
		.1,845.35	
CAID		.1,057.14	Cash in drawer *1
CHID		.139.04	
C02	1	Clerk name/drawer No.

*1 Zero totalled departments/functions/clerks are not printed by programming.

*2 These items can be skipped by programming.

Advanced Operations and Setups

This chapter describes more sophisticated operations that you can use to suit the needs of your retail environment.

Clerk interrupt function

There are two types of clerk interrupt function, illustrated by PROCEDURE 1 and PROCEDURE 2 below.

- In PROCEDURE 1, each clerk possesses a unique clerk interrupt buffer, and so the clerk interrupt function gives each individual clerk the ability to perform an independent registration operation. In this case, each clerk is individually linked to a unique clerk interrupt buffer.

- In PROCEDURE 2, multiple clerks use the same clerk interrupt buffer, and so a single clerk interrupt operation (clerk change during registration) can be performed any registration is in progress.

In this case, multiple clerks are linked to a single clerk interrupt buffer.

Note the following important points concerning the clerk interrupt function.

1. The register must be programmed to allow the clerk interrupt function.
2. To use the clerk interrupt function, a clerk interrupt buffer must be allocated with the memory allocation operation. Next the manager control operation (X1 mode) should be used to perform clerk assignment for the clerk interrupt function. The clerk interrupt operation cannot be performed by clerks who are not linked to a clerk interrupt buffer.

In the REG1, REG2, and RF modes, clerks can be changed while a transaction is in progress, making it possible for multiple clerks to simultaneously perform registrations in the same mode using a single register. For example, if clerk 1 is interrupted while registering a transaction, clerk 2 can use the same machine to register a different transaction. Then clerk 1 can continue the original registration from the point where it was interrupted.

PROCEDURE 1

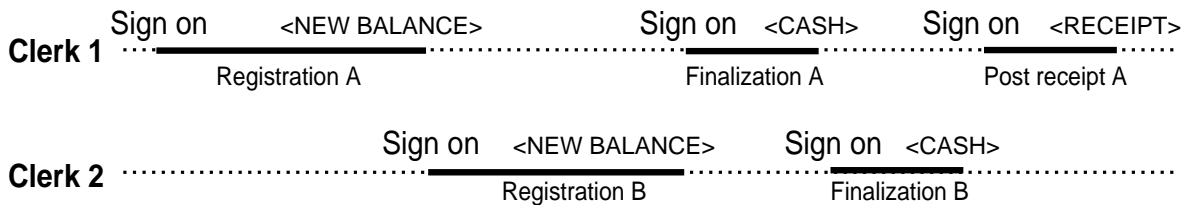

PROCEDURE 2



NOTES

- A guest receipt can be issued following clerk change, and receipts can be issued separately for each clerk.
- A cancel operation can be performed during registration by either of the clerks. When clerk 1 signs back on (after being interrupted by clerk 2), the cancel operation cancels only the items registered after signing back on (only this receipt) or from the top of the transaction. This is selectable by the key program.

Single item cash sales

A department key or PLU programmed with single item sale status finalizes the transaction as soon as it is registered.

The single item sales function cannot work properly if the keyboard does not include <CASH> (the cash key).

The single item sales function can only be used for cash sales.

Example 1

OPERATION			RECEIPT							
Item	Dept. 1	\$1.00	1 00 1	<table style="width: 100%; border-collapse: collapse;"> <tr> <td style="width: 80%;">1 DEPT01</td> <td style="width: 20%; text-align: right;">.1.00</td> </tr> <tr> <td>TL</td> <td style="text-align: right;">- 1.00</td> </tr> <tr> <td>CASH</td> <td style="text-align: right;">.1.00</td> </tr> </table>	1 DEPT01	.1.00	TL	- 1.00	CASH	.1.00
	1 DEPT01	.1.00								
	TL	- 1.00								
CASH	.1.00									
Quantity	1	<p>The transaction is immediately finalized.</p>	<table style="width: 100%; border-collapse: collapse;"> <tr> <td style="width: 80%;"></td> <td style="width: 20%; text-align: right;">Department No./ unit price</td> </tr> <tr> <td></td> <td style="text-align: right;">Total amount</td> </tr> </table>		Department No./ unit price		Total amount			
	Department No./ unit price									
	Total amount									
Status	S.I.S									
Payment	Cash	\$1.00								

Example 2

OPERATION			RECEIPT							
Item	Dept. 1	(\$1.00)	3 X 1	<table style="width: 100%; border-collapse: collapse;"> <tr> <td style="width: 80%;">3 DEPT01</td> <td style="width: 20%; text-align: right;">.3.00</td> </tr> <tr> <td>TL</td> <td style="text-align: right;">- 3.00</td> </tr> <tr> <td>CASH</td> <td style="text-align: right;">.3.00</td> </tr> </table>	3 DEPT01	.3.00	TL	- 3.00	CASH	.3.00
	3 DEPT01	.3.00								
	TL	- 3.00								
CASH	.3.00									
Quantity	3	<p>The transaction is immediately finalized.</p>	<table style="width: 100%; border-collapse: collapse;"> <tr> <td style="width: 80%;"></td> <td style="width: 20%; text-align: right;">DATE TIME</td> </tr> </table>		DATE TIME					
	DATE TIME									
Status	S.I.S									
Payment	Cash	\$3.00								

Example 3

OPERATION			RECEIPT									
Item 1	Dept. 3	\$2.00	2 00 3	<table style="width: 100%; border-collapse: collapse;"> <tr> <td style="width: 80%;">1 DEPT03</td> <td style="width: 20%; text-align: right;">.2.00</td> </tr> <tr> <td>1 DEPT01</td> <td style="text-align: right;">.1.00</td> </tr> <tr> <td>TL</td> <td style="text-align: right;">- 3.00</td> </tr> <tr> <td>CASH</td> <td style="text-align: right;">.3.00</td> </tr> </table>	1 DEPT03	.2.00	1 DEPT01	.1.00	TL	- 3.00	CASH	.3.00
	1 DEPT03	.2.00										
	1 DEPT01	.1.00										
TL	- 3.00											
CASH	.3.00											
Quantity	1	<p>The transaction is not finalized. Because another item is registered before the single item sales department.</p>	<table style="width: 100%; border-collapse: collapse;"> <tr> <td style="width: 80%;"></td> <td style="width: 20%; text-align: right;">CA/AMT TEND</td> </tr> </table>		CA/AMT TEND							
	CA/AMT TEND											
Status	Normal											
Item 2	Dept. 1	(\$1.00)										
	Quantity	1										
Status	S.I.S											
Payment	Cash	\$3.00										

Advanced Operations and Setups

Addition

Addition (plus)

Example

Item 1	Dept. 1	\$1.00
	Quantity	1
	Addition	\$0.10
Item 2	Dept. 1	\$2.00
	Quantity	3
	Addition	3 × (\$0.20)
Payment	Cash	\$7.70

OPERATION

1 **00** **1**
1 **0** **+**
3 × DATE TIME
2 **00** **1**
3 × DATE TIME
+
 CA/AMT
 /TEND

RECEIPT

1	DEPT01	·1.00
	+	·0.10
3	DEPT01	·6.00
	+	·0.60
	TL	- 7.70
	CASH	·7.70

Premium (%+)

Example

Item 1	Dept. 1	\$1.00
	Quantity	1
	Premium	10%
Item 2	Dept. 1	\$2.00
	Quantity	3
Subtotal	Premium	(15%)
Payment	Cash	\$8.17

OPERATION

1 **00** **1**
1 **0** **%+**
3 × DATE TIME
2 **00** **1**
SUB TOTAL
%+
 CA/AMT
 /TEND

RECEIPT

1	DEPT01	·1.00
	10%	
	%+	·0.10
3	DEPT01	·6.00
	ST	·7.10
	15%	
	%+	·1.07
	TL	- 8.17
	CASH	·8.17

Coupon transactions

Note that errors result when the result of a calculation is negative if the cash register is programmed to prohibit credit balances.

Coupon registration using <COUPON> (coupon key)

Example

			OPERATION	RECEIPT																		
Item 1	Dept. 1	\$3.00	2 <input type="checkbox"/> DATE TIME	<table border="1"> <tr><td>2</td><td>DEPT01</td><td>·6.00</td></tr> <tr><td></td><td>CPN</td><td>-1.00</td></tr> <tr><td>1</td><td>DEPT03</td><td>·4.00</td></tr> <tr><td></td><td>CPN</td><td>-1.00</td></tr> <tr><td></td><td>TL</td><td>- 8.00</td></tr> <tr><td></td><td>CASH</td><td>·8.00</td></tr> </table>	2	DEPT01	·6.00		CPN	-1.00	1	DEPT03	·4.00		CPN	-1.00		TL	- 8.00		CASH	·8.00
	2	DEPT01	·6.00																			
		CPN	-1.00																			
1	DEPT03	·4.00																				
	CPN	-1.00																				
	TL	- 8.00																				
	CASH	·8.00																				
Quantity	2		3 00 <input type="checkbox"/> 1																			
Coupon	\$0.50 × 2		2 <input type="checkbox"/> DATE TIME																			
Item 2	Dept. 3	\$4.00	5 0 <input type="checkbox"/> CPN																			
	Quantity	1	4 00 <input type="checkbox"/> 3																			
	Coupon	(\$1.00)	<input type="checkbox"/> CPN																			
Payment	Cash	\$8.00	<input type="checkbox"/> CA / AMT / TEND																			

Coupon registration using <COUPON2> (coupon 2 key)

Example

			OPERATION	RECEIPT																								
Item 1	Dept. 1	\$15.00	1 5 00 <input type="checkbox"/> 1	<table border="1"> <tr><td>1</td><td>DEPT01</td><td>·15.00</td></tr> <tr><td></td><td>CPN2</td><td>· · · · · ·</td></tr> <tr><td>1</td><td>DEPT01</td><td>-1.50</td></tr> <tr><td>1</td><td>PLU0010</td><td>·5.00</td></tr> <tr><td></td><td>CPN2</td><td>· · · · · ·</td></tr> <tr><td>1</td><td>PLU0050</td><td>-0.50</td></tr> <tr><td></td><td>TL</td><td>- 18.00</td></tr> <tr><td></td><td>CASH</td><td>·18.00</td></tr> </table>	1	DEPT01	·15.00		CPN2	· · · · · ·	1	DEPT01	-1.50	1	PLU0010	·5.00		CPN2	· · · · · ·	1	PLU0050	-0.50		TL	- 18.00		CASH	·18.00
	1	DEPT01	·15.00																									
		CPN2	· · · · · ·																									
1	DEPT01	-1.50																										
1	PLU0010	·5.00																										
	CPN2	· · · · · ·																										
1	PLU0050	-0.50																										
	TL	- 18.00																										
	CASH	·18.00																										
Quantity	1		<input type="checkbox"/> CPN2 1 5 0 <input type="checkbox"/> 1																									
Coupon 2 Dept. 1	\$1.50		1 0 <input type="checkbox"/> PLU																									
Item 2	PLU 10	\$5.00	<input type="checkbox"/> CPN2 5 0 <input type="checkbox"/> PLU																									
	Quantity	1																										
	Coupon 2 PLU 50	(\$0.50)																										
Payment	Cash	\$18.00	<input type="checkbox"/> CA / AMT / TEND																									

Advanced Operations and Setups

Arrangement key registrations

Key operations can be assigned to an <ARRANGE> (arrangement key). Then, simply pressing <ARRANGE> performs all of the key functions assigned to it.

Key operations can also be assigned to an address code. Then, when you input the address code using <ARRANGE>, all of the key functions assigned to the address code are performed.

Example 1

OPERATION				RECEIPT
Arrangement 1			ARR	
Item 1	PLU 1	(\$8.00)		1 PLU0001 ·8.00
	Quantity	1		1 PLU0002 ·5.00
Item 2	PLU 2	(\$5.00)		TL - 13.00
	Quantity	1		CASH ·13.00
Payment	Cash	\$13.00		

Example 2

OPERATION				RECEIPT
Arrangement 5			5 ARR	
Item 1	Dept. 1	\$1.00		1 DEPT01 ·1.00
	Quantity	1		1 DEPT02 ·2.00
Item 2	Dept. 2	\$2.00		TL - 3.00
	Quantity	1		CASH ·3.00
Payment	Cash	\$3.00		

Arrangement programming

Arrangement key allocation

Please refer to page 80.

Attribution of <ARRANGEMENT> programming

Please refer to page 69.

The operation in <ARRANGEMENT> programming

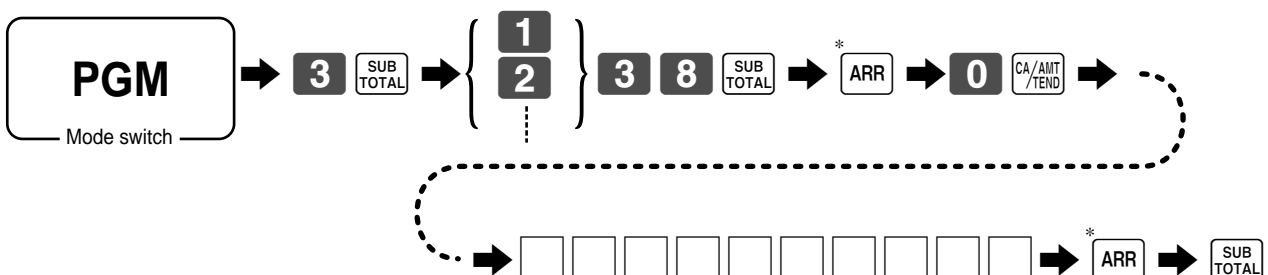

* The same **ARR** should be pressed.

Currency exchange function

When <CE> (currency exchange key) is pressed, a current subtotal including tax is converted directly into foreign currency and the result is displayed, and the subsequent finalization is handled using the foreign currency. The currency exchange function is released by finalizing a transaction, partial tender operation, receipt issuance, or by pressing <SUBTOTAL>.

Before using the currency exchange function, it is necessary to program the conversion rate.

Registering foreign currency

Full amount tender in foreign currency

* Pre-programmed exchange rate: ¥ 100 = \$0.9524

Important!

Tenders in a foreign currency can be registered using **CA/AMT/TEND** and **CHK/TEND** only. Other finalize keys cannot be used.

OPERATION

DISPLAY

RECEIPT

1 0 00 **1**

← Enter the unit price and press the applicable department key.

01 10.00

(Displays in \$)

1	DEPT01	· 10.00
2	DEPT02	· 20.00
	TL	- 30.00
	CE	
	CASH	¥5,000
	CASH	· 47.62
	CG	· 17.62

2 0 00 **2**

← Enter the next unit price and press the applicable department key.

02 20.00

(Displays in \$)

CE **SUB TOTAL**

← Press **CE** and **SUB TOTAL** without entering a numeric value. This operation converts the subtotal (including tax) dollar value into yen by applying a pre-programmed exchange rate. The result is shown on the display and printed on the receipt/journal by programming.

3.150

(Displays in ¥: 3,150)

5 0 00 **CE**

(5,000)

← Enter the amount tendered in yen and press **CE**. This operation converts the entered yen amount into dollars by applying a pre-programmed exchange rate. The result is shown on the display.

5.000

CA/AMT/TEND

← Press to finalize the transaction. Note that you do not need to reenter the dollar amount. The register automatically calculates the change amount due in dollars and shows it on the display, receipts and journal.

17.62

(Displays in \$)

Advanced Operations and Setups

Partial tender in a foreign currency

* Pre-programmed exchange rate: ¥ 100 = \$0.9524

Important!

Partial tender in a foreign currency can be registered using **CA/AMT/TEND** and **CHK/TEND** only. Other finalization keys cannot be used, but the remaining tender can be finalized using any finalize key.

OPERATION	DISPLAY	RECEIPT														
1 0 00 1 ← Enter the unit price and press the applicable department key.	01 10.00 (Displays in \$)	<table border="1"> <tr> <td>1 DEPT01</td> <td>· 10.00</td> </tr> <tr> <td>1 DEPT02</td> <td>· 20.00</td> </tr> <tr> <td>TL</td> <td>- 30.00</td> </tr> <tr> <td>CE</td> <td></td> </tr> <tr> <td>CASH</td> <td>¥2,000</td> </tr> <tr> <td>CASH</td> <td>· 19.05</td> </tr> <tr> <td>CHECK</td> <td>· 10.95</td> </tr> </table>	1 DEPT01	· 10.00	1 DEPT02	· 20.00	TL	- 30.00	CE		CASH	¥2,000	CASH	· 19.05	CHECK	· 10.95
1 DEPT01	· 10.00															
1 DEPT02	· 20.00															
TL	- 30.00															
CE																
CASH	¥2,000															
CASH	· 19.05															
CHECK	· 10.95															
2 0 00 2 ← Enter the next unit price and press the applicable department key.	02 20.00 (Displays in \$)															
CE SUB TOTAL ← Press CE and SUB TOTAL without entering a numeric value. This operation converts the subtotal (including tax) dollar value into yen by applying a pre-programmed exchange rate. The result is shown on the display and printed on the receipt/journal by programming.	3.150 (Displays in ¥: 3,150)															
2 0 00 CE ← Enter the partial amount tendered in yen and press CE . (2,000) <p>This operation converts the entered yen amount into dollars by applying a pre-programmed exchange rate. The result is shown on the display.</p>	2.000															
CA/AMT/TEND ← Press CA/AMT/TEND to specify cash tender for the yen partial tender. Note that you do not need to reenter the dollar amount. The register automatically deducts the dollar equivalent of the yen amount tendered from the total amount due and shows the amount on the display.	10.95 (Displays in \$)															
CHK/TEND ← Press to finalize the transaction.	10.95 (Displays in \$)															

Currency exchange programming

Currency exchange key allocation

Please refer to page 80.

Attribution of <CURRENCY EXCHANGE> programming

Please refer to page 69.

Exchange rate programming

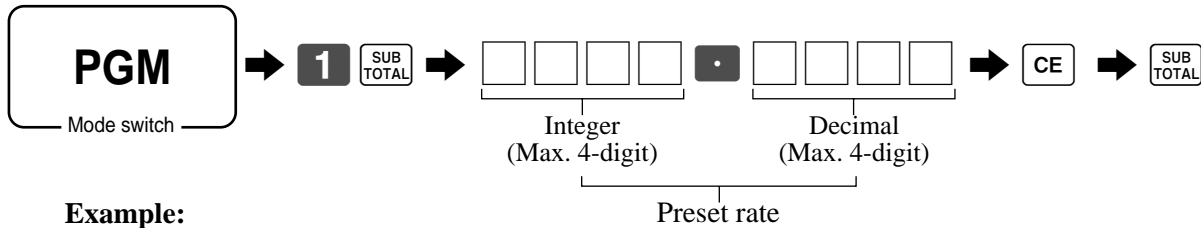

Example:

\$1.00 = ¥110.50 ⇨ **1** · **1** **0** **5**
 ¥100 = \$0.9050 ⇨ **0** · **9** **0** **5**

Temporarily releasing compulsion

<OPEN 2> (open 2 key) can be programmed to release specific compulsion.

Example 1

	OPERATION	RECEIPT																					
<table border="1" style="width: 100%; border-collapse: collapse;"> <tr> <td style="width: 15%;">Item</td> <td style="width: 15%;">Unit price</td> <td style="width: 15%;">\$10.00</td> </tr> <tr> <td></td> <td>Dept.</td> <td>1</td> </tr> <tr> <td>Payment</td> <td>Check</td> <td>\$10.00</td> </tr> <tr> <td colspan="3" style="text-align: center;">Amount tender compulsory</td> </tr> </table>	Item	Unit price	\$10.00		Dept.	1	Payment	Check	\$10.00	Amount tender compulsory			<p>1 0 00 1</p> <p>CHK/TEND</p> <p>Amount tender compulsory (E033)</p> <p>OPEN 2</p> <p>Amount tender compulsory is temporarily released.</p> <p>CHK/TEND</p>	<table border="1" style="width: 100%; border-collapse: collapse;"> <tr> <td style="width: 60%;">1 DEPT01</td> <td style="width: 10%;"></td> <td style="width: 30%; text-align: right;">. 10.00</td> </tr> <tr> <td>TL</td> <td style="text-align: right;">- 10.</td> <td style="text-align: right;">.00</td> </tr> <tr> <td>CHECK</td> <td></td> <td style="text-align: right;">. 10.00</td> </tr> </table>	1 DEPT01		. 10.00	TL	- 10.	.00	CHECK		. 10.00
Item	Unit price	\$10.00																					
	Dept.	1																					
Payment	Check	\$10.00																					
Amount tender compulsory																							
1 DEPT01		. 10.00																					
TL	- 10.	.00																					
CHECK		. 10.00																					

Example 2

	OPERATION	RECEIPT																								
<table border="1" style="width: 100%; border-collapse: collapse;"> <tr> <td colspan="3" style="text-align: center;">Input customer No. compulsory</td> </tr> <tr> <td style="width: 15%;">Item</td> <td style="width: 15%;">Unit price</td> <td style="width: 15%;">\$10.00</td> </tr> <tr> <td></td> <td>Dept.</td> <td>1</td> </tr> <tr> <td>Payment</td> <td>Check</td> <td>\$10.00</td> </tr> </table>	Input customer No. compulsory			Item	Unit price	\$10.00		Dept.	1	Payment	Check	\$10.00	<p>1 0 00 1</p> <p>Input customer No. compulsory (E019)</p> <p>OPEN 2</p> <p>Compulsory is temporarily released.</p> <p>1 0 00 1</p> <p>1 0 00 CHK/TEND</p>	<table border="1" style="width: 100%; border-collapse: collapse;"> <tr> <td style="width: 60%;">1 DEPT01</td> <td style="width: 10%;"></td> <td style="width: 30%; text-align: right;">. 10.00</td> </tr> <tr> <td>TL</td> <td style="text-align: right;">- 10.</td> <td style="text-align: right;">.00</td> </tr> <tr> <td>CHECK</td> <td></td> <td style="text-align: right;">. 10.00</td> </tr> <tr> <td>CG</td> <td></td> <td style="text-align: right;">. 0.00</td> </tr> </table>	1 DEPT01		. 10.00	TL	- 10.	.00	CHECK		. 10.00	CG		. 0.00
Input customer No. compulsory																										
Item	Unit price	\$10.00																								
	Dept.	1																								
Payment	Check	\$10.00																								
1 DEPT01		. 10.00																								
TL	- 10.	.00																								
CHECK		. 10.00																								
CG		. 0.00																								

Advanced Operations and Setups

Programming to clerk

You can program up to 4-digit assigning number (clerk number), trainee status of clerk (i.e. training cashier) and commission rate for each clerk.

Programming clerk number

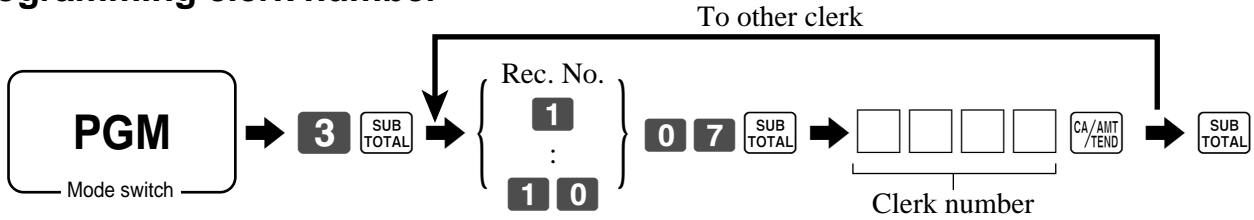

Programming trainee status

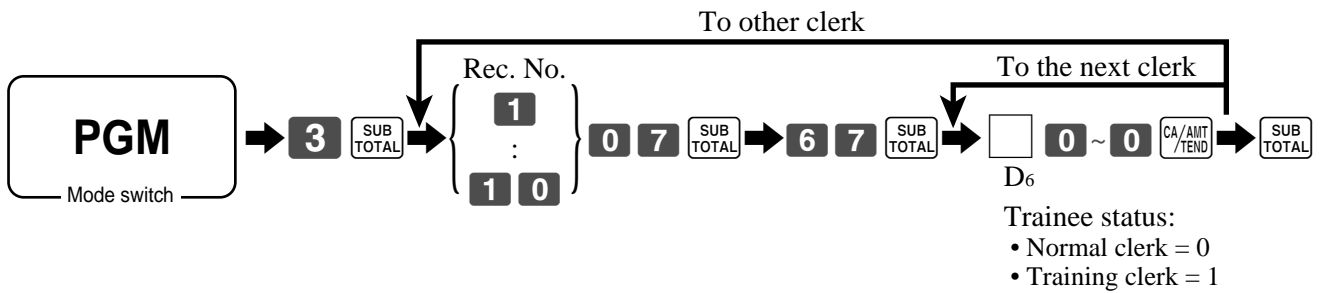

Programming commission rate

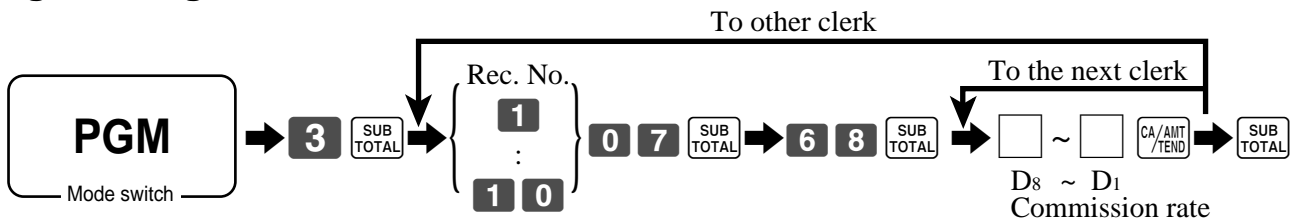

Record No.	Clerk number				Trainee status		Commission rate									
							Commission rate 1				Commission rate 2					
	D4	D3	D2	D1	D6	00000	Integer		Decimal		Integer		Decimal			
1						00000										
2						00000										
3						00000										
4						00000										
5						00000										
6						00000										
7						00000										
8						00000										
9						00000										
10						00000										

Programming machine features

You can program several machine features by the general control file.

Programming to general control file

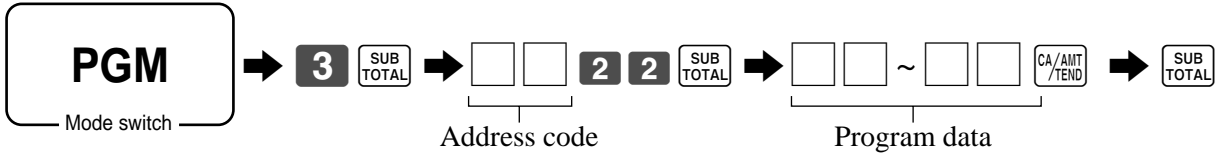

Address code 0122

Description	Choice	Program code
Date order Year/Month/Day = 0, 1 Day/Month/Year = 2, Month/Day/Year = 3	Significant number (0 ~ 3)	<input type="checkbox"/> D ₁₀
Monetary mode □ = 0, □□ = 1, □□□ = 2, □□□□ = 3	Significant number (0 ~ 3)	<input type="checkbox"/> D ₉
Password in Manager mode		<input type="checkbox"/> <input type="checkbox"/> <input type="checkbox"/> <input type="checkbox"/> D ₈ D ₇ D ₆ D ₅
Password in X2/Z2 mode		<input type="checkbox"/> <input type="checkbox"/> <input type="checkbox"/> <input type="checkbox"/> D ₄ D ₃ D ₂ D ₁

Address code 0222

Description	Choice	Program code
Password in PGM1/PGM2 mode	Significant numbers	<input type="checkbox"/> <input type="checkbox"/> <input type="checkbox"/> <input type="checkbox"/> D ₁₀ D ₉ D ₈ D ₇
Always "0"		<input type="checkbox"/> <input type="checkbox"/> D ₆ D ₅
Always "0"		<input type="checkbox"/> <input type="checkbox"/> <input type="checkbox"/> <input type="checkbox"/> D ₄ D ₃ D ₂ D ₁

Address code 0322

Description	Choice	Program code
Reset consecutive number after daily fixed total reset report is issued.	Yes = 1 No = 0	<input type="checkbox"/> D ₈
Always "0"		<input type="checkbox"/> D ₇
Consecutive number start value		<input type="checkbox"/> <input type="checkbox"/> <input type="checkbox"/> D ₆ D ₅ D ₄ <input type="checkbox"/> <input type="checkbox"/> <input type="checkbox"/> D ₃ D ₂ D ₁

Advanced Operations and Setups

Address code 0422

Description		Choice	Program code
Apply rounding for multiplication, discount and premium. No rounding = 0, IF1 = 1, IF2 = 2, Danish = 3 Norwegian = 4, Singaporean = 5		Significant number (0 ~ 5)	<input type="checkbox"/> D ₁₀
Tax system VAT system = 0, Singaporean tax system = 3		Significant number (0 ~ 3)	<input type="checkbox"/> D ₉
Receipt on/off Controlled by receipt on/off switch/key = 0 Always on (issue) = 1, Always off (not issue) = 2		Significant number (0 ~ 2)	<input type="checkbox"/> D ₈
Allow amount tender in RF/REG- mode operation.	a	Yes = 0 No = 2	<input type="checkbox"/> (a+b) D ₇
Cash drawer opening: ①Immediately when the transaction is finalized. ②After validation compulsory is released.	b	① = 0 ② = 4	
Always "0"			<input type="checkbox"/> D ₆
Rounding of results produced by departments and PLUs programmed with package prices and package quantities		Round off = 0 Cut off = 1 Round up = 2	<input type="checkbox"/> D ₅
High amount limit specification for cash in drawer amount. (Sentinel function)		Maximum value (0 ~ 9)	<input type="checkbox"/> <input type="checkbox"/> D ₄ D ₃
		Number of zeros (0 ~ 9)	
Printing of clerk/cashier name on receipt following sign back on following clerk/cashier interrupt operation.		No = 0 Yes = 4	<input type="checkbox"/> D ₂
Enable clerk/cashier interrupt		No = 0 Yes = 1	<input type="checkbox"/> D ₁

Rounding

IF 1 rounding		Danish rounding	
Last 1 digit of subtotal	Result	Last 2 digits of subtotal/change	Result
0 ~ 2	0	00 ~ 12	00
3 ~ 7	5	13 ~ 37	25
8 ~ 9	10	38 ~ 62	50
IF 2 rounding		63 ~ 87	75
Last 1 digit of subtotal	Result	88 ~ 99	100
0 ~ 4	0	Norwegian rounding	
5 ~ 9	10	Last 1 digit of subtotal	Result
Singaporean rounding		00 ~ 24	00
Last 1 digit of tax	Result	25 ~ 74	50
0 ~ 2	0	75 ~ 99	100
3 ~ 7	5		
8 ~ 9	10		

Address code 0522

Description		Choice	Program code
Print total line during finalization.	a	Yes = 0 No = 1	<input type="checkbox"/> (a+b+c) D ₁₀
Time system: ① 24 hour system, ② 12 hour system	b	① = 0 ② = 2	
Feed one line after issuing receipt.	c	No = 0 Yes = 4	
Print consecutive number by double sized letter (up to 3 digits).		No = 0 Yes = 1	<input type="checkbox"/> D ₉
Skip item lines on journal. (journal skip)	a	No = 0 Yes = 1	<input type="checkbox"/> (a+b) D ₈
Break-down set menu printing on receipt, post receipt, guest receipt.	b	No = 0 Yes = 4	
Always "0"			<input type="checkbox"/> <input type="checkbox"/> <input type="checkbox"/> D ₇ D ₆ D ₅
Print number of item sold.	a	No = 0 Yes = 1	<input type="checkbox"/> (a+b) D ₄
Print tax symbols.	b	Yes = 0 No = 2	
Always "0"			<input type="checkbox"/> D ₃
Print multiplication or item consolidation in one line.		Yes = 0 No = 4	<input type="checkbox"/> D ₂
Print <input type="checkbox"/> operation.	a	No = 0 Yes = 1	<input type="checkbox"/> (a+b+c) D ₁
Print number of customers on header.	b	Yes = 0 No = 2	
Print PLU number on receipt.	c	No = 0 Yes = 4	

Address code 1422

Description		Choice	Program code
Monetary mode of foreign currency 1:		Significant number (0 ~ 9)	<input type="checkbox"/> D ₈
Decimal for foreign currency 1: ① Period = 0, ② Comma = 1	a	① = 0 ② = 1	<input type="checkbox"/> (a+b) D ₇
Separator for foreign currency 1: ① Comma = 0, ② Period = 1	b	① = 0 ② = 4	
Monetary mode of foreign currency 2:		Significant number (0 ~ 9)	<input type="checkbox"/> D ₆
Decimal for foreign currency 2: ① Period = 0, ② Comma = 1	a	① = 0 ② = 1	<input type="checkbox"/> (a+b) D ₅
Separator for foreign currency 2: ① Comma = 0, ② Period = 1	b	① = 0 ② = 4	
Monetary mode of foreign currency 3:		Significant number (0 ~ 9)	<input type="checkbox"/> D ₄
Decimal for foreign currency 3: ① Period = 0, ② Comma = 1	a	① = 0 ② = 1	<input type="checkbox"/> (a+b) D ₃
Separator for foreign currency 3: ① Comma = 0, ② Period = 1	b	① = 0 ② = 4	
Monetary mode of foreign currency 4:		Significant number (0 ~ 9)	<input type="checkbox"/> D ₂
Decimal for foreign currency 4: ① Period = 0, ② Comma = 1	a	① = 0 ② = 1	<input type="checkbox"/> (a+b) D ₁
Separator for foreign currency 4: ① Comma = 0, ② Period = 1	b	① = 0 ② = 4	

Advanced Operations and Setups

Address code 0622

Description		Choice	Program code
Follow the taxable status and commission status of +/- to the previous item.	a	Yes = 0 No = 1	<input type="checkbox"/> (a+b+c) D ₁₀
Force to register rate tax before finalization.	b	No = 0 Yes = 2	
Force a money declaration before read/reset operation.	c	No = 0 Yes = 4	
Force to press <input type="checkbox"/> SUB <input type="checkbox"/> TOTAL before finalization	a	No = 0 Yes = 1	<input type="checkbox"/> (a+b+c) D ₉
Allow credit balance while finalization.	b	Yes = 0 No = 2	
Allow multiple refund/register minus operation.	c	Yes = 0 No = 4	
Affect the result of +/-, %+/%- to the item. (Net totaling)	a	No = 0 Yes = 1	<input type="checkbox"/> (a+b) D ₈
Include add-on tax in net total	b	Yes = 0 No = 2	
Include commission in net total.	a	Yes = 0 No = 2	<input type="checkbox"/> (a+b) D ₇
Treatment of department key numeric inputs: ① Treat as amount override ② Treat as quantity extensions	b	① = 0 ② = 4	
Clear the key buffer when a receipt is issued.	a	No = 0 Yes = 1	<input type="checkbox"/> (a+b+c) D ₆
Sounds key catch tone.	b	Yes = 0 No = 2	
Allow to issue post receipt, even if the original one is issued.	c	No = 0 Yes = 4	
Allow program 1 programming in the manager control mode (X1 mode).	a	No = 0 Yes = 1	<input type="checkbox"/> (a+b+c) D ₅
Display "seconds" during time display.	b	No = 0 Yes = 2	
Connect slit drawer.	c	No = 0 Yes = 4	
RF mode status		RF = 0 REG- = 1	<input type="checkbox"/> D ₄
Allow one registration of +/-, %+/%- per one transaction.		No = 0 Yes = 4	<input type="checkbox"/> D ₃
Round on the least significant digit of %+/%- registration.	a	No = 0 Yes = 1	<input type="checkbox"/> (a+b) D ₂
Display separator.	b	Yes = 0 No = 2	
Allow numeric entry while compulsory drawer opening.	a	Yes = 0 No = 2	<input type="checkbox"/> (a+b) D ₁
PLU numbering: ① By memory No. (sequential), ② By random code	b	① = 0 ② = 4	

Address code 1022

Description		Choice	Program code
Print taxable amount 1 on receipt/journal.	a	Yes = 0 No = 1	<input type="checkbox"/> (a+b+c) D ₁₀
Print taxable amount 2 on receipt/journal.	b	Yes = 0 No = 2	
Print taxable amount 3 on receipt/journal.	c	Yes = 0 No = 4	
Print taxable amount 4 on receipt/journal.	a	Yes = 0 No = 1	<input type="checkbox"/> (a+b+c) D ₉
Print taxable amount 5 on receipt/journal.	b	Yes = 0 No = 2	
Print taxable amount 6 on receipt/journal.	c	Yes = 0 No = 4	
Print taxable amount 7 on receipt/journal.	a	Yes = 0 No = 1	<input type="checkbox"/> (a+b+c) D ₈
Print taxable amount 8 on receipt/journal.	b	Yes = 0 No = 2	
Print taxable amount 9 on receipt/journal.	c	Yes = 0 No = 4	
Print taxable amount 10 on receipt/journal.		Yes = 0 No = 1	<input type="checkbox"/> D ₇
Always "0"			<input type="checkbox"/> <input type="checkbox"/> D ₆ D ₅
Till timer (00 ~ 59 minutes)		Significant numbers	<input type="checkbox"/> <input type="checkbox"/> D ₄ D ₃
Till timer (00 ~ 59 seconds)		Significant numbers	<input type="checkbox"/> <input type="checkbox"/> D ₂ D ₁

Address code 2922

Description		Choice	Program code
Monetary mode of sub currency: 0 = 0, 00 = 1, 000 = 2, 0000 = 3		Significant number (0 ~ 3)	<input type="checkbox"/> D ₁₀
Apply rounding for sub currency. No rounding = 0, IF1 = 1, IF2 = 2, Danish = 3 Norwegian = 4, Singaporean = 5		Significant number (0 ~ 5)	<input type="checkbox"/> D ₉
Cash drawer number of sub currency: 0 ~ 2 ("0" means main drawer.)		Significant number	<input type="checkbox"/> D ₈
Selection of the currency of subtotal printout: ① Main currency only, ② Main and sub currency		① = 0 ② = 2	<input type="checkbox"/> D ₇
Selection of the currency of change: ① Main currency, ② Sub currency	a	① = 0 ② = 1	<input type="checkbox"/> (a+b+c) D ₆
Print the cash in drawer of sub currency on reports.	b	No = 0 Yes = 2	
Display symbol of sub currency: ① E, ② L	c	① = 0 ② = 4	
The currency to restrict (to 00, 25, 50, 75) on last two digits for amount tendered: ① Main currency, ② Sub currency	a	① = 0 ② = 1	<input type="checkbox"/> (a+b+c) D ₅
Print rounding total of sub currency on fix total report.	b	No = 0 Yes = 2	
Last 1 digit for sub currency monetary amount entries to 0 or 5.	c	No = 0 Yes = 4	
Always "0"			<input type="checkbox"/> <input type="checkbox"/> <input type="checkbox"/> <input type="checkbox"/> D ₄ D ₃ D ₂ D ₁

* IF 1, IF 2, Danish, Norwegian and Singaporean rounding, refer to page 56.

Advanced Operations and Setups

Address code 1722

Description		Choice	Program code
Money declaration compulsory (cash) in REG/RF mode	a	No = 0 Yes = 1	<input type="checkbox"/> (a+b+c) D ₁₀
Money declaration compulsory (charge) in REG/RF mode	b	No = 0 Yes = 2	
Money declaration compulsory (check) in REG/RF mode	c	No = 0 Yes = 4	
Money declaration compulsory (credit) in REG/RF mode		No = 0 Yes = 1	<input type="checkbox"/> D ₉
Always "0"			<input type="checkbox"/> 0 D ₈
Include VAT amount in commission subtotal.	a	No = 0 Yes = 1	<input type="checkbox"/> (a+b) D ₇
Whenever pressing <PLUS> or <MINUS>, the amount registered is proportioned among all taxable amounts.	b	No = 0 Yes = 2	
Rounding of commission: Round off = 0, Cut off = 1, Round up = 2		Significant number (0 ~ 2)	<input type="checkbox"/> D ₆
Append two zeros in unit price programming.		No = 0 Yes = 1	<input type="checkbox"/> D ₅
Print date on receipt.	a	Yes = 0 No = 1	<input type="checkbox"/> (a+b+c) D ₄
Print date on journal.	b	Yes = 0 No = 2	
Print consecutive number on receipt/journal.	c	Yes = 0 No = 4	
Print time on receipt.	a	Yes = 0 No = 1	<input type="checkbox"/> (a+b+c) D ₃
Print time on journal.	b	Yes = 0 No = 2	
Merge the same department/PLU registration on buffered receipt and post receipt. (Item consolidation)	c	Yes = 0 No = 4	
Always "0"			<input type="checkbox"/> <input type="checkbox"/> D ₂ D ₁

Address code 1922

Description	Choice	Program code
Print double-height characters.	No = 0 Yes = 1	<input type="checkbox"/> D ₇
Always "0"		<input type="checkbox"/> <input type="checkbox"/> <input type="checkbox"/> <input type="checkbox"/> <input type="checkbox"/> <input type="checkbox"/> D ₆ D ₅ D ₄ D ₃ D ₂ D ₁

Address code 2122

Description	Choice	Program code
Receipt logo type: ① Graphic type, ② Character type	a	<input type="checkbox"/> (a+b) D ₁₀
Print receipt back print pattern.	b	No = 0 Yes = 4
Print commercial message on guest receipt.	a	No = 0 Yes = 1
Print bottom message on guest receipt.	b	No = 0 Yes = 2
Print intermediate message on guest receipt.	c	No = 0 Yes = 4
Print bill top message.	a	No = 0 Yes = 1
Print bill copy message.	b	No = 0 Yes = 2
Print bill bottom message.	c	No = 0 Yes = 4
Always "0"		<input type="checkbox"/> 0 D ₇
Print commercial message on receipts in REG/RF mode.	a	No = 0 Yes = 1
Print bottom message on receipts in REG/RF mode.	b	No = 0 Yes = 2
Print commercial message on journal in REG/RF mode.	c	No = 0 Yes = 4
Print bottom message on journal in REG/RF mode.	a	No = 0 Yes = 1
Print commercial message on receipts in X/Z mode.	b	No = 0 Yes = 2
Print bottom message on receipts in X/Z mode.	c	No = 0 Yes = 4
Print commercial message on journal in X/Z mode.	a	No = 0 Yes = 1
Print bottom message on journal in X/Z mode.	b	No = 0 Yes = 2
Print commercial message on receipt in PGM mode.	c	No = 0 Yes = 4
Print bottom message on receipt in PGM mode.	a	No = 0 Yes = 1
Print commercial message on journal in PGM mode.	b	No = 0 Yes = 2
Print bottom message on journal in PGM mode.	c	No = 0 Yes = 4
Print commercial message on FC or AUTO-PGM receipts.	a	No = 0 Yes = 1
Print bottom message on FC or AUTO-PGM receipts.	b	No = 0 Yes = 2
Print commercial message on FC or AUTO-PGM journal.	c	No = 0 Yes = 4
Print bottom message on FC or AUTO-PGM journal.		No = 0 Yes = 1 <input type="checkbox"/> D ₁

Advanced Operations and Setups

Address code 3022

Description	Choice	Program code						
Journal compressed print (print by half height characters)	No = 0 Yes = 1	<input type="checkbox"/> D ₄						
Always "0"		<table border="1" style="display: inline-table; vertical-align: middle;"> <tr> <td style="padding: 2px;">0</td> <td style="padding: 2px;">0</td> <td style="padding: 2px;">0</td> </tr> <tr> <td style="padding: 2px; font-size: small;">D₃</td> <td style="padding: 2px; font-size: small;">D₂</td> <td style="padding: 2px; font-size: small;">D₁</td> </tr> </table>	0	0	0	D ₃	D ₂	D ₁
0	0	0						
D ₃	D ₂	D ₁						

Programming department/PLU

There are two ways to program to department/PLU, batch feature programming and individual feature programming.

Batch feature programming to department/PLU

- Department

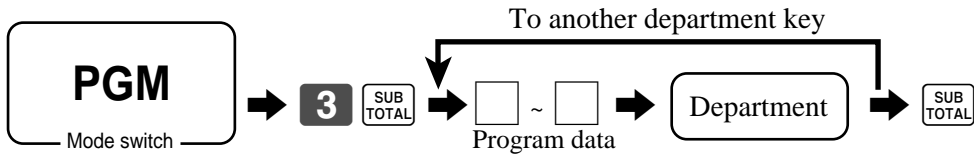

- PLU

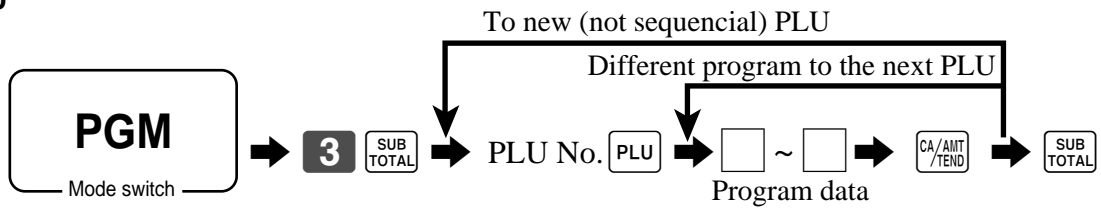

• Program data

Description		Choice	Program code
Single item control: Normal receipt = 0, Single item receipt = 3		Significant number	<input type="checkbox"/> D ₁₂
Always "0"			<input type="checkbox"/> D ₁₁
Normal/condiment/preparation Normal item = 0, Condiment = 1, Preparation = 2		Significant number	<input type="checkbox"/> D ₁₀
Enable operation in RF/REG- mode.	a	Yes = 0 No = 1	<input type="checkbox"/> (a+b+c) D ₉
Enable operation in REG 2 mode.	b	Yes = 0 No = 2	
Enable operation in REG 1 mode.	c	Yes = 0 No = 4	
Taxable status: See below.			<input type="checkbox"/> <input type="checkbox"/> D ₈ D ₇
Enable 0 unit price.	a	No = 0 Yes = 1	<input type="checkbox"/> (a+b+c) D ₆
Enable negative price.	b	No = 0 Yes = 2	
Hash	c	No = 0 Yes = 4	
Always "0"			<input type="checkbox"/> D ₅
Low digit limitation (LDL) for manually entered unit price.		Significant number	<input type="checkbox"/> D ₄
Multiple validation: (If "No", only one validation is possible.)	a	Yes = 0 No = 1	<input type="checkbox"/> (a+b) D ₃
Open PLU (Only effective for PLU)	b	No = 0 Yes = 4	
Commission 1	a	No = 0 Yes = 1	<input type="checkbox"/> (a+b) D ₂
Commission 2	b	No = 0 Yes = 2	
Compulsory number of condiment/preparation PLU input.		Significant number (0 ~ 8)	<input type="checkbox"/> D ₁

Taxable status

for Singapore			
Always "0"			<input type="checkbox"/> D ₈
Taxable 1 status	a	Yes = 1 No = 0	<input type="checkbox"/> (a+b+c) D ₇
Taxable 2 status	b	Yes = 2 No = 0	
Taxable 3 status	c	Yes = 4 No = 0	
for other area			
Non tax = 0 Taxable 1 = 1 Taxable 2 = 2 Taxable 3 = 3	Taxable 4 = 4 Taxable 5 = 5 Taxable 6 = 6 Taxable 7 = 7	Taxable 8 = 8 Taxable 9 = 9 Taxable 10 = 10	Significant numbers <input type="checkbox"/> <input type="checkbox"/> D ₈ D ₇

Advanced Operations and Setups

Individual feature programming to department/PLU

• Department



• PLU

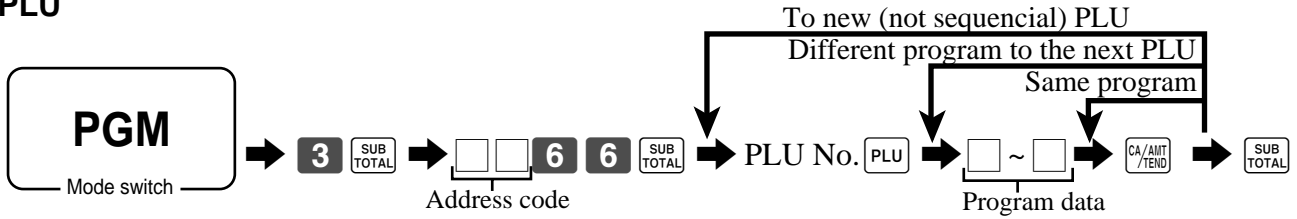

• Program data

Address code 1166

Description	Choice	Program code
Link group record number: (00 ~ 15)	Significant numbers	<input type="text"/> <input type="text"/> D ₆ D ₅
Link department record number: (00 ~ 15) (for PLU)	Significant numbers	<input type="text"/> <input type="text"/> D ₄ D ₃
Always "0"		<input type="text"/> <input type="text"/> D ₂ D ₁

Address code 1266

Description	Choice	Program code
PLU random code (only for PLU)	Significant numbers	<input type="text"/> <input type="text"/> <input type="text"/> <input type="text"/> D ₆ D ₅ ~ D ₂ D ₁

Address code 1366

Description	Choice	Program code
Set menu table record number (only for PLU)	Significant numbers	<input type="text"/> <input type="text"/> <input type="text"/> <input type="text"/> D ₆ D ₅ D ₄ D ₃
Set menu table file number (only for PLU) Always "28"		<input type="text"/> <input type="text"/> D ₂ D ₁

Address code 1566

Description	Choice	Program code
High amount limit for entering unit price manually.	Significant numbers	<input type="text"/> <input type="text"/> <input type="text"/> <input type="text"/> D ₆ D ₅ ~ D ₂ D ₁

Programming to transaction keys

Procedure

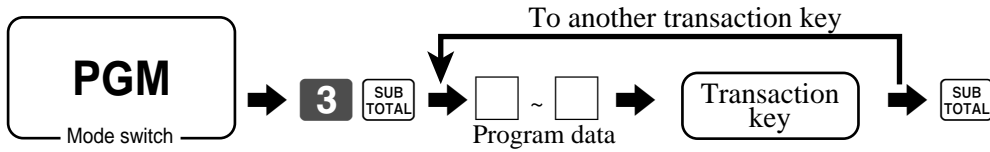

Data

<CASH>, <CHARGE>, <CHECK>

Description		Choice	Program code
Restriction (to 00, 25, 50, 75) on last two digits for amount tendered (Only for <CASH> in Danish rounding) ^{*4}		No = 0 Yes = 4	<input type="checkbox"/> D ₁₀
Disable operation in RF/REG- mode. ^{*3 *4}	a	No = 0 Yes = 1	<input type="checkbox"/> (a+b+c) D ₉
Disable operation in REG2 mode. ^{*3 *4}	b	No = 0 Yes = 2	
Disable operation in REG1 mode. ^{*3 *4}	c	No = 0 Yes = 4	
Always "0"			<input type="checkbox"/> D ₈
Prohibit entry of a partial payment	a	No = 0 Yes = 1	<input type="checkbox"/> (a+b+c) D ₇
Prohibit the entry of the amount tendered.	b	No = 0 Yes = 2	
Force entry of the amount tendered.	c	No = 0 Yes = 4	
Print VAT breakdown. ^{*1 *3}	a	No = 0 Yes = 1	<input type="checkbox"/> (a+b+c) D ₆
Check cashing commission (Only for <CHECK>) ^{*2} ① Use an amount ② Use a rate	b	Amount = 0 Rate = 2	
Validation amount ^{*2 *3} ① Print subtotal amount ② Print amount tendered	c	Subtotal = 0 Tender = 4	
Always "0"			<input type="checkbox"/> D ₅
High amount limit specification for subtotal and tendering amounts. ^{*2}	Maximum value (0 ~ 9)		<input type="checkbox"/> <input type="checkbox"/> D ₄ D ₃
	Number of zeros (0 ~ 9)		
High amount limit specification for change amount due.	Maximum value (0 ~ 9)		<input type="checkbox"/> <input type="checkbox"/> D ₂ D ₁
	Number of zeros (0 ~ 9)		

*1 Those are valid options for SINGLE ITEM as well.

*2 Those are valid options for CASHING A CHECK as well.

*3 Those are valid options for CURRENCY EXCHANGE (include partial tender) as well.

*4 Those are valid options for MEDIA CHANGE (include partial tender) as well.

Advanced Operations and Setups

<CREDIT>

Description		Choice	Program code
Disable operation in RF/REG- mode. *1	a	No = 0 Yes = 1	<input type="checkbox"/> (a+b+c) D ₉
Disable operation in REG2 mode. *1	b	No = 0 Yes = 2	
Disable operation in REG1 mode. *1	c	No = 0 Yes = 4	
Always "0"			<input type="checkbox"/> D ₈
Prohibit entry of a partial payment	a	No = 0 Yes = 1	<input type="checkbox"/> (a+b+c) D ₇
Prohibit the entry of the amount tendered.	b	No = 0 Yes = 2	
Force entry of the amount tendered.	c	No = 0 Yes = 4	
Print VAT breakdown.	a	No = 0 Yes = 1	<input type="checkbox"/> (a+b) D ₆
Validation amount ① Print subtotal amount ② Print amount tendered	b	Subtotal = 0 Tender = 4	
Always "0"			<input type="checkbox"/> D ₅
High amount limit specification for subtotal and tendering amounts:		Maximum value (0 ~ 9)	<input type="checkbox"/> <input type="checkbox"/> D ₄ D ₃
		Number of zeros (0 ~ 9)	
Always "0"			<input type="checkbox"/> D ₂
Specify credit in drawer total in the fixed totalizer. *1		Significant number (0 ~ 4)	<input type="checkbox"/> D ₁

*1 Those are valid options for MEDIA CHANGE (include partial tender) as well.

<RECEIVED ON ACCOUNT>, <PAID OUT>

Description		Choice	Program code
Disable operation in RF/REG- mode.	a	No = 0 Yes = 1	<input type="checkbox"/> (a+b+c) D ₉
Disable operation in REG2 mode.	b	No = 0 Yes = 2	
Disable operation in REG1 mode.	c	No = 0 Yes = 4	
Always "0"			<input type="checkbox"/> ~ <input type="checkbox"/> D ₈ ~ D ₅
High amount limit specification for entering amounts		Maximum value (0 ~ 9)	<input type="checkbox"/> <input type="checkbox"/> D ₄ D ₃
		Number of zeros (0 ~ 9)	
Always "0"			<input type="checkbox"/> <input type="checkbox"/> D ₂ D ₁

<#/NO SALE>

Description		Choice	Program code
Disable operation in RF/REG- mode.	a	No = 0 Yes = 1	<input type="checkbox"/> (a+b+c) D ₉
Disable operation in REG2 mode.	b	No = 0 Yes = 2	
Disable operation in REG1 mode.	c	No = 0 Yes = 4	
Always "0"			<input type="checkbox"/> D ₈
Allow mode change or clerk change after non-add registration as first transaction. (only for non-add function)		Yes = 1 No = 0	<input type="checkbox"/> D ₇
Always "0"			<input type="checkbox"/> ~ <input type="checkbox"/> D ₆ ~ D ₁

<%+>, <%->

Description		Choice	Program code
Disable operation in RF/REG- mode.	a	No = 0 Yes = 1	<input type="checkbox"/> (a+b+c) D ₉
Disable operation in REG2 mode.	b	No = 0 Yes = 2	
Disable operation in REG1 mode.	c	No = 0 Yes = 4	
Taxable status: See below.			<input type="checkbox"/> <input type="checkbox"/> D ₈ D ₇
Prohibit manual rate override.		No = 0 Yes = 2	<input type="checkbox"/> D ₆
Rounding: Round off = 0, cut off = 1, round up = 2		Significant number	<input type="checkbox"/> D ₅
Allow key operation after <SUBTOTAL>.	a	Yes = 0 No = 1	<input type="checkbox"/> (a+b) D ₄
Allow key operation after item registration.	b	Yes = 0 No = 4	
Always "0"			<input type="checkbox"/> D ₃
Commission status: Commission 1 = 1, Commission 2 = 2, None = 0		Significant number	<input type="checkbox"/> D ₂
Always "0"			<input type="checkbox"/> D ₁

Taxable status

for Singapore			
Always "0"			<input type="checkbox"/> D ₈
Taxable 1 status	a	Yes = 1 No = 0	<input type="checkbox"/> (a+b+c) D ₇
Taxable 2 status	b	Yes = 2 No = 0	
Taxable 3 status	c	Yes = 4 No = 0	
for other area			
Non tax = 0 Taxable 1 = 1 Taxable 2 = 2 Taxable 3 = 3	Taxable 4 = 4 Taxable 5 = 5 Taxable 6 = 6 Taxable 7 = 7	Taxable 8 = 8 Taxable 9 = 9 Taxable 10 = 10 Alltaxable = 99	Significant numbers <input type="checkbox"/> <input type="checkbox"/> D ₈ D ₇

Advanced Operations and Setups

<+>, <->, <COUPON>

Description		Choice	Program code
Disable operation in RF/REG- mode.	a	No = 0 Yes = 1	<input type="checkbox"/> (a+b+c) D ₉
Disable operation in REG2 mode.	b	No = 0 Yes = 2	
Disable operation in REG1 mode.	c	No = 0 Yes = 4	
Taxable status: See below.			<input type="checkbox"/> <input type="checkbox"/> D ₈ D ₇
Allow credit balance. (-, CPN only)		No = 0 Yes = 1	<input type="checkbox"/> D ₆
Always "0"			<input type="checkbox"/> D ₅
Allow key operation after <SUBTOTAL>.	a	Yes = 0 No = 1	<input type="checkbox"/> (a+b) D ₄
Allow key operation after item registration.	b	Yes = 0 No = 4	
High digit limitation (HDL) for manually entered unit price ("9" means NOT allow manual entry.)		Significant number	<input type="checkbox"/> D ₃
Commission 1	a	No = 0 Yes = 1	<input type="checkbox"/> (a+b) D ₂
Commission 2	b	No = 0 Yes = 2	
Always "0"			<input type="checkbox"/> D ₁

Taxable status

for Singapore			
Always "0"			<input type="checkbox"/> D ₈
Taxable 1 status	a	Yes = 1 No = 0	<input type="checkbox"/> (a+b+c) D ₇
Taxable 2 status	b	Yes = 2 No = 0	
Taxable 3 status	c	Yes = 4 No = 0	
for other area			
Non tax = 0	Taxable 4 = 4	Taxable 8 = 8	Significant numbers <input type="checkbox"/> <input type="checkbox"/> D ₈ D ₇
Taxable 1 = 1	Taxable 5 = 5	Taxable 9 = 9	
Taxable 2 = 2	Taxable 6 = 6	Taxable 10 = 10	
Taxable 3 = 3	Taxable 7 = 7	Alltaxable = 99	

<ARRANGEMENT>

Description		Choice	Program code
Secret code (0000 ~ 9999)		Yes = 0 No = 1	<input type="text"/> <input type="text"/> <input type="text"/> <input type="text"/> D ₁₄ D ₁₃ D ₁₂ D ₁₁
Enable operation in X1 mode.	a	Yes = 0 No = 1	<input type="checkbox"/> (a+b+c) D ₁₀
Enable operation in Z1 mode.	b	Yes = 0 No = 2	
Enable operation in X2/Z2 mode.	c	Yes = 0 No = 4	
Enable operation in RF/REG- mode.	a	Yes = 0 No = 1	<input type="checkbox"/> (a+b+c) D ₉
Enable operation in REG2 mode.	b	Yes = 0 No = 2	
Enable operation in REG1 mode.	c	Yes = 0 No = 4	
Always "0"			<input type="checkbox"/> D ₈
Treat numeric entry as arrange table number		No = 0 Yes = 1	<input type="checkbox"/> D ₇
Arrangement table link number		Significant numbers	<input type="text"/> ~ <input type="text"/> D ₆ ~ D ₁

<CURRENCY EXCHANGE>

Description		Choice	Program code
Disable operation in RF/REG- mode.	a	No = 0 Yes = 1	<input type="checkbox"/> (a+b+c) D ₉
Disable operation in REG2 mode.	b	No = 0 Yes = 2	
Disable operation in REG1 mode.	c	No = 0 Yes = 4	
Always "0"			<input type="checkbox"/> D ₈
Define amount symbol. (0, 1 ~ 4) ("0" means local currency symbol.)		Significant number	<input type="checkbox"/> D ₇
Define foreign currency totalizer. (0, 1 ~ 4) ("0" treats as "1".)		Significant number	<input type="checkbox"/> D ₆
Rounding: Round off = 0, cut off = 1, round up = 2		Significant number	<input type="checkbox"/> D ₅
Always "0"			<input type="checkbox"/> D ₄
Monetary mode (0 ~ 9): <input type="text"/> <input type="text"/> <input type="text"/> = 2, <input type="text"/> <input type="text"/> = 1, <input type="text"/> = 0		Significant number	<input type="checkbox"/> D ₃
Monetary symbol for decimal	a	Decimal = 0 Comma = 1	<input type="checkbox"/> (a+b) D ₂
Monetary symbol for separator	b	Comma = 0 Decimal = 4	
Assigning drawer number: 0 ~ 2 ("0" means drawer 1.)		Significant number	<input type="checkbox"/> D ₁

Advanced Operations and Setups

<POST RECEIPT>

Description		Choice	Program code
Maximum number of post receipts (0 ~ 9) ("0" means 1 post receipt.)		Significant number	<input type="text"/> D ₁₂
Always "0"			<input type="text"/> <input type="text"/> D ₁₁ D ₁₀
Disable operation in RF/REG- mode.	a	No = 0 Yes = 1	<input type="text"/> (a+b+c) D ₉
Disable operation in REG2 mode.	b	No = 0 Yes = 2	
Disable operation in REG1 mode.	c	No = 0 Yes = 4	
Always "0"			<input type="text"/> D ₈
Print current time on guest receipt.		No = 0 Yes = 4	<input type="text"/> D ₇
Clear finalized check.		Yes = 0 No = 1	<input type="text"/> D ₆
Always "0"			<input type="text"/> <input type="text"/> <input type="text"/> D ₅ D ₄ D ₃
Line number of guest bottom message (00 ~ 10): ("00" means no bottom message.)		Significant number	<input type="text"/> <input type="text"/> D ₂ D ₁

<MULTIPLICATION>, <QUANTITY/FOR>, <SQUARE>, <CUBE>

Description		Choice	Program code
Disable operation in RF/REG- mode.	a	No = 0 Yes = 1	<input type="text"/> (a+b+c) D ₉
Disable operation in REG2 mode.	b	No = 0 Yes = 2	
Disable operation in REG1 mode.	c	No = 0 Yes = 4	
Always "0"			<input type="text"/> <input type="text"/> D ₈ D ₇
Multiplication procedure: (<X> only) ① Quantity × Amount, ② Amount × Quantity		① = 0 ② = 1	<input type="text"/> D ₆
Rounding: Round off = 0, cut off = 1, round up = 2		Significant number	<input type="text"/> D ₅
Always "0"			<input type="text"/> ~ <input type="text"/> D ₄ ~ D ₁

Character programming can be performed in two ways:

- Character keyboard programming (see page 78),
or
- Entering characters by code (see page 79.)

Programming descriptors and messages

The following descriptors and messages can be programmed;

- Clerk name
- Fix totalizer
- Special character
- PLU item descriptor
- Messages
- Report header
- Department key descriptor
- Machine number

Programming clerk name and messages

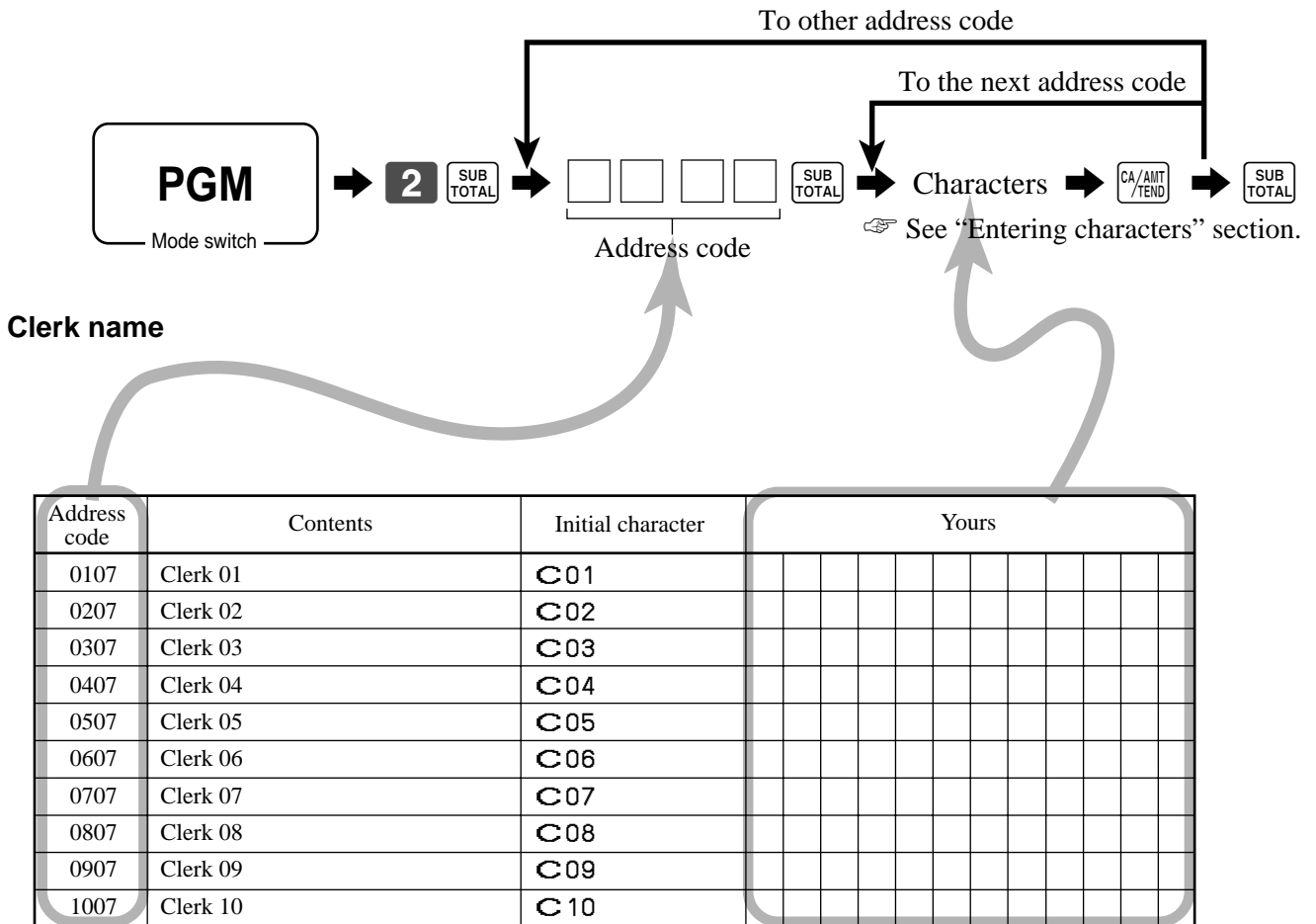

Advanced Operations and Setups

Message

Address code	Contents	Initial character	Yours															
0132	1st line of logo message	YOUR RECEIPT																
0232	2nd line of logo message	THANK YOU																
0332	3rd line of logo message	CALL AGAIN																
0432	4th line of logo message																	
0532 *	1st line of commercial message																	
0632 *	2nd line of commercial message																	
0732 *	3rd line of commercial message																	
0832 *	4th line of commercial message																	
0932 *	1st line of bottom message																	
1032 *	2nd line of bottom message																	
1132 *	3rd line of bottom message																	
1232 *	4th line of bottom message																	
1332 *	1st line of bill top message																	
1432 *	2nd line of bill top message																	
1532 *	3rd line of bill top message																	
1632 *	4th line of bill top message																	
1732 *	1st line of bill copy message																	
1832 *	2nd line of bill copy message																	
1932 *	3rd line of bill copy message																	
2032 *	4th line of bill copy message																	
2132 *	1st line of bill bottom message																	
2232 *	2nd line of bill bottom message																	
2332 *	3rd line of bill bottom message																	
2432 *	4th line of bill bottom message																	
2532 *	Post receipt message																	
2632 *	1st line of guest intermediate msg.																	
2732 *	2nd line of guest intermediate msg.																	
2832 *	3rd line of guest intermediate msg.																	
2932 *	4th line of guest intermediate msg.																	
3032 *	1st line of guest bottom msg.																	
3132 *	2nd line of guest bottom msg.																	
3232 *	3rd line of guest bottom msg.																	
3332 *	4th line of guest bottom msg.																	
3432 *	5th line of guest bottom msg.																	
3532 *	6th line of guest bottom msg.																	
3632 *	7th line of guest bottom msg.																	
3732 *	8th line of guest bottom msg.																	
3832 *	9th line of guest bottom msg.																	
3932 *	10th line of guest bottom msg.																	

* If you want to use these messages, please ask your dealer.

Fix totalizer

Up to 12 characters can be set.

Address code	Contents	Initial character	Address code	Contents	Initial character
Fix totalizer					
0101	Gross sales total	GRSS	5101	Clerk commission 1 total	C-1
0201	Net sales total	NET	5201	Clerk commission 2 total	C-2
0301	Cash in drawer	CAID	5301	Foreign currency cash in drawer 1	CECA1
0401	Cash declared amount	CATL	5401	Foreign currency check in drawer 1	CECK1
0501	Declared short cash amount	CA-	5501	Foreign currency cash in drawer 2	CECA2
0601	Declared over cash amount	CA+	5601	Foreign currency check in drawer 2	CECK2
0701	Charge in drawer	CHID	5701	Foreign currency cash in drawer 3	CECA3
0801	Charge declared amount	CHTL	5801	Foreign currency check in drawer 3	CECK3
0901	Declared short charge amount	CH-	5901	Foreign currency cash in drawer 4	CECA4
1001	Declared over charge amount	CH+	6001	Foreign currency check in drawer 4	CECK4
1101	Check in drawer	CKID	6101	Reduction	DC
1201	Check declared amount	CKTL	6201	Item return	REF
1301	Declared short check amount	CK-	6301	Clear counter	CLEAR
1401	Declared over check amount	CK+	6401	Rounding 2	ROUND
1501	Credit 1 in drawer	CRID(1)	6501	Rounding 1	ROUND
1601	Credit 2 in drawer	CRID(2)	6601	Cancellation	CANCEL
1701	Credit 3 in drawer	CRID(3)	6701	Taxable amount 1	TA1
1801	Credit 4 in drawer	CRID(4)	6801	Tax 1	TX1
1901	Credit declared amount	CRTL	6901	Tax exempt 1	EX1
2001	Declared short credit amount	CR-	7001	Taxable amount 2	TA2
2101	Declared over credit amount	CR+	7101	Tax 2	TX2
2201	Cash in drawer *	CAID2	7201	Tax exempt 2	EX2
2301	Cash declared amount *	CATL2	7301	Taxable amount 3	TA3
2401	Declared short cash amount *	CA- 2	7401	Tax 3	TX3
2501	Declared over cash amount *	CA+ 2	7501	Tax exempt 3	EX3
2601	Charge in drawer *	CHID2	7601	Taxable amount 4	TA4
2701	Charge declared amount *	CHTL2	7701	Tax 4	TX4
2801	Declared short charge amount *	CH- 2	7801	Tax exempt 4	EX4
2901	Declared over charge amount *	CH+ 2	7901	Taxable amount 5	TA5
3001	Check in drawer *	CKID2	8001	Tax 5	TX5
3101	Check declared amount *	CKTL2	8101	Tax exempt 5	EX5
3201	Declared short check amount *	CK- 2	8201	Taxable amount 6	TA6
3301	Declared over check amount *	CK+ 2	8301	Tax 6	TX6
3401	Credit 1 in drawer *	CRID2(1)	8401	Tax exempt 6	EX6
3501	Credit 2 in drawer *	CRID2(2)	8501	Taxable amount 7	TA7
3601	Credit 3 in drawer *	CRID2(3)	8601	Tax 7	TX7
3701	Credit 4 in drawer *	CRID2(4)	8701	Tax exempt 7	EX7
3801	Credit declared amount *	CRTL2	8801	Taxable amount 8	TA8
3901	Declared short credit amount *	CR- 2	8901	Tax 8	TX8
4001	Declared over credit amount *	CR+ 2	9001	Tax exempt 8	EX8
4101-4401	Not used		9101	Taxable amount 9	TA9
4501	Refund mode total	RF	9201	Tax 9	TX9
4601	Customer count	CUST	9301	Tax exempt 9	EX9
4701	Average sales per customer	AVRG	9401	Taxable amount 10	TA10
4801	Check cashing service fee	FEE	9501	Tax 10	TX10
4901	New Balance fee	+	9601	Tax exempt 10	EX10
5001	New balance total	NB	9701	Nontaxable amount	NON TAX

* For sub currencies

Advanced Operations and Setups

Report header

Up to 12 characters can be set.

Address code	Contents	Initial character
Report header		
0124	Fixed totalizer report	FIX
0224	Transaction key report	TRANS
0324	PLU report	PLU
0424	Department report	DEPT
0524	Group report	GROUP
0624	Cashier/clerk report	CASHIER
0724	Not used	
0824	Hourly sales report	HOURLY
0924	Monthly sales report	MONTHLY
1024-1324	Not used	
1424	Hourly item	HOURLY ITEM
1524	Not used	
1624	Financial report	FLASH
1724	Not used	
1824	PLU by amount	PLU AMT
1924	PLU by quantity	PLU QTY
2024	Department by amount	DEPT AMT
2124	Department by quantity	DEPT QTY
2224-2324	Not used	
2424	Individual report	INDIVIDUAL
2524	Not used	

Machine number

Up to 8 characters can be set.

Address code	Contents	Initial character
Machine number		
0191	Machine number	MC#01

Special characters

Address code	Contents	Descriptor
0123	Main currency symbol (2), @(2), No. (2), split pricing (2), Training filler (1), not used(2), Sub currency symbols (2)	@No / ** €
0223	No. of item sold (2), Customer count (2),	NoCT @LB *QT
0323	Multiplication (6), Recalling for a check (6)	X BUSY
0423	Taxable symbol 1 (3 ea.) Tax1, Tax2, Tax3, Tax4, Tax5	T1 T2 T3 T4 T5
0523	Taxable symbol 2 (3 ea.) Tax6, Tax7, Tax8, Tax9, Tax10	T6 T7 T8 T9 T10
0623	Taxable symbol 3 (3 ea.) Tax1/2, Tax1/3, Tax1/4, not used, Tax2/3	T1/2 T1/3 T1/4 T2/3
0723	Taxable symbol 4 (3 ea.) not used, not used, not used, Nontax, All	T T F
0823	Foreign currency (2 ea.)	* * * *
0923	Mode symbol 1 (4 ea.) REG1/2, RF, REG-	REG RFR - MGR
1023	Mode symbol 2 (4 ea.) PGM, Daily X, Daily Z, Periodic	Pn X Z XZ
1123	Mode symbol 3 (4 ea.) Training, not used, PGM read	TRG PGMX
1223	Decimal: amount/q'ty, Separator (Main/Sub) (1 ea.), not used (3), Square (7)	.,,.,, X
1323	A.M., P.M. (3 ea.), ST displayed on the dot display (2)	AM PM ST
1423-1523	(not used)	
1623	(not used)	
1723	Subtotal symbol (16)	ST
1823	Total symbol (16)	TL
1923	Change symbol (16)	CG
2023	Check cashing fee (16)	-
2123	Check cashing amount (16)	CACG
2223	(not used)	
2323	Break (16)	**BREAK END**
2423	Check No. (10)	CHECK No.
2523	Service total (16)	SRVC TL
2623	(not used)	
2723-2823	(not used)	
2923	Report total symbol(16)	TL
3023-3223	(not used)	
3323	Table no. symbol (10)	TABLE No.
3423	(not used)	
3523	Declared amount (16)	DECLA
3623	(not used)	
3723-4123	(not used)	
4223	Designating sub currency (16)	EURO money

Advanced Operations and Setups

Programming department/transaction key descriptor

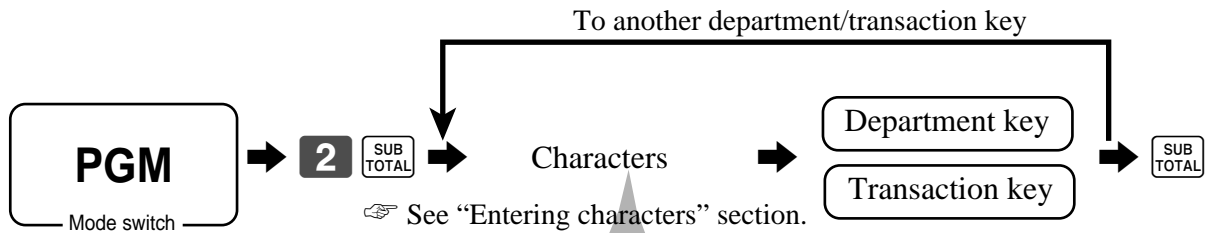

Contents	Initial character	Yours									
Department 01	DEPT01										
Department 02	DEPT02										
Department 03	DEPT03										
Department 04	DEPT04										
Department 05	DEPT05										
Department 06	DEPT06										
Department 07	DEPT07										
Department 08	DEPT08										
Department 09	DEPT09										
Department 10	DEPT10										
Department 11	DEPT11										
Department 12	DEPT12										
Department 13	DEPT13										
Department 14	DEPT14										
Department 15	DEPT15										

Contents	Initial character	Yours									
Cash/Amount tendered	CASH										
Charge	CHARGE										
Credit 1	CREDIT1										
Credit 2	CREDIT2										
Check	CHECK										
Received on account	RC										
Paid out	PD										
Coupon	COUPON										
Minus	-										
Discount	%-										
Refund	RF										
Correction	CORR										
Receipt	RCT										
Non add/No sale	#/NS										
VAT	VAT										
PLU	PLU#										
Price	PRC										
Open	OPEN										
Subtotal	SUBTOTAL										
Receipt on/off	RCT ON/OFF										
Multiplication/Date time	X										
Two zero	00										
Decimal point	.										
Media change	MEDIA CHG										

Programming PLU descriptor

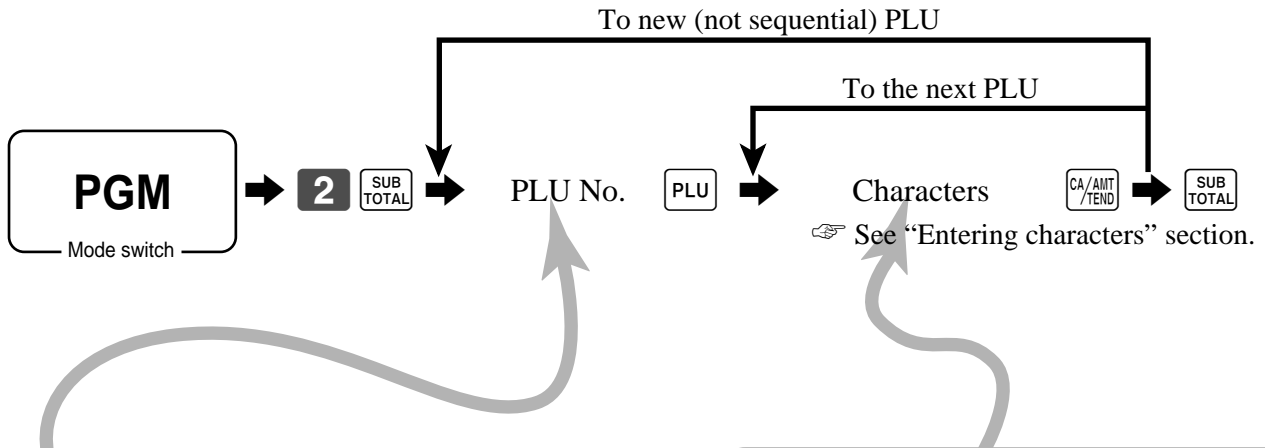

PLU No.	Contents	Initial character	Yours																				
001	PLU 001	PLU0001																					
002	PLU 002	PLU0002																					
003	PLU 003	PLU0003																					
004	PLU 004	PLU0004																					
005	PLU 005	PLU0005																					
006	PLU 006	PLU0006																					
007	PLU 007	PLU0007																					
008	PLU 008	PLU0008																					
009	PLU 009	PLU0009																					
010	PLU 010	PLU0010																					
011	PLU 011	PLU0011																					
012	PLU 012	PLU0012																					
013	PLU 013	PLU0013																					
014	PLU 014	PLU0014																					
015	PLU 015	PLU0015																					
016	PLU 016	PLU0016																					
017	PLU 017	PLU0017																					
018	PLU 018	PLU0018																					
019	PLU 019	PLU0019																					
020	PLU 020	PLU0020																					
021	PLU 021	PLU0021																					
022	PLU 022	PLU0022																					
023	PLU 023	PLU0023																					
024	PLU 024	PLU0024																					
025	PLU 025	PLU0025																					
026	PLU 026	PLU0026																					
027	PLU 027	PLU0027																					
028	PLU 028	PLU0028																					
029	PLU 029	PLU0029																					
098	PLU 098	PLU0098																					
099	PLU 099	PLU0099																					
100	PLU 100	PLU0100																					

Advanced Operations and Setups

Entering characters

In this section, the method to enter descriptors or messages (characters) to the cash register during programming is described.

Characters are specified by character keyboard or by codes. In the first half of this section, the usage of character keyboard is described. In the latter half, inputting method by character code is described.

Using character keyboard

Example:

Input “ **A** p p l e J u i c e ”,
 enter “DBL” “A” “SHIFT” “p” “p” “l” “e” “SPACE” “SHIFT” “SHIFT” “J” “SHIFT” “u” “i” “c” “e” **00** .

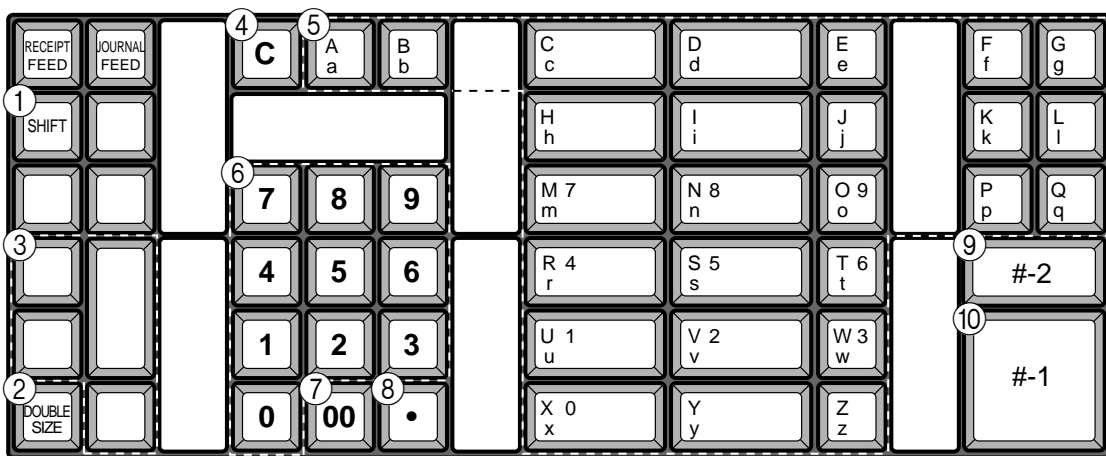

- ① **Shift key**
 Pressing this key shifts the character through the upper-case letter, lower case letter, numerics and returns to the uppercase letter in sequence.
- ② **Double size letter key**
 Specifies that the next character you input to a double size character.
 You must press this key before each double size character.
- ③ **Space key**
 Sets a space by depression.
- ④ **Clear key**
 Clears all input characters in the programming.
- ⑤ **Alphabet keys**
 Used input to characters.
- ⑥ **Numeric keys**
 Used to enter program codes, memory number and character codes.
- ⑦ **Character fixed key**
 Enter when the alphabetic entry for a descriptor, name or message has been completed.
- ⑧ **Backspace/Character code fixed key**
 Registers one character with code (2 or 3 digit).
 Clears the last input character, much like a back space key. (Does not clear the double size letter key entry.)
- ⑨ **Program end key**
 Terminates the character programming.
- ⑩ **Character enter key**
 Registers the programmed characters.

Entering characters by code

Every time you enter a character, choose character codes by the character code list (below) and press the  key to settle it. After you complete entering characters, press the **00** key to fix them.

Example:

Input “ **A** p p l e J u i c e ”,
 enter “ 255  65  112  112  108  101  32  74  117  105  99  101  **00** ”

Character code list

Chara	Code	Chara	Code	Chara	Code	Chara	Code	Chara	Code	Chara	Code	Chara	Code
Space	32	0	48	@	64	P	80	'	96	p	112	Ç	128
!	33	1	49	A	65	Q	81	a	97	q	113	ü	129
"	34	2	50	B	66	R	82	b	98	r	114	é	130
#	35	3	51	C	67	S	83	c	99	s	115	â	131
\$	36	4	52	D	68	T	84	d	100	t	116	ä	132
%	37	5	53	E	69	U	85	e	101	u	117	à	133
&	38	6	54	F	70	V	86	f	102	v	118	å	134
'	39	7	55	G	71	W	87	g	103	w	119	ç	135
(40	8	56	H	72	X	88	h	104	x	120	ê	136
)	41	9	57	I	73	Y	89	i	105	y	121	ë	137
*	42	:	58	J	74	Z	90	j	106	z	122	è	138
+	43	;	59	K	75	[91	k	107	{	123	ï	139
,	44	<	60	L	76	\	92	l	108		124	î	140
-	45	=	61	M	77]	93	m	109	}	125	ì	141
.	46	>	62	N	78	^	94	n	110	~	126	Ä	142
/	47	?	63	O	79	_	95	o	111		127	Å	143
É	144	á	160	■	176	ℓ	192	ð	208	Ó	224	-	240
æ	145	í	161	■	177	±	193	Ð	209	ß	225	±	241
Æ	146	ó	162	■	178	⊥	194	Ê	210	Ô	226	_	242
ô	147	ú	163		179	†	195	Ë	211	Ò	227	3/4	243
ö	148	ñ	164	†	180	—	196	È	212	ö	228	¶	244
ò	149	Ñ	165	Á	181	+	197	€	213	Ö	229	§	245
û	150	ª	166	Â	182	ã	198	Í	214	μ	230	÷	246
ù	151	º	167	À	183	Ã	199	Î	215	þ	231	,	247
ÿ	152	¿	168	©	184	ℓ	200	Ï	216	Þ	232	°	248
Ö	153	®	169	†	185	ƒ	201	⋈	217	Ú	233	”	249
Ü	154	¬	170		186	±	202	ƒ	218	Û	234	•	250
ø	155	1/2	171	⌈	187	⊥	203	■	219	Ù	235	¹	251
£	156	1/4	172	⋈	188	†	204	■	220	ý	236	³	252
∅	157	¡	173	¢	189	—	205		221	Ý	237	²	253
×	158	«	174	¥	190	†	206	ì	222	—	238	■	254
f	159	»	175	ı	191	⌘	207	■	223	'	239	Double size	255

Advanced Operations and Setups

Keyboard layout change

You can change the keyboard layout or allocate some new functions on the keyboard.

Important!

Before changing the keyboard layout, you must issue the daily and all periodic report.

Configuration of the physical key layout

The shadowed keys are fixed function keys. You can not change the function of these keys.

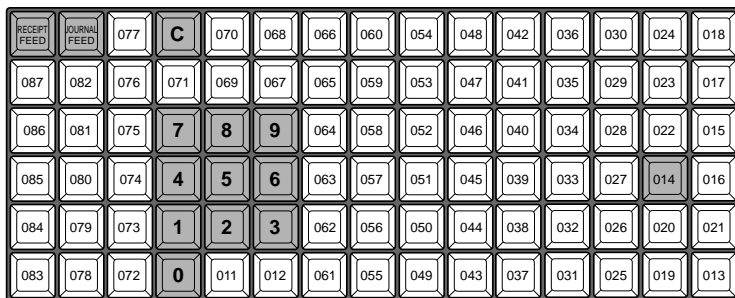

Programming procedure

The shadowed keys are fixed function keys. You can not change the function of these keys.

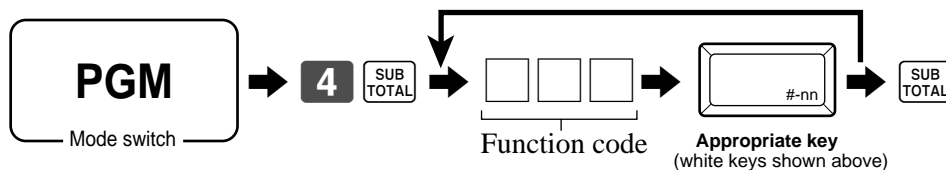

Function code list

Function	Code	Initial character	Function	Code	Initial character
Arrangement	044	ARG	Non-add/No sale	041	#/NS
Bill copy	047	BILL	Open	067	OPEN
Cancel	236	CNCL	Open2	068	OPEN2
Cash amount tendered	001	CASH	Paid out	021	PD
Charge	002	CHARGE	Pick up	022	P.UP
Check tender	003	CHECK	Plus	029	+
Clerk number	072	CLK#	PLU	048	PLU#
Coupon	023	COUPON	Previous balance	026	PB
Coupon 2	036	CPN2	Previous balance subtotal	079	PBST
Credit	004	CREDIT	Premium	030	%+
Cube	090	XXX	Price	049	PRC
Currency exchange	045	CE	Quantity/For	083	QT
Customer number	043	CT	Rate tax	031	TAX
Decimal point *	098	.	Receipt	038	RCT
Declaration	061	DECLARE	Receipt On/Off	076	RCT ON/OFF
Department	nn051	DEPTnn	Received on account	020	RC
Deposit	025	DEPOSIT	Refund	033	RF
Discount	028	%-	Review	071	REVIEW
Eat-in	128	EAT-IN	Square	084	XX
Enter	105	ENTER	Subtotal	075	SUBTOTAL
Error correct	034	CORR	Table number	058	TBL#
Flat PLU	nnnn063	PLUnnnn	Take-out	129	TAKE-OUT
Loan	019	LOAN	Tax exempt	062	EXEMPT
Lock out unused key	000	NOP	Tax status shift	057	T/S
Manual tax	032	TAX	Taxable amount subtotal	077	TAST
Media change	118	MEDIA CHG	Text recall	010	CHAR
Menu shift	064	MENU	Three zero *	097	000
Merchandise subtotal	080	MDST	Tip	015	TIP
Minus	027	-	Tray total	074	TRAY TL
Multiplication	082	X	Two zero *	096	00
New balance	006	NB	VAT	046	VAT
No sale	042	NS	Void	035	VOID
Non-add	040	#			

* Two zero, three zero and decimal point key can only be allocated #011 and #012 position.

The outline of functions

Bill copy

Use this key to issue bill copy.

Cube

This key provides the same functions as the Square key. In addition, this key also has a cube multiplication function.

Customer number

Use this key to register the number of customers.

Declaration

Use this key to declare in drawer amount for money declaration.

Deposit

Use this key to register deposits.

Eat-in

Use this key to specify if the customer eats in the restaurant. Before closing a transaction press this key.

Flat PLU

Use this key to register items to flat PLUs.

Manual tax

Use this key to register a tax amount.

Menu shift

Use this key to shift flat-PLU key to the 1st ~ 6th menu.

Merchandise subtotal

Use this key to obtain subtotal excluding the add-on tax amount and the previous balance.

New balance

Use this key for adding the latest registered total amount to the previous balance to obtain a new balance.

Non add

Use this key to print reference numbers (personal check number, card number, etc.)

Premium

Use this key to apply a preset % or manual input % to obtain the premium amount for the last registered item or subtotal.

Previous balance

Use this key to register the previous negative/positive balance at the beginning of or during a transaction.

Previous balance subtotal

Use this key to obtain subtotal excluding the add-on tax amount and current balance.

Rate tax

Use this key to activate the preset tax rate or manually input rate to obtain the tax for the preceding taxable status 1 amount.

Review

Use this key to examine the current transaction by displaying item descriptor and registered amount. This key is also used for void operation.

Square

This key provides the same functions as the Multiplication key. In addition, this key also has a square multiplication function.

Table number

Use this key to input table numbers.

Takeout

Use this key to specify if the customer takes out items. Before total a transaction. Press this key for the tax exemption.

Tax exempt

Use this key to change taxable amounts to nontaxable amounts.

Taxable amount subtotal

Use this key to obtain taxable amount subtotal.

Text recall

Use this key to print preset characters.

Tip

Use this key to register tips.

Tray total

Use this key to display the total amount for all registrations from the last registration until this key is pressed or registrations between presses of this key.

Void

Use this key to invalidate preceding item data registered.

Advanced Operations and Setups

Printing read/reset reports

- Daily sales read report (“X1” mode)**

You can print read reports at any time during the business day without affecting the data stored in the cash register's memory.

- Daily sales reset report (“Z1” mode)**

You should print reset reports at the end of the business day.

Important!

- The reset operation issues a report and also clears all sales data from the cash register's memory.
- Be sure to perform the reset operations at the end of each business day. Otherwise, you will not be able to distinguish between the sales data for different dates.

To print the individual department, PLU read report

This report shows sales for specific departments or PLUs.

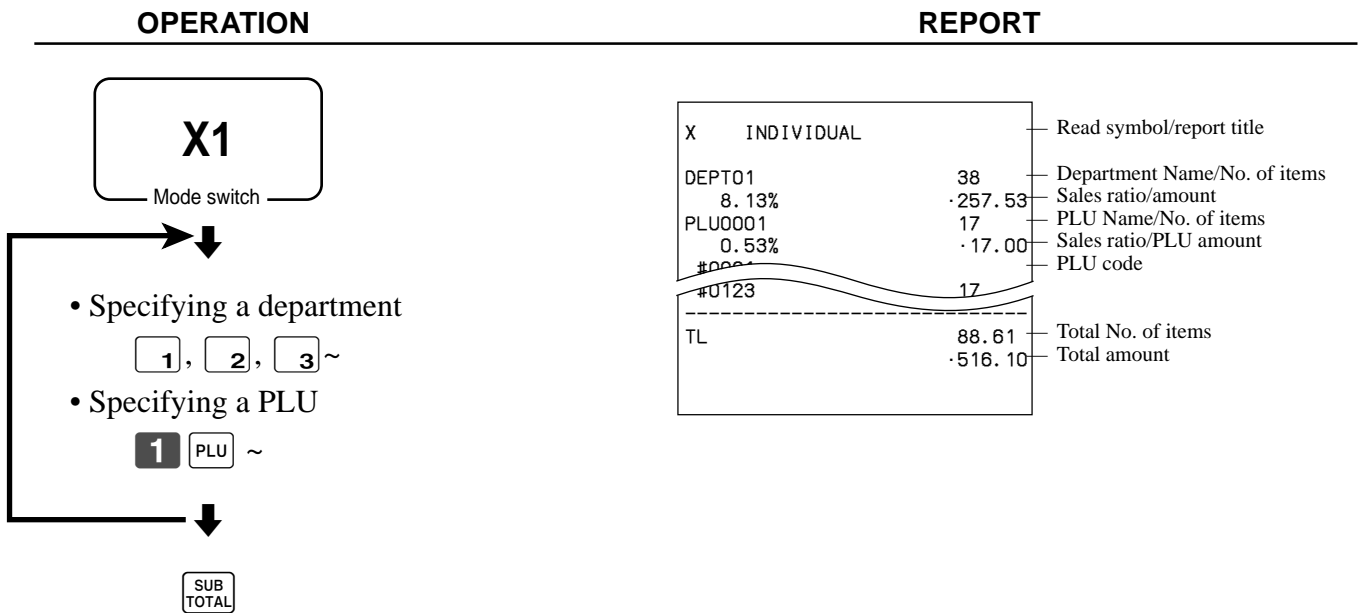

After you finish to select items, press SUB TOTAL to terminate.

To print the financial read report

This report shows gross sales, net sales, cash in drawer and check in drawer.

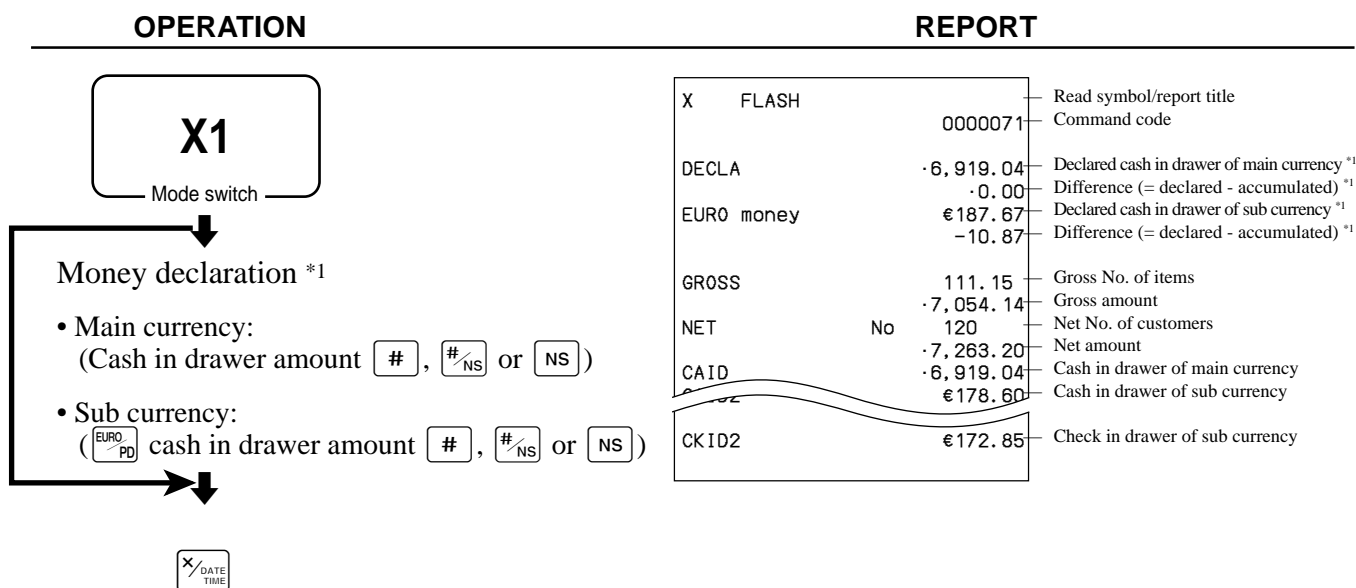

To print the individual clerk read/reset report

This report shows individual clerk totals.

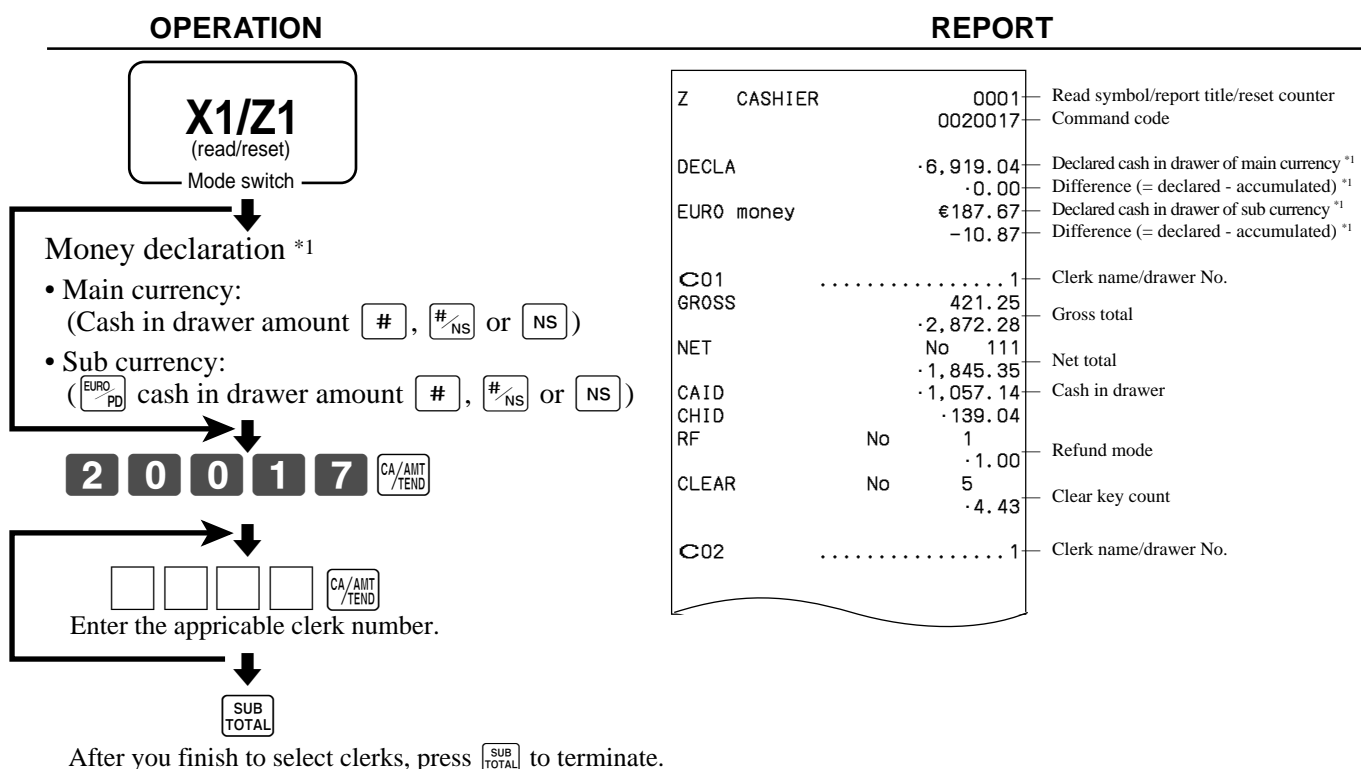

*1 Money declaration:

Count how much cash is in the drawer and input this amount (up to 10 digits).

The cash register will automatically compare the input with the cash in drawer in the memory and print the difference between these two amounts.

Note that if money declaration is required by programming (page 58), you cannot skip this procedure.

Advanced Operations and Setups

To print the daily sales read/reset report

This report shows sales except for PLUs.

OPERATION	REPORT																																																																																																																								
X1/Z1 (read/reset) Mode switch																																																																																																																									
<p>Money declaration *1</p> <ul style="list-style-type: none"> • Main currency: (Cash in drawer amount <input type="text" value="#"/> , <input type="text" value="#/NS"/> or <input type="text" value="NS"/>) • Sub currency: (<input type="text" value="EURO"/> <input type="text" value="PD"/> cash in drawer amount <input type="text" value="#"/> , <input type="text" value="#/NS"/> or <input type="text" value="NS"/>) 																																																																																																																									
CA / AMT / TEND																																																																																																																									
<table style="width: 100%; border-collapse: collapse;"> <tr><td colspan="3">-----</td></tr> <tr><td>Z</td><td>BATCH 01</td><td>Report title</td></tr> <tr><td colspan="3">-----</td></tr> <tr><td>Z</td><td>FIX</td><td>0001 Fixed total report title/reset counter *4</td></tr> <tr><td></td><td></td><td>0001011 Report code</td></tr> <tr><td colspan="3">-----</td></tr> <tr><td>DECLA</td><td></td><td>·6,919.04 Declared cash in drawer of main currency *1</td></tr> <tr><td></td><td></td><td>·0.00 Difference (= declared - accumulated) *1</td></tr> <tr><td>EURO money</td><td></td><td>€187.67 Declared cash in drawer of sub currency *1</td></tr> <tr><td></td><td></td><td>-10.87 Difference (= declared - accumulated) *1</td></tr> <tr><td colspan="3">-----</td></tr> <tr><td>GROSS</td><td></td><td>981.25 Gross total *3</td></tr> <tr><td></td><td></td><td>·6,574.40</td></tr> <tr><td>NET</td><td>No</td><td>111 Net total *3</td></tr> <tr><td></td><td></td><td>·7,057.14</td></tr> <tr><td>CAID</td><td></td><td>·6,919.04 Cash in drawer *3</td></tr> <tr><td>CHID</td><td></td><td>·139.04 Charge in drawer *3</td></tr> <tr><td>CKID</td><td></td><td>·859.85 Check in drawer *3</td></tr> <tr><td>CRID(1)</td><td></td><td>·709.85 Credit in drawer *3</td></tr> <tr><td colspan="3">-----</td></tr> <tr><td>RF</td><td>No</td><td>3 Refund mode *3</td></tr> <tr><td></td><td></td><td>·10.22</td></tr> <tr><td>CUST</td><td>CT</td><td>111 Customer number *3</td></tr> <tr><td>AVRG</td><td></td><td>·63.57 Average sales per customer *3</td></tr> <tr><td>DC</td><td></td><td>·1.22 Discount total *3</td></tr> <tr><td>REF</td><td></td><td>·2.42 Refund key *3</td></tr> <tr><td>CLEAR</td><td>No</td><td>85 Clear key count *3</td></tr> <tr><td>ROUND</td><td></td><td>·0.00 Rounding total *3</td></tr> <tr><td>CANCEL</td><td>No</td><td>2 Cancellation *3</td></tr> <tr><td></td><td></td><td>·12.97</td></tr> <tr><td colspan="3">-----</td></tr> <tr><td>TA1</td><td></td><td>·2,369.69 Taxable 1 amount *3</td></tr> <tr><td>TX1</td><td></td><td>·128.86 Tax 1 amount *3</td></tr> <tr><td>TA2</td><td></td><td>·2,172.96 Taxable 2 amount *3</td></tr> <tr><td>TX2</td><td></td><td>·217.33 Tax 2 amount *3</td></tr> <tr><td colspan="3">-----</td></tr> <tr><td>GT1</td><td></td><td>·00000000125478.96 Grand total 1 *3</td></tr> <tr><td>GT2</td><td></td><td>·00000000346284.23 Grand total 2 *3</td></tr> <tr><td>GT3</td><td></td><td>·00000000123212.75 Grand total 3 *3</td></tr> <tr><td colspan="3">-----</td></tr> </table>	-----			Z	BATCH 01	Report title	-----			Z	FIX	0001 Fixed total report title/reset counter *4			0001011 Report code	-----			DECLA		·6,919.04 Declared cash in drawer of main currency *1			·0.00 Difference (= declared - accumulated) *1	EURO money		€187.67 Declared cash in drawer of sub currency *1			-10.87 Difference (= declared - accumulated) *1	-----			GROSS		981.25 Gross total *3			·6,574.40	NET	No	111 Net total *3			·7,057.14	CAID		·6,919.04 Cash in drawer *3	CHID		·139.04 Charge in drawer *3	CKID		·859.85 Check in drawer *3	CRID(1)		·709.85 Credit in drawer *3	-----			RF	No	3 Refund mode *3			·10.22	CUST	CT	111 Customer number *3	AVRG		·63.57 Average sales per customer *3	DC		·1.22 Discount total *3	REF		·2.42 Refund key *3	CLEAR	No	85 Clear key count *3	ROUND		·0.00 Rounding total *3	CANCEL	No	2 Cancellation *3			·12.97	-----			TA1		·2,369.69 Taxable 1 amount *3	TX1		·128.86 Tax 1 amount *3	TA2		·2,172.96 Taxable 2 amount *3	TX2		·217.33 Tax 2 amount *3	-----			GT1		·00000000125478.96 Grand total 1 *3	GT2		·00000000346284.23 Grand total 2 *3	GT3		·00000000123212.75 Grand total 3 *3	-----			

Z	BATCH 01	Report title																																																																																																																							

Z	FIX	0001 Fixed total report title/reset counter *4																																																																																																																							
		0001011 Report code																																																																																																																							

DECLA		·6,919.04 Declared cash in drawer of main currency *1																																																																																																																							
		·0.00 Difference (= declared - accumulated) *1																																																																																																																							
EURO money		€187.67 Declared cash in drawer of sub currency *1																																																																																																																							
		-10.87 Difference (= declared - accumulated) *1																																																																																																																							

GROSS		981.25 Gross total *3																																																																																																																							
		·6,574.40																																																																																																																							
NET	No	111 Net total *3																																																																																																																							
		·7,057.14																																																																																																																							
CAID		·6,919.04 Cash in drawer *3																																																																																																																							
CHID		·139.04 Charge in drawer *3																																																																																																																							
CKID		·859.85 Check in drawer *3																																																																																																																							
CRID(1)		·709.85 Credit in drawer *3																																																																																																																							

RF	No	3 Refund mode *3																																																																																																																							
		·10.22																																																																																																																							
CUST	CT	111 Customer number *3																																																																																																																							
AVRG		·63.57 Average sales per customer *3																																																																																																																							
DC		·1.22 Discount total *3																																																																																																																							
REF		·2.42 Refund key *3																																																																																																																							
CLEAR	No	85 Clear key count *3																																																																																																																							
ROUND		·0.00 Rounding total *3																																																																																																																							
CANCEL	No	2 Cancellation *3																																																																																																																							
		·12.97																																																																																																																							

TA1		·2,369.69 Taxable 1 amount *3																																																																																																																							
TX1		·128.86 Tax 1 amount *3																																																																																																																							
TA2		·2,172.96 Taxable 2 amount *3																																																																																																																							
TX2		·217.33 Tax 2 amount *3																																																																																																																							

GT1		·00000000125478.96 Grand total 1 *3																																																																																																																							
GT2		·00000000346284.23 Grand total 2 *3																																																																																																																							
GT3		·00000000123212.75 Grand total 3 *3																																																																																																																							

Z	TRANS		0001	Function key report title/reset counter *4
			0001012	Report code
CASH	No	362		Function key count/amount *2
		· 1,638.04		
CHARGE	No	56		
		· 1,174.85		
RC	No	4		
		· 810.00		
PD	No	5		
		· 520.00		
		· 0.00		
CORR	No	14		
		· 39.55		
RCT	No	3		
NS	No	5		
Z	DEPT		0001	Department report title/reset counter *4
			0001015	Report code
DEPT01		38		Department name/No. of items *2
8.13%		· 257.53		Sales ratio/amount *2
DEPT02		183		
		· 1,260.00		
		· 0.00		
TL		88.61		Total No. of items
		· 1,916.10		Total amount
Z	CASHIER		0001	Clerk report title/reset counter *4
			0001017	Report code
C01	1		Clerk name/drawer No.
GROSS		421.25		Gross total
		· 2,872.28		
NET	No	111		Net total
		· 1,845.35		
CAID		· 1,057.14		Cash in drawer
CHID		· 139.04		
RF	No	1		Refund mode
		· 1.00		
CLEAR	No	5		Clear key count
		· 4.43		
C02	1		Clerk name/drawer No.

*1 Money declaration:

Count how much cash is in the drawer and input this amount (up to 10 digits).

The cash register will automatically compare the input with the cash in drawer in the memory and print the difference between these two amounts.

Note that if money declaration is required by programming (page 58), you cannot skip this procedure.

*2 Zero totalled departments/functions (the amount and item numbers are both zero) are not printed.

*3 These items can be skipped by programming.

4 The “” symbol is printed on the reset report, memory overflow occurred in the counter/totalizer.

Advanced Operations and Setups

To print the PLU read/reset report

This report shows sales for PLUs.

OPERATION	REPORT																																																						
<div style="border: 1px solid black; padding: 5px; width: fit-content; margin: 0 auto;"> <p>X1/Z1 (read/reset) Mode switch</p> </div> <p style="text-align: center;">↓</p> <div style="display: flex; justify-content: center; gap: 10px;"> <div style="border: 1px solid black; padding: 2px 10px; font-weight: bold;">0</div> <div style="border: 1px solid black; padding: 2px 10px; font-weight: bold;">1</div> <div style="border: 1px solid black; padding: 2px 10px; font-weight: bold;">4</div> <div style="border: 1px solid black; padding: 2px 10px; font-size: 8px;">CA/AMT /TEND</div> </div>	<table border="1" style="width: 100%; border-collapse: collapse;"> <tr> <td style="width: 10%;">X</td> <td style="width: 40%;">PLU</td> <td style="width: 10%;"></td> <td style="width: 10%;"></td> <td style="width: 20%;">0000014</td> <td style="font-size: 8px;">Read symbol/report title Report code</td> </tr> <tr> <td></td> <td>PLU0001</td> <td></td> <td>17</td> <td></td> <td>PLU name/No. of items</td> </tr> <tr> <td></td> <td>0.53%</td> <td></td> <td>17.00</td> <td></td> <td>Sales ratio/PLU amount</td> </tr> <tr> <td></td> <td>#0001</td> <td></td> <td>42</td> <td></td> <td>PLU code</td> </tr> <tr> <td></td> <td>4.03%</td> <td></td> <td></td> <td></td> <td></td> </tr> <tr> <td></td> <td>#0100</td> <td></td> <td></td> <td></td> <td></td> </tr> <tr> <td colspan="5" style="border-top: 1px dashed black;"></td> <td></td> </tr> <tr> <td></td> <td>TL</td> <td></td> <td>188.61</td> <td></td> <td>Total No. of items</td> </tr> <tr> <td></td> <td></td> <td></td> <td>516.10</td> <td></td> <td>Total amount</td> </tr> </table>	X	PLU			0000014	Read symbol/report title Report code		PLU0001		17		PLU name/No. of items		0.53%		17.00		Sales ratio/PLU amount		#0001		42		PLU code		4.03%						#0100												TL		188.61		Total No. of items				516.10		Total amount
X	PLU			0000014	Read symbol/report title Report code																																																		
	PLU0001		17		PLU name/No. of items																																																		
	0.53%		17.00		Sales ratio/PLU amount																																																		
	#0001		42		PLU code																																																		
	4.03%																																																						
	#0100																																																						
	TL		188.61		Total No. of items																																																		
			516.10		Total amount																																																		

To print the hourly sales read/reset report

This report shows hourly breakdowns of sales.

OPERATION	REPORT																																																																																				
<div style="border: 1px solid black; padding: 5px; width: fit-content; margin: 0 auto;"> <p>X1/Z1 (read/reset) Mode switch</p> </div> <p style="text-align: center;">↓</p> <div style="display: flex; justify-content: center; gap: 10px;"> <div style="border: 1px solid black; padding: 2px 10px; font-weight: bold;">0</div> <div style="border: 1px solid black; padding: 2px 10px; font-weight: bold;">1</div> <div style="border: 1px solid black; padding: 2px 10px; font-weight: bold;">9</div> <div style="border: 1px solid black; padding: 2px 10px; font-size: 8px;">CA/AMT /TEND</div> </div>	<table border="1" style="width: 100%; border-collapse: collapse;"> <tr> <td style="width: 10%;">X</td> <td style="width: 40%;">HOURLY</td> <td style="width: 10%;"></td> <td style="width: 10%;"></td> <td style="width: 20%;">0000019</td> <td style="font-size: 8px;">Read symbol/report title Report code</td> </tr> <tr> <td></td> <td>00:00->01:00</td> <td></td> <td></td> <td></td> <td>Time range</td> </tr> <tr> <td></td> <td></td> <td>CT</td> <td>1</td> <td></td> <td>No. of customers</td> </tr> <tr> <td></td> <td>GROSS</td> <td></td> <td>1.10</td> <td></td> <td>Gross sales amount</td> </tr> <tr> <td></td> <td>NET</td> <td>No</td> <td>1.20</td> <td></td> <td>No. of receipt</td> </tr> <tr> <td></td> <td>1.90%</td> <td></td> <td></td> <td></td> <td>Sales ratio/net sales amount</td> </tr> <tr> <td></td> <td>GROSS</td> <td></td> <td>3.45</td> <td></td> <td></td> </tr> <tr> <td></td> <td>NET</td> <td>No</td> <td>3.59</td> <td></td> <td></td> </tr> <tr> <td></td> <td>3.90%</td> <td></td> <td></td> <td></td> <td></td> </tr> <tr> <td colspan="5" style="border-top: 1px dashed black;"></td> <td></td> </tr> <tr> <td></td> <td>TL</td> <td>CT</td> <td>280</td> <td></td> <td>Total No. of customers</td> </tr> <tr> <td></td> <td>GROSS</td> <td></td> <td>1,937.61</td> <td></td> <td>Gross total amount</td> </tr> <tr> <td></td> <td>NET</td> <td>No</td> <td>25</td> <td></td> <td>Total No. of receipt</td> </tr> <tr> <td></td> <td></td> <td></td> <td>2,096.80</td> <td></td> <td>Net total amount</td> </tr> </table>	X	HOURLY			0000019	Read symbol/report title Report code		00:00->01:00				Time range			CT	1		No. of customers		GROSS		1.10		Gross sales amount		NET	No	1.20		No. of receipt		1.90%				Sales ratio/net sales amount		GROSS		3.45				NET	No	3.59				3.90%												TL	CT	280		Total No. of customers		GROSS		1,937.61		Gross total amount		NET	No	25		Total No. of receipt				2,096.80		Net total amount
X	HOURLY			0000019	Read symbol/report title Report code																																																																																
	00:00->01:00				Time range																																																																																
		CT	1		No. of customers																																																																																
	GROSS		1.10		Gross sales amount																																																																																
	NET	No	1.20		No. of receipt																																																																																
	1.90%				Sales ratio/net sales amount																																																																																
	GROSS		3.45																																																																																		
	NET	No	3.59																																																																																		
	3.90%																																																																																				
	TL	CT	280		Total No. of customers																																																																																
	GROSS		1,937.61		Gross total amount																																																																																
	NET	No	25		Total No. of receipt																																																																																
			2,096.80		Net total amount																																																																																

To print the monthly sales read/reset report

This report shows monthly breakdowns of sales.

OPERATION	REPORT																																																																												
<div style="border: 1px solid black; padding: 5px; width: fit-content; margin: 0 auto;"> <p>X1/Z1 (read/reset) Mode switch</p> </div> <p style="text-align: center;">↓</p> <div style="display: flex; justify-content: center; gap: 10px; align-items: center;"> <div style="border: 1px solid black; padding: 2px 5px; font-weight: bold;">0</div> <div style="border: 1px solid black; padding: 2px 5px; font-weight: bold;">2</div> <div style="border: 1px solid black; padding: 2px 5px; font-weight: bold;">0</div> <div style="border: 1px solid black; padding: 2px 5px; font-size: 8px;">CA/AMT /TEND</div> </div>	<table border="0" style="width: 100%; border-collapse: collapse;"> <tr> <td style="width: 15%;">X</td> <td style="width: 45%;">MONTHLY</td> <td style="width: 20%;">0000020</td> <td style="width: 20%; vertical-align: top;">Read symbol/report title Report code</td> </tr> <tr> <td></td> <td>1.....</td> <td></td> <td>Date of a month</td> </tr> <tr> <td>GROSS</td> <td></td> <td>1236.76</td> <td>Gross symbol/No. of items</td> </tr> <tr> <td></td> <td></td> <td>· 12,202.57</td> <td>Gross sales amount</td> </tr> <tr> <td>NET</td> <td>No</td> <td>214</td> <td>Net symbol/No. of customers</td> </tr> <tr> <td></td> <td></td> <td>· 12,202.57</td> <td>Net sales amount</td> </tr> <tr> <td colspan="4" style="text-align: center;">-----</td> </tr> <tr> <td>GROSS</td> <td></td> <td>2102</td> <td></td> </tr> <tr> <td></td> <td></td> <td>· 14,187.57</td> <td></td> </tr> <tr> <td>NET</td> <td>No</td> <td>205</td> <td></td> </tr> <tr> <td></td> <td></td> <td>· 13,398.76</td> <td></td> </tr> <tr> <td colspan="4" style="text-align: center;">-----</td> </tr> <tr> <td>TL</td> <td></td> <td></td> <td>Total symbol</td> </tr> <tr> <td>GROSS</td> <td></td> <td>9746.63</td> <td>Gross symbol/No. of items</td> </tr> <tr> <td></td> <td></td> <td>· 161,022.49</td> <td>Gross sales amount</td> </tr> <tr> <td></td> <td></td> <td>· 16.52</td> <td>Average daily gross sales</td> </tr> <tr> <td>NET</td> <td>No</td> <td>2351</td> <td>Net symbol/No. of customers</td> </tr> <tr> <td></td> <td></td> <td>· 161,022.49</td> <td>Net sales amount</td> </tr> <tr> <td></td> <td></td> <td>· 68.49</td> <td>Average daily net sales</td> </tr> </table>	X	MONTHLY	0000020	Read symbol/report title Report code		1.....		Date of a month	GROSS		1236.76	Gross symbol/No. of items			· 12,202.57	Gross sales amount	NET	No	214	Net symbol/No. of customers			· 12,202.57	Net sales amount	-----				GROSS		2102				· 14,187.57		NET	No	205				· 13,398.76		-----				TL			Total symbol	GROSS		9746.63	Gross symbol/No. of items			· 161,022.49	Gross sales amount			· 16.52	Average daily gross sales	NET	No	2351	Net symbol/No. of customers			· 161,022.49	Net sales amount			· 68.49	Average daily net sales
X	MONTHLY	0000020	Read symbol/report title Report code																																																																										
	1.....		Date of a month																																																																										
GROSS		1236.76	Gross symbol/No. of items																																																																										
		· 12,202.57	Gross sales amount																																																																										
NET	No	214	Net symbol/No. of customers																																																																										
		· 12,202.57	Net sales amount																																																																										

GROSS		2102																																																																											
		· 14,187.57																																																																											
NET	No	205																																																																											
		· 13,398.76																																																																											

TL			Total symbol																																																																										
GROSS		9746.63	Gross symbol/No. of items																																																																										
		· 161,022.49	Gross sales amount																																																																										
		· 16.52	Average daily gross sales																																																																										
NET	No	2351	Net symbol/No. of customers																																																																										
		· 161,022.49	Net sales amount																																																																										
		· 68.49	Average daily net sales																																																																										

To print the group read/reset report

This report shows PLU/department group totals.

OPERATION	REPORT																																																				
<div style="border: 1px solid black; padding: 5px; width: fit-content; margin: 0 auto;"> <p>X1/Z1 (read/reset) Mode switch</p> </div> <p style="text-align: center;">↓</p> <div style="display: flex; justify-content: center; gap: 10px; align-items: center;"> <div style="border: 1px solid black; padding: 2px 5px; font-weight: bold;">0</div> <div style="border: 1px solid black; padding: 2px 5px; font-weight: bold;">1</div> <div style="border: 1px solid black; padding: 2px 5px; font-weight: bold;">6</div> <div style="border: 1px solid black; padding: 2px 5px; font-size: 8px;">CA/AMT /TEND</div> </div>	<table border="0" style="width: 100%; border-collapse: collapse;"> <tr> <td style="width: 15%;">X</td> <td style="width: 45%;">GROUP</td> <td style="width: 20%;">0000016</td> <td style="width: 20%; vertical-align: top;">Read symbol/report title Report code</td> </tr> <tr> <td>GROUP01</td> <td></td> <td>203.25</td> <td>Group No./No. of items</td> </tr> <tr> <td></td> <td>33.87%</td> <td>· 1,108.54</td> <td>Sales ratio/group amount</td> </tr> <tr> <td>GROUP02</td> <td></td> <td>183</td> <td></td> </tr> <tr> <td></td> <td>40.58%</td> <td>· 1,327.80</td> <td></td> </tr> <tr> <td>GROUP03</td> <td></td> <td>12</td> <td></td> </tr> <tr> <td></td> <td>0.46%</td> <td>· 13.25</td> <td></td> </tr> <tr> <td colspan="4" style="text-align: center;">-----</td> </tr> <tr> <td>GROUP99</td> <td></td> <td>13</td> <td></td> </tr> <tr> <td></td> <td>0.54%</td> <td>· 17.80</td> <td></td> </tr> <tr> <td colspan="4" style="text-align: center;">-----</td> </tr> <tr> <td>TL</td> <td></td> <td>862</td> <td>Group total No. of items</td> </tr> <tr> <td></td> <td></td> <td>· 3,272.00</td> <td>Group total amount</td> </tr> </table>	X	GROUP	0000016	Read symbol/report title Report code	GROUP01		203.25	Group No./No. of items		33.87%	· 1,108.54	Sales ratio/group amount	GROUP02		183			40.58%	· 1,327.80		GROUP03		12			0.46%	· 13.25		-----				GROUP99		13			0.54%	· 17.80		-----				TL		862	Group total No. of items			· 3,272.00	Group total amount
X	GROUP	0000016	Read symbol/report title Report code																																																		
GROUP01		203.25	Group No./No. of items																																																		
	33.87%	· 1,108.54	Sales ratio/group amount																																																		
GROUP02		183																																																			
	40.58%	· 1,327.80																																																			
GROUP03		12																																																			
	0.46%	· 13.25																																																			

GROUP99		13																																																			
	0.54%	· 17.80																																																			

TL		862	Group total No. of items																																																		
		· 3,272.00	Group total amount																																																		

Advanced Operations and Setups

- Periodic sales read report (“X2” mode)**

You can print read reports at any time during the business day without affecting the data stored in the cash register's memory.

- Periodic sales reset report (“Z2” mode)**

You should print reset reports at the end of the business day.

To print the periodic 1/2 sales read/reset reports

These reports show sales breakdowns of sales by any two kinds of period you want.

OPERATION

REPORT

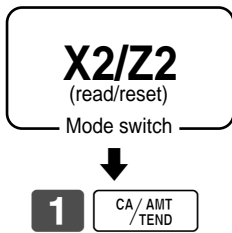

ZZ1	BATCH02			Report title

ZZ1	FIX		0001	Fixed total report title/reset counter
			0001111	Report code
GROSS			981.25	Gross total *2
			-6,574.40	
NET	No		111	Net total *2
			-7,057.14	
CAID			-6,919.04	Cash in drawer *2
CHID			-139.04	Charge in drawer *2
CKID			-859.85	Check in drawer *2
CRID(1)			-709.85	Credit in drawer *2

RF	No		3	Refund mode *2
			-10.22	
CUST	CT		111	Customer number *2
AVRG			-63.57	Average sales per customer *2
DC			-1.22	Discount total *2
REF			-2.42	Refund key *2
CLEAR	No		85	Clear key count *2
ROUND			-0.00	Rounding total *2
CANCEL	No		2	Cancellation *2
			-12.97	

TA1			-2,369.69	Taxable 1 amount *2
TX1			-128.86	Tax 1 amount *2
TA2			-2,172.96	Taxable 2 amount *2
TX2			-217.33	Tax 2 amount *2

ZZ1	TRANS		0001	Function key report title/reset counter
			0001112	Report code
CASH	No		362	Function key count/amount *1
			-1,638.04	
CHARGE	No		56	
			-1,174.85	
RC	No		4	
			-810.00	
PD	No		5	
			-5.00	
CPD	No		14	
			20	

RCT	No		3	
NS	No		5	

ZZ1 DEPT		0001		Department report title/reset counter
		0001115		Report code
DEPT01		38		Department Name/No. of items *1
8.13%		.257.53		Sales ratio/amount
DEPT02		183		
		.1.362.0		

TL		88.61		Total No. of items
		-1,916.10		Total amount

ZZ1 CASHIER		0001		Clerk report title/reset counter
		0001117		Report code
C01	1		Clerk name/drawer No.
GROSS		421.25		Gross total
		-2,872.28		
NET	No	111		Net total
		-1,845.35		
CAID		-1,057.14		Cash in drawer
CHID		.139.04		
RF	No	1		Refund mode
		-1.00		
CLEAR	No	5		Clear key count
		-4.43		
C02	1		Clerk name/drawer No.

*1 Zero totalled departments/functions (the amount and item numbers are both zero) are not printed.

*2 These items can be skipped by programming.

Advanced Operations and Setups

Reading the cash register's program

To print unit price/rate program (except PLU)

OPERATION

PGM

Mode switch



1 SUB
TOTAL



SUB
TOTAL

REPORT

P01.....			Program read symbol
CASH		@100.00	Transaction key unit price or rate
CHECK		@1.00	
-		@1.00	
%		10%	
DEPT01		0001-05	Department descriptor/rec-#/file-#
	1.2	@1.00	Unit quantity/unit price
DEPT02		0002-05	
	1	@2.00	

To print key descriptor, name, message program (except PLU)

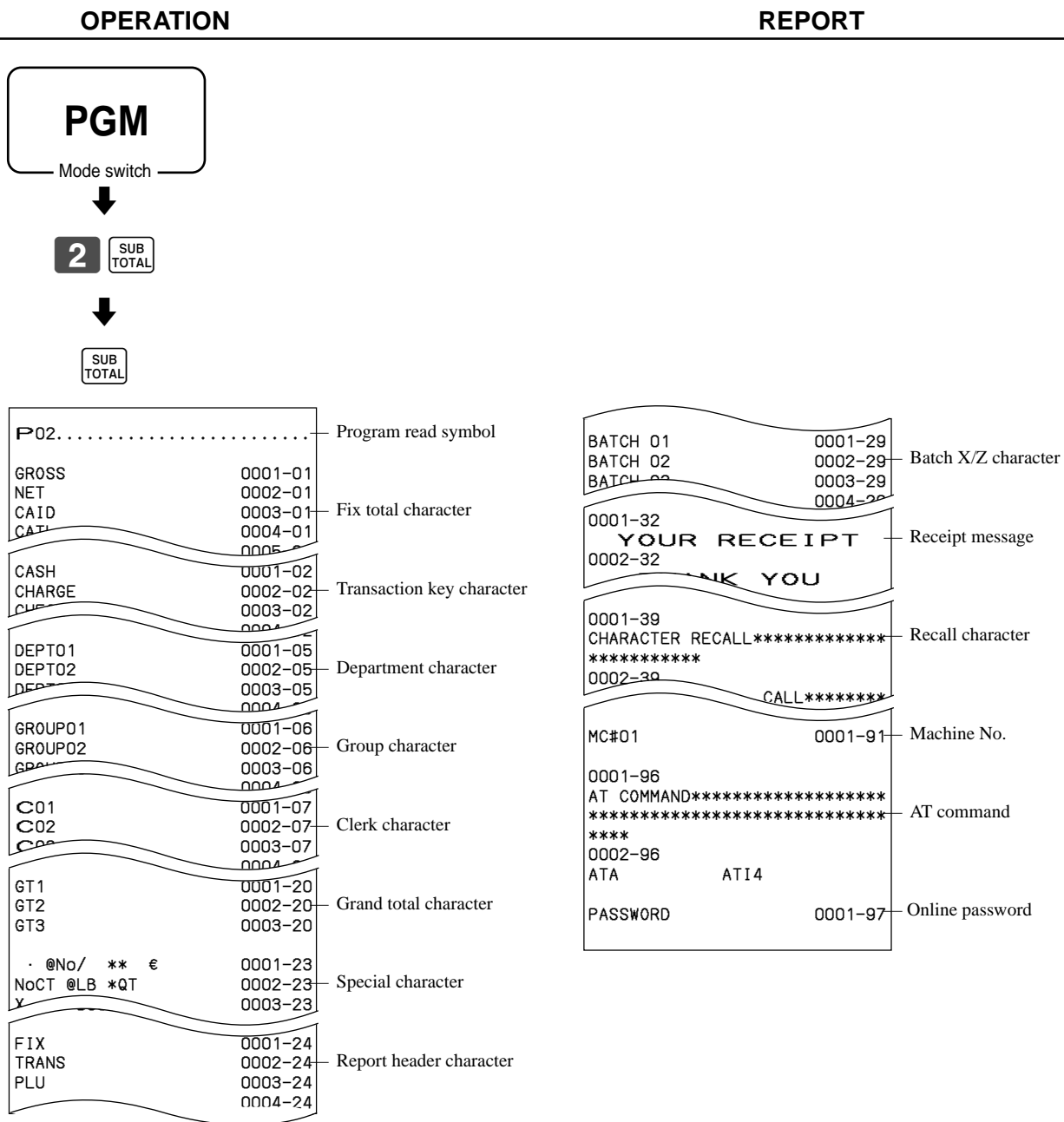

Advanced Operations and Setups

To print the general control program, compulsory and key program

OPERATION

REPORT

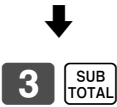
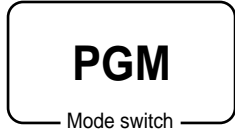

P03.....		Program read symbol
CASH	0001-02	
	00000000000000	Transaction key program
CHECK	0002-02	Key character/rec-#/file-#
	00000000000000	Key program
CREDIT2	0003-02	
	00000002000002	
DEPT01	0001-05	Department program
	00000000000000	Key character/rec-#/file-#
11-66	000000	Key program
15-66	@1. 23	Batch program 1166
DEPT01	0002-05	Batch program 1566
C01	0001-07	Clerk program
	000001000001	Clerk name/rec-#/file-#
67	0000000000	Clerk #/drw-#/secret-#
68	0000000000	Compulsory
70	0000000000	Commission rate
	0000000000	Not used
	0002-07	
0001-09	00:00 -> 01:00	Time range program
0002-09	01:00 -> 02:00	
0003-09	02:00 -> 03:00	
0001-22	2200000000	General control program
0002-22	0000000000	
0003-22	0000000000	
0001-25		Tax table
TX1	10.25%	
TX1	0000	
TX1	5003	
BATCH01	0001-29	
00	11-12-17-15-00	Batch X/Z program
	00-00-00-00-00	
BATCH02	0002-29	
01	11-12-17-15-00	
	00-00-00-00-00	
0001-30		Clerk detail link program
GROSS	0001-01	
0002-30		
NET	0002-01	

0001-38	012345	Arrangement program
REG1	204-000	Rec-#/file-#/arrange no.
1	001-000	Key descriptor/rec-#/file-#
2	002-000	
DEPT01	026-051	
CASH	013-001	
0001-62	000000	Scheduler program
	00000000000000	
	00000000000000	
0002-62	000000	
	00000000000000	
MC#01	0001-91	Terminal connection table
	0000	
0001-98	00000000000000	I/O parameter table

To print the keyboard layout program

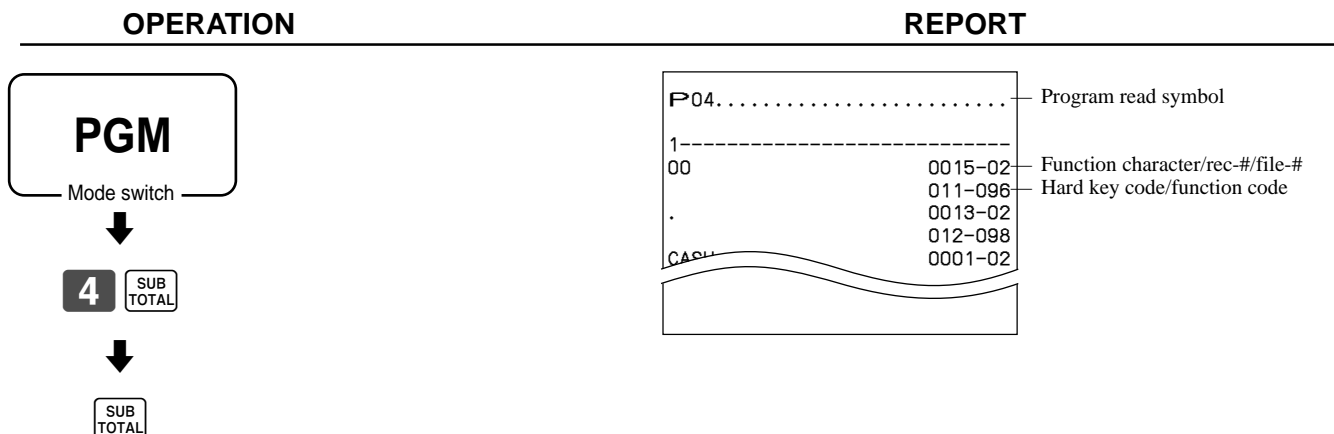

To print the PLU program

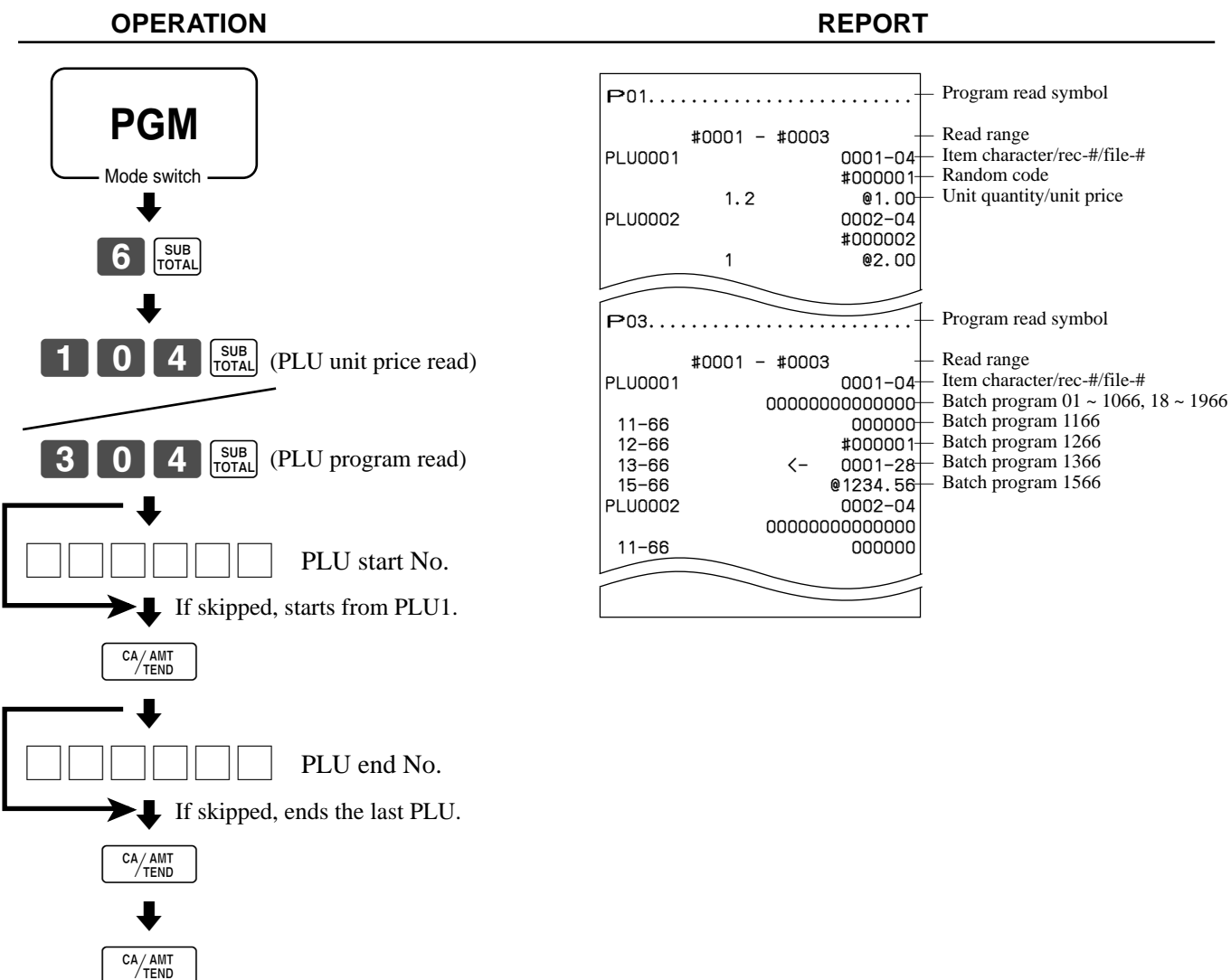

Troubleshooting

This section describes what to do when you have problems with operation.

When an error occurs

Errors are indicated by an error codes. When this happens, you can usually find out what the problem is as shown below.

Error code	Meaning	Action
E001	Mode switch position changed before finalization.	Return the mode switch to its original setting and finalize the operation.
E003	Clerk button pressed before finalization of a registration being performed under another clerk button. The signed on clerk differs from the clerk performed the clerk interrupt registration.	Press the original clerk button and finalize the transaction before pressing another clerk button. Assign the proper clerk number.
E004	Initialization or unit lock clear operation in progress.	Complete operation.
E008	Registration without entering a clerk number.	Enter a clerk number.
E009	Operation without entering the password.	Enter password.
E010	Registration is made while the cash drawer is opened. The drawer is left open longer than the program time (drawer open alarm).	Close the drawer.
E011	Attempt to register while the cash drawer is open.	Shut the cash drawer.
E015	Printer error Paper jam Printer head is released.	Remove jammed paper. Lock the printer head.
E016	Two consecutive transactions attempted in the refund mode.	Switch to another mode and then back to the RF mode for the next transaction.
E018	Attempt made to register an item without inputting a table number.	Input a table number.
E019	Finalize operation attempted without entering the number of customer.	Enter the number of customer.
E021	No department linked PLU is registered.	Correct the program.
E026	No condiment/preparation PLU is registered.	Register condiment/preparation PLU.
E029	Item registration is prohibited, while partial tender.	Finalize the transaction.
E030	Attempt made to finalize the transaction without registering rate-tax.	Register <RATE TAX>.
E031	Finalization of a transaction attempted without confirming the subtotal.	Press <SUBTOTAL>.
E033	Finalize operation attempted without entering amount tender.	Enter the amount tendered.
E035	Change amount exceeds preset limit.	Input amount tendered again.
E036	Contents of the drawer exceed programmed limit.	Perform pick up operation.
E037	High amount lock out/low digit lock out error	Enter correct amount.
E038	Read/reset operation without declaring cash in drawer. This error appears only when this function is activated.	Perform money declaration.
E040	Attempt made to finalize a transaction without issuing a guest receipt.	Issue a guest receipt.
E046	Registration buffer full.	Finalize the transaction.
E049	Index memory full.	Finalize and close the check number currently used.
E050	Detail memory full.	Finalize and close the check number currently used.
E059	Register items without specifying <EAT-IN> or <TAKEOUT>.	Press <EAT-IN> or <TAKEOUT>.
E075	Attempt to finalize a transaction when balance is less than or equal to zero.	Register item(s) until the balance becomes positive amount.
E139	Attempt to register <->, <CPN>, or <VOID> when the balance becomes negative.	Enter proper minus/coupon amount.
E146	Arrangement file is full.	Set the arrangement properly.
E153	No random PLU code is set.	Set random PLU code.

When the register does not operate at all

Perform the following check whenever the cash register enter an error condition as soon as you switch it on. The results of this check are required by service personnel, so be sure to perform this check before you contact a CASIO representative for servicing.

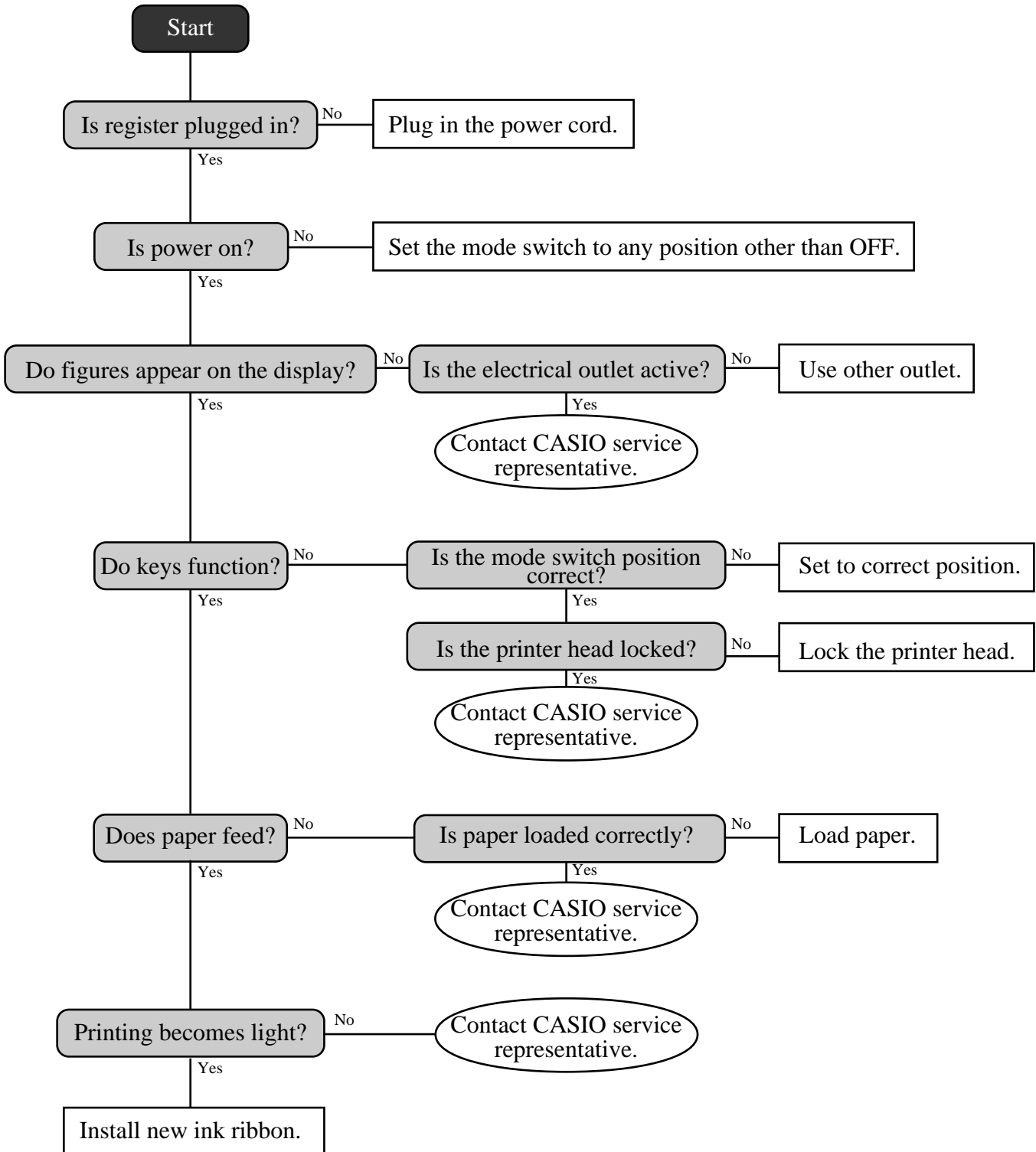

Clearing a machine lock up

If you make a mistake in operation, the cash register may lock up to avoid damage to programs and preset data. Should it happen, you can use the following procedure to clear the lock up without losing any data.

- 1 Power off the register.
- 2 Insert the PGM key in the mode switch.
- 3 Press down **RECEIPT FEED**, and turn the mode switch to PGM mode.
- 4 The display shows ten Fs, then release **RECEIPT FEED**.
- 5 Press **SUB TOTAL**. The display shows ten Fs and issue a receipt.

Important!

If the register does not show ten Fs, never press **SUB TOTAL** and call service representative.

In case of power failure

If the power supply to the cash register is cut by a power failure or any other reason, simply wait for power to be restored. The details of any on-going transaction as well as all sales data in memory are protected by the memory backup batteries.

- Power failure during a registration
The subtotal for items registered up to the power failure is retained in memory. You will be able to continue with the registration when power is restored.
- Power failure during printing a read/reset report
The data already printed before the power failure is retained in memory. After power recovery, the register continues to issue report.
- Power failure during printing of a receipt and the journal
Printing will resume after power is restored. A line that was being printed when the power failure occurred is printed in full.
- Other
The power failure symbol is printed and any item that was being printed when the power failure occurred is reprinted in full.

The memory protection battery is constantly charging and discharging as you switch the cash register on and off during normal operations. This causes the capacity of the battery to decrease after approximately five years of use.

Important !

- Remember... a weak battery has the potential of losing valuable transaction data.
- A label on the back of the cash register shows the normal service period of the battery installed in your cash register.
- Have the battery replaced by your dealer within the period noted on this label.

To replace journal paper

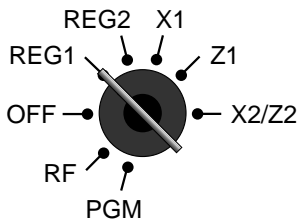

1

Set the mode switch to the REG1 position and remove the printer cover.



2

Press **JOURNAL FEED** to feed about 20 cm of paper.



6

Cut the journal paper as shown in the photograph.



3

Cut the journal paper at the point where nothing is printed.



7

Press **JOURNAL FEED** to feed the remaining paper from the printer.

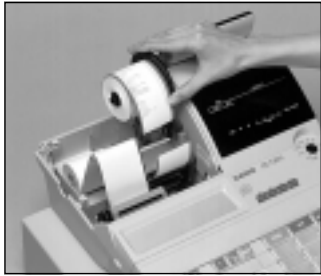

4

Remove the journal take-up reel from its holder.



8

Do not pull the paper out of the printer by hand. It can damage the printer.



5

Slide the printed journal from the take-up reel.



9

Remove the old paper roll from the cash register.

10

Load new paper as described on page 10 of this manual.

User Maintenance and Options

To replace receipt paper

Follow step ① under “To replace journal paper” on the previous page.



②

Cut the receipt paper as shown in the photograph.

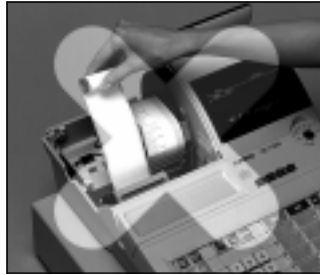

④

Do not pull the paper out of the printer by hand. It can damage the printer.



③

Press **RECEIPT FEED** to feed the remaining paper from the printer.



⑤

Remove the old paper roll from the cash register.

⑥

Load new paper as described on page 11 of this manual.

Options

Wetproof cover: WT-77

Consult with your CASIO dealer for details.

Specifications

Input method

Entry: 10-key system, buffer memory 8 keys (2-key roll over)
 Department: Full key system

Display

Amount 10 digits (zero suppression); department No., PLU No., No. of repeats, total, change, receipt on/off, transaction indicator

Printer

Receipt: Dot matrix alpha-numeric system 31 digits, receipt on/off switch (key)
 Store name or slogan can be printed.
 Journal: Dot matrix alpha-numeric system 31 digits
 Automatic take up roll winding
 Journal paper near end sensor (option)
 Paper roll: 58 (W) × 83 (D) mm
 Paper feed: Separate for receipt and journal
 Print speed: About 15 l/s

Listing capacity

Amount: 99999999
 Quantity: 9999,999
 Tended amount: 9999999999
 Percent: 99.99
 Tax rate: 9999.9999
 Numbers: 9999999999999999

Chronological data

Date print: Automatic date printout on receipt or journal, automatic calendar
 Time print: Automatic time printout on receipt or journal, 24-hour system

Alarm

Key catch tone, error alarm, sentinel alarm

Memory protection battery

48-hour full charge protects memories for approximately 90 days.
 Battery should be replaced every five years.

Power supply/power consumption

See the rating plate.

Operation temperature

0°C ~ 40°C

Humidity

10 ~ 90%

Dimensions and weight

454mm (H) × 345mm (W) × 218mm (D) /6.5kg
 ...without drawer

Totalizers		Contents				
Category	No. of totalizers	Amount (10 digits)	No. of items (6 integer/3 decimal)	Count (4 digits)	No. of customers (6 digits)	Periodic totalizers
Department	Up to 15	✓	✓			✓
PLU	Up to 100	✓	✓			
Clerk	10	✓	✓	✓		✓
Hourly sales	24	✓			✓	
Monthly sales	31	✓	✓		✓	
Transaction	Variable with program	Variable with program				✓
Non ressettable grand total	3	✓ (16 digits)				
Reset counter	12			✓		
Consecutive No.	1			✓ (6 digits)		

* Specifications and design are subject to change without notice.

Index

- A**
- add-in rate tax 14
 - add-on rate tax 14
 - addition (+) 48, 68
 - alphabet key 78
 - arrangement 50, 69
- B**
- backspace key 78
 - bill copy 81
 - bottom message 24, 71
- C**
- cancel 22, 41, 43
 - cash/amount tendered 47, 65
 - change 27
 - character code 79
 - character code fixed key 78
 - character enter key 78
 - character fixed key 78
 - character keyboard 78
 - charge 23, 65
 - check 23, 35, 65
 - clearing a machine lock up 96
 - clerk 46, 54
 - clerk button 18
 - clerk interrupt 46
 - clerk lock/key 18
 - clerk name 24, 71
 - clerk number 54
 - clerk read/reset report 83
 - clerk secret number key 18
 - commercial message 24, 71
 - commission rate 54
 - consecutive number 24
 - correction 41
 - coupon 23, 49
 - credit 23, 35, 66
 - cube 70, 81
 - currency exchange 51, 69
 - customer display 21
 - customer number 81
- D**
- daily sales read/reset report 84
 - daily sales reset report 44
 - date display 26
 - date set 12
 - declaration 81
 - department 20, 23, 27, 28, 62, 76, 82
 - deposit 81
 - descriptor 71
 - discount (%-) 22, 32, 67
 - display 20
 - double size letter key 78
 - drawer 18
- E**
- eat-in 81
 - error code 94
 - error correction 22, 41
 - Euro 23, 36
- F**
- financial read report 83
 - fix total 73
 - flat PLU 81
- G**
- general control 55
 - group read/reset report 87
- H**
- high amount limit 29
 - hourly sales read/reset report 86
- I**
- indicator 21
 - individual clerk read/reset report 83
 - individual department, PLU read report 82
 - item counter 24
- J**
- journal 10, 24, 97
 - journal skip 24
- K**
- key layout 80
 - keyboard 22
- L**
- loan 40
 - logo message 24, 71

M

- machine features 55
- machine No. 24
- main display 20
- manual tax 81
- media change 22
- menu shift 81
- merchandise subtotal 81
- message 24, 71
- minus (-) 22
- mixed tender 35
- mode key 17
- mode switch 17
- money declaration 83, 85
- monthly sales 87
- monthly sales read/reset report 87
- multiplication 22, 28, 31, 70

N

- new balance 81
- no sale 22, 43, 67
- non add 22, 81

O

- open 23
- option 98

P

- paid out 23, 39, 66
- paper feed 22
- periodic sales 88
- pick up 40
- PLU 20, 22, 30, 62, 77, 82, 86
- PLU read/reset report 86
- post receipt 22, 70
- power failure 96
- premium (%+) 48, 67, 81
- preset price 29
- previous balance 81
- previous balance subtotal 81
- price 23
- program end key 78

Q

- quantity/for 70

R

- rate tax 81
- read report 82
- receipt 10, 24, 98
- receipt on/off 22
- receipt on/off switch / key 16
- received on account 23, 39, 66
- reduction (-) 33, 68
- refund 22, 38, 39
- repeat 20, 21, 27, 31
- report header 71, 74
- reset report 44, 82
- return 38
- review 81
- RF mode 38
- roll paper 16

S

- shift key 78
- Singapore tax 15
- single item 27, 31, 47
- space key 78
- special character 71, 75
- square 70, 81
- subtotal 23, 27

T

- table number 81
- takeout 81
- tax exempt 81
- tax table 13
- taxable amount 24
- taxable amount subtotal 81
- taxable status 24
- text recall 81
- time display 26
- time set 12
- tip 81
- trainee status 54
- tray total 81

V

- VAT 23, 32
- void 81

W

- wetproof cover 98

CASIO®

CASIO COMPUTER CO., LTD.
6-2, Hon-machi 1-chome
Shibuya-ku, Tokyo 151-8543, Japan

CE-T300C*E
SA0005-C